

P

Paulmann



2018 / 2019







--	--	--	--	--	--	--	--	--	--

Kunden-Nr./N° client/Klant nr.

Wir arbeiten auf der Grundlage unserer Liefer- und Zahlungsbedingungen.  
Diese erhalten Sie gerne auf Anfrage oder unter [www.paulmann.com](http://www.paulmann.com)

Toute commande implique l'acceptation de nos conditions générales de vente.  
Celles-ci sont à votre disposition sur simple demande ou sous [www.paulmann.com](http://www.paulmann.com).

Wij werken op basis van onze leverings- en betalingsvoorwaarden.  
Deze krijgt u na aanvraag of op [www.paulmann.com](http://www.paulmann.com)

006	Wohnraumleuchten Éclairages domestiques Woonkamerlampen	
095	Galeria	
103	Spotlights	
124	Wire Systems	
144	Rail Systems	
175	Function	
247	Outdoor	
298	Downlights	
397	SmartHome	
406	Lichtsteuerung / Transformatoren Domotique / transformateurs Lichtregeling / transformatoren	
415	LED-Leuchtmittel Ampoules LED LED-lampen	
451	Energiespar- / Leuchtstofflampen Ampoules fluocompactes Energiebesparende lampen / neonlampen	
457	Halogenlampen 12V Ampoules halogènes 12V Halogenlampen 12V	
461	Halogenlampen 230V Ampoules halogènes 230V Halogenlampen 230V	
467	Konventionelle Leuchtmittel Ampoules incandescentes Conventionele lampen	
475	Technische Informationen, Verzeichnisse Caractéristiques techniques, sommaire Technische informatie, lijsten	

## Alles rund ums Licht

Die Paulmann Licht GmbH mit Sitz im niedersächsischen Springe ist mit über 2500 innovativen Produkten einer der führenden Anbieter in der Lichtbranche und bietet sortimentsübergreifende Kompetenz – von Leuchten über Leuchtensysteme bis hin zum kompletten Leuchtmittelsortiment mit vielen Spezialitäten.

Paulmann-Produkte begeistern Ihre Kunden mit Licht zum Wohlfühlen, aktuellem Design und hoher Energieeffizienz.

Vertriebsniederlassungen und Vertretungen in rund 40 Ländern Europas sorgen dafür, dass die Kunden direkt vor Ort individuell betreut werden.

## Un monde de lumière

La société Paulmann Licht GmbH implantée à Springe en Basse-Saxe, Allemagne est, avec plus de 2500 produits innovants, l'un des plus grands distributeurs de luminaires et offre une compétence dépassant le simple cadre de sa gamme de produits – depuis les lampes jusqu'aux assortiments complets d'ampoules aux caractéristiques variées en passant par les systèmes lumineux.

Les produits Paulmann offrent un éclairage confortable, un design actuel et de hautes performances énergétiques ravissent nos clients.

Les succursales et représentations commerciales, présentes dans environ 40 pays d'Europe permettent aux clients de bénéficier d'une prestation individuelle de conseil et de suivi directement sur place.

## Alles rond het thema licht

De firma Paulmann Licht GmbH is gevestigd in Springe (Duitse deelstaat Nedersaksen), en is met meer dan 2500 innovatieve producten een van de toonaangevende aanbieders in de lichtbranche. Bovendien staat de firma garant voor een competentie die ver boven het assortiment uitgaat - van armaturen, verlichtingssystemen tot een compleet assortiment verlichtingsmiddelen met een grote keuze aan specialiteiten.

Paulmann producten wekken bij de klanten enthousiasme op met licht voor de gezelligheid, met modern design en een hoge energie-efficiëntie.

Vestigingen en vertegenwoordigingen in ongeveer 40 landen in Europa zorgen ervoor, dat de klanten direct ter plekke individueel worden geholpen.



New

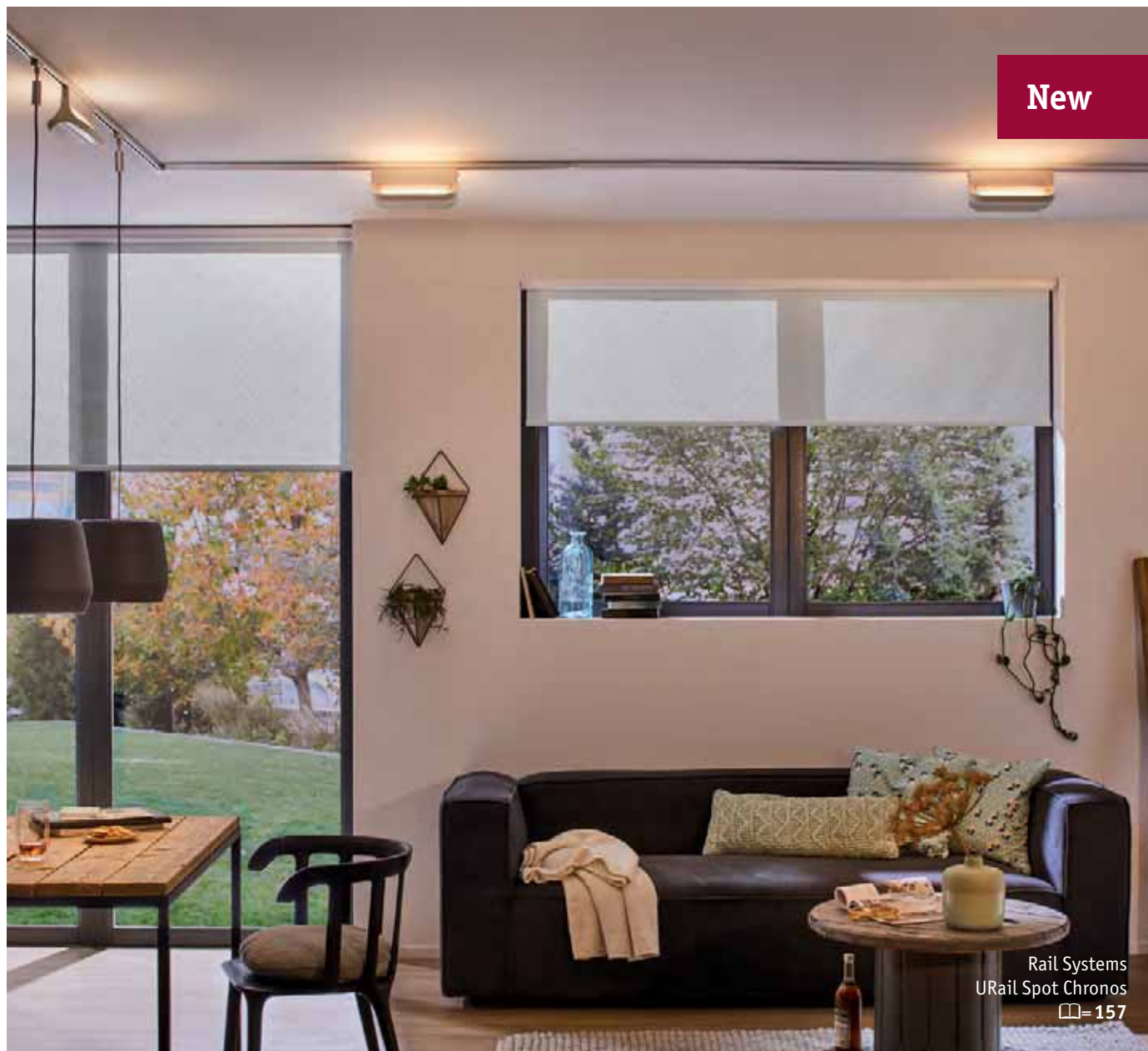

Rail Systems  
URail Spot Chronos  
□= 157

New



Downlights  
□= 298

New



Function  
□= 175



**New**

Wire Systems  
2Line  
□= 125



**New**

Favia  
□= 85



**New**

Function  
FlexLED 3D  
□= 209



**New**

Living room  
□= 44 - 94



**New**

Outdoor Mobile  
Placido  
☐= 266



**New**

Outdoor Mobile  
Clutch Sound  
☐= 268



**New**

Outdoor Mobile  
☐= 263-272



**New**

Outdoor  
Plug & Shine  
☐= 247-262



**New**

Downlights  
Panel  
☐= 363-373

# Wall & Ceiling

- 07 Wall & Ceiling
- 22 Bathroom

# Living room

- 44 Neordic
- 80 Technical design
- 88 Classic
- 93 Table



17 Argun



30 Sabik



15 Ardora



44 Living room





⌚ Chrom matt 

--	--	--	--

 Kunststoff  
 ⌚ Chrome mat 

--	--	--	--

 Matière plastique  
 ⌚ Chroom mat 

--	--	--	--

 Kunststof



**Atria** A++-A

incl. 1x18,5 W  
 1.500 lm, 2.700 K  
 230 V  
 ⌀20 ⌀220 mm  
 EAN 4000870 708644  
**708.64**

LED  
□  
R, C



**Atria** A++-A

incl. 1x15 W  
 1.500 lm, 4.000 K  
 230 V  
 ⌀20 ⌀220 mm  
 EAN 4000870 709337  
**709.33 new**

LED  
□



**Atria** A++-A

incl. 1x22 W  
 1.800 lm, 2.700 K  
 230 V  
 ⌀20 ⌀300 mm  
 EAN 4000870 708651  
**708.65**

LED  
□  
R, C



**Atria** A++-A

incl. 1x19 W  
 1.800 lm, 4.000 K  
 230 V  
 ⌀20 ⌀300 mm  
 EAN 4000870 709344  
**709.34 new**

LED  
□



⌚ Chrom matt 

--	--	--	--

 Kunststoff  
 ⌚ Chrome mat 

--	--	--	--

 Matière plastique  
 ⌚ Chroom mat 

--	--	--	--

 Kunststof



**Atria** A++-A

incl. 1x20 W  
 1.500 lm, 2.700 K  
 230 V  
 ⌀20 ⇔220 ↻220 mm  
 EAN 4000870 708668  
**708.66**

LED  
□  
R, C



**Atria** A++-A

incl. 1x16 W  
 1.500 lm, 4.000 K  
 230 V  
 ⌀20 ⇔220 ↻220 mm  
 EAN 4000870 709351  
**709.35 new**

LED  
□



**Atria** A++-A

incl. 1x24 W  
 1.800 lm, 2.700 K  
 230 V  
 ⌀20 ⇔300 ↻300 mm  
 EAN 4000870 708675  
**708.67**

LED  
□  
R, C



**Atria** A++-A

incl. 1x20 W  
 1.800 lm, 4.000 K  
 230 V  
 ⌀20 ⇔300 ↻300 mm  
 EAN 4000870 709368  
**709.36 new**

LED  
□



- 🌀 Weiß matt 📦 Kunststoff
- 🌀 Blanc dépoli 📦 Matière plastique
- 🌀 Wit mat 📦 Kunststof



**Atria** A++-A  
 incl. 1x18,5 W  
 1.500 lm, 2.700 K  
 230 V  
 ⚡20 ⌀220 mm  
 EAN 4000870 708682  
**708.68**



**Atria** A++-A  
 incl. 1x15 W  
 1.500 lm, 4.000 K  
 230 V  
 ⚡20 ⌀220 mm  
 EAN 4000870 709375  
**709.37 new**



**Atria** A++-A  
 incl. 1x22 W  
 1.800 lm, 2.700 K  
 230 V  
 ⚡20 ⌀300 mm  
 EAN 4000870 708699  
**708.69**



- 🌀 Weiß matt 📦 Kunststoff
- 🌀 Blanc dépoli 📦 Matière plastique
- 🌀 Wit mat 📦 Kunststof



**Atria** A++-A  
 incl. 1x20 W  
 1.500 lm, 2.700 K  
 230 V  
 ⚡20 ⇔220 ↻220 mm  
 EAN 4000870 708705  
**708.70**



**Atria** A++-A  
 incl. 1x16 W  
 1.500 lm, 4.000 K  
 230 V  
 ⚡20 ⇔220 ↻220 mm  
 EAN 4000870 709382  
**709.38 new**



**Atria** A++-A  
 incl. 1x24 W  
 1.800 lm, 2.700 K  
 230 V  
 ⚡20 ⇔300 ↻300 mm  
 EAN 4000870 708712  
**708.71**



**Atria** A++-A  
 incl. 1x20 W  
 1.800 lm, 4.000 K  
 230 V  
 ⚡20 ⇔300 ↻300 mm  
 EAN 4000870 709399  
**709.39 new**





⌚ Roségold 🗪 Kunststoff  
 ⌚ Or rose 🗪 Matière plastique  
 ⌚ Rosé goud 🗪 Kunststof

**Atria**

A++-A

incl. 1x22 W  
 1.800 lm, 2.700 K  
 230 V  
 ⌀20 ø300 mm  
 EAN 4000870 708729  
**708.72**

LED



R, C

**Atria**

A++-A

incl. 1x19 W  
 1.800 lm, 4.000 K  
 230 V  
 ⌀20 ø300 mm  
 EAN 4000870 709405  
**709.40 new**

LED



⌚ Roségold 🗪 Kunststoff  
 ⌚ Or rose 🗪 Matière plastique  
 ⌚ Rosé goud 🗪 Kunststof

**Atria**

A++-A

incl. 1x24 W  
 1.800 lm, 2.700 K  
 230 V  
 ⌀20 ⇔300 ↻300 mm  
 EAN 4000870 708736  
**708.73**

LED



R, C

**Atria**

A++-A

incl. 1x20 W  
 1.800 lm, 4.000 K  
 230 V  
 ⌀20 ⇔300 ↻300 mm  
 EAN 4000870 709412  
**709.41 new**

LED





- 🌀 Weiß matt 

--

 Kunststoff
- 🌀 Blanc dépoli 

--

 Matière plastique
- 🌀 Wit mat 



--





 Kunststof

 **not incl.**  
**Remote Control**  
☐= 400  
 **Bluetooth®**









**Nox** A++-A

incl. 1×10,5 W  
1.090 lm, 2.700 - 6.500 K  
230 V, incl.  10,5 VA  
ø170  40 mm  
EAN 4000870 500088  
**500.08**



- 
- 
- 
- 
- 





**Nox** A++-A

incl. 1×14 W  
1.490 lm, 2.700 - 6.500 K  
230 V, incl.  14,5 VA  
ø220  40 mm  
EAN 4000870 500095  
**500.09**

- 
- 
- 
- 
- 

**Nox** A++-A

incl. 1×21 W  
2.100 lm, 2.700 - 6.500 K  
230 V, incl.  21 VA  
ø300  40 mm  
EAN 4000870 500101  
**500.10**

- 
- 
- 
- 
- 



- 🌀 Chrom matt 𠂆 Kunststoff
- 🌀 Chrome mat 𠂆 Matière plastique
- 🌀 Chroom mat 𠂆 Kunststof



not incl.  
Remote Control  
□= 402  
**ZigBee**



**Cesena** A++-A  
incl. 1x9 W  
740lm, 2.700 K  
⊘ 116°  
230 V  
ø170 ⚡40 mm  
EAN 4000870 500859  
**500.85**

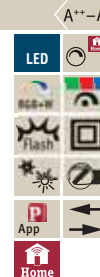

**Cesena** A++-A  
incl. 1x9,5 W  
790lm, 2.700 K  
⊘ 116°  
230 V  
ø225 ⚡40 mm  
EAN 4000870 500866  
**500.86**

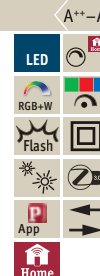

**Cesena** A++-A  
incl. 1x15 W  
1.250lm, 2.700 K  
⊘ 116°  
230 V  
ø300 ⚡40 mm  
EAN 4000870 500873  
**500.87**

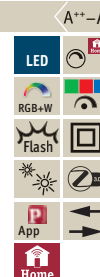

- 🌀 Weiß matt 𠂆 Kunststoff
- 🌀 Blanc dépoli 𠂆 Matière plastique
- 🌀 Wit mat 𠂆 Kunststof

not incl.  
Remote Control  
□= 402  
**ZigBee**



**Cesena** A++-A  
incl. 1x9 W  
1.050lm, 2.700 - 6.500 K  
⊘ 116°  
230 V  
ø170 ⚡40 mm  
EAN 4000870 500828  
**500.82**

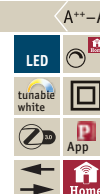



**Cesena** A++-A  
incl. 1x11 W  
1.300lm, 2.700 - 6.500 K  
⊘ 116°  
230 V  
ø225 ⚡40 mm  
EAN 4000870 500835  
**500.83**



**Cesena** A++-A  
incl. 1x16 W  
1.900lm, 2.700 - 6.500 K  
⊘ 116°  
230 V  
ø300 ⚡40 mm  
EAN 4000870 500842  
**500.84**





- 🌀 Chrom matt  Alu
- 🌀 Chrome mat  Alu
- 🌀 Chroom mat  Alu



**Lunar** A++-A  
 incl. 1x11 W  
 1.230 lm, 3.000 K  
 230 V, incl.  12,6 VA  
 ø170  $\varnothing$ 38 mm  
 EAN 4000870 706534  
**706.53**



**Lunar** A++-A  
 incl. 1x15,5 W  
 1.520 lm, 3.000 K  
 230 V, incl.  19,2 VA  
 ø225  $\varnothing$ 38 mm  
 EAN 4000870 706541  
**706.54**





**Lunar** A++-A  
 incl. 1x17 W  
 1.700 lm, 3.000 K  
 230 V, incl.  19,2 VA  
 ø300  $\varnothing$ 38 mm  
 EAN 4000870 706558  
**706.55**



**Lunar** A++-A  
 incl. 1x21,8 W  
 2.400 lm, 3.000 K  
 230 V, incl.  24,6 VA  
 ø400  $\varnothing$ 39 mm  
 EAN 4000870 706565  
**706.56**



- 🌀 Chrom matt  Alu
- 🌀 Chrome mat  Alu
- 🌀 Chroom mat  Alu



**Lunar** A++-A  
 incl. 1x11 W  
 1.230 lm, 3.000 K  
 230 V, incl.  12,6 VA  
 $\updownarrow$ 170  $\leftrightarrow$ 170  $\varnothing$ 38 mm  
 EAN 4000870 706480  
**706.48**



**Lunar** A++-A  
 incl. 1x15,4 W  
 1.520 lm, 3.000 K  
 230 V, incl.  19,2 VA  
 $\updownarrow$ 225  $\leftrightarrow$ 225  $\varnothing$ 38 mm  
 EAN 4000870 706497  
**706.49**



**Lunar** A++-A  
 incl. 1x18 W  
 1.700 lm, 3.000 K  
 230 V, incl.  19,2 VA  
 $\updownarrow$ 300  $\leftrightarrow$ 300  $\varnothing$ 38 mm  
 EAN 4000870 706503  
**706.50**





**Lunar** A++-A  
 incl. 1x21,8 W  
 2.400 lm, 3.000 K  
 230 V, incl.  24,6 VA  
 $\updownarrow$ 400  $\leftrightarrow$ 400  $\varnothing$ 39 mm  
 EAN 4000870 706510  
**706.51**



**Lunar** A++-A  
 incl. 1x27,4 W  
 3.050 lm, 3.000 K  
 230 V, incl.  30,1 VA  
 $\updownarrow$ 600  $\leftrightarrow$ 600  $\varnothing$ 39 mm  
 EAN 4000870 706527  
**706.52**







- ↳ Weiß matt  Alu
- ↳ Blanc dépoli  Alu
- ↳ Wit mat  Alu





**Lunar** A++-A

incl. 1×11 W  
 1.230 lm, 3.000 K  
 230 V, incl.  14,5 VA  
 ø170 ↗38 mm  
 EAN 4000870 706411  
**706.41**

 



**Lunar** A++-A

incl. 1×15,5 W  
 1.520 lm, 3.000 K  
 230 V, incl.  17,5 VA  
 ø225 ↗38 mm  
 EAN 4000870 706428  
**706.42**



 

**Lunar** A++-A

incl. 1×17 W  
 1.700 lm, 3.000 K  
 230 V, incl.  17,2 VA  
 ø300 ↗38 mm  
 EAN 4000870 706435  
**706.43**

 





- ↳ Weiß matt  Alu
- ↳ Blanc dépoli  Alu
- ↳ Wit mat  Alu





**Lunar** A++-A

incl. 1×11 W  
 1.230 lm, 3.000 K  
 230 V, incl.  12,6 VA  
 ⚡170 ⇔170 ↗38 mm  
 EAN 4000870 706442  
**706.44**

 



**Lunar** A++-A

incl. 1×15,4 W  
 1.520 lm, 3.000 K  
 230 V, incl.  19,2 VA  
 ⚡225 ⇔225 ↗38 mm  
 EAN 4000870 706459  
**706.45**

 



**Lunar** A++-A

incl. 1×18 W  
 1.700 lm, 3.000 K  
 230 V, incl.  19,2 VA  
 ⚡300 ⇔300 ↗38 mm  
 EAN 4000870 706466  
**706.46**

**Lunar** A++-A

incl. 1×27,4 W  
 3.050 lm, 3.000 K  
 230 V, incl.  30,1 VA  
 ⚡600 ⇔600 ↗39 mm  
 EAN 4000870 706473  
**706.47**



🖱️ Weiß 🗪 Metall  
 🖱️ Blanc 🗪 Métal  
 🖱️ Wit 🗪 Metaal



**Sol** A++-A

incl. 1×4,2 / 1×2,8 W  
 440 + 380 lm, 2.700 K  
 ø195 ↗40 mm  
 EAN 4000870 707357  
**707.35**

LED 🗪

**Sol** A++-A

incl. 1×8 / 1×4,2 W  
 970 + 445 lm, 2.700 K  
 ø245 ↗40 mm  
 EAN 4000870 707364  
**707.36**

LED 🗪



🖱️ Weiß 🗪 Metall  
 🖱️ Blanc 🗪 Métal  
 🖱️ Wit 🗪 Metaal



**Sol** A++-A

incl. 1×4,2 / 1×2,8 W  
 558 + 312 lm, 2.700 K  
 ⚡195 ⇄195 ↗40 mm  
 EAN 4000870 707326  
**707.32**

LED 🗪

**Sol** A++-A

incl. 1×8 / 1×4,2 W  
 950 + 440 lm, 2.700 K  
 ⚡245 ⇄245 ↗40 mm  
 EAN 4000870 707333  
**707.33**

LED 🗪



🖱️ Weiß 🗪 Metall  
 🖱️ Blanc 🗪 Métal  
 🖱️ Wit 🗪 Metaal



**Sol** A++-A

incl. 1×9,4 / 1×4,6 W  
 830 + 100 lm, 2.700 K  
 CR 2025 × 1  
 incl. ⚡12 VA  
 ⚡245 ⇄245 ↗40 mm  
 EAN 4000870 707340  
**707.34**

LED 🗪



🖱️ Weiß 🗪 Metall  
 🖱️ Blanc 🗪 Métal  
 🖱️ Wit 🗪 Metaal



**Sol** A++-A

incl. 1×9,4 / 1×4,6 W  
 855 + 85 lm, 2.700 K  
 CR 2025 × 1  
 incl. ⚡12 VA  
 ø245 ↗40 mm  
 EAN 4000870 707371  
**707.37**







LED 🗪













 **not incl.**  
**Remote Control**  
□ = 400  
 **Bluetooth®**



-  Weiß  Metall/Kunststoff
-  Blanc  Métal/Matière plastique
-  Wit  Metaal/Kunststof







**Ardora** A++-A

incl. 1x33 W  
3.096 lm, 2.700 - 6.500 K  
230 V  
⌀85,5 ø450 mm  
EAN 4000870 709054  
**709.05 new**

-  LED
-  tunable white
-  App
-  Bluetooth
-  Remote Control
- 



-  1x click  
100%
-  2x click  
50%
-  3x click  
25%

-  Weiß  Metall/Kunststoff
-  Blanc  Métal/Matière plastique
-  Wit  Metaal/Kunststof

**Ardora** A++-A

incl. 1x31 W  
3.074 lm, 2.700 K  
230 V  
⌀85,5 ø450 mm  
EAN 4000870 709061  
**709.06 new**

-  LED
-  dimmable
-  App



-  Light functions only over Remote Control
- 
- 

Play music over your Smartphone  
 **Bluetooth®**

-  Weiß  Kunststoff
-  Blanc  Matière plastique
-  Wit  Kunststof

**Accento** A++-A

incl. 1x22 / 1x3 W  
2.150 lm, 3.000 - 6.500 K  
AAA/1,5V (Micro) x 2  
230 V  
ø340 ⌀85 mm  
EAN 4000870 706220  
**706.22**



-  LED
-  tunable white
-  IP44
-  App
-  Battery
-  Bluetooth
-  Sound



**Costella**

incl. 1x16 W  
1.500 lm, 2.700 - 6.500 K  
230 V  
⌀70 ø340 mm  
EAN 4000870 709016  
**709.01 new**

A++-A



1x click 6500 K  
2x click 2700 K  
3x click 4000 K

Wei Acryl/Metall  
Blanc Acryl/Mtal  
Wit Acryl/Metaal



**Costella**

incl. 1x16 W  
1.500 lm, 2.700 - 6.500 K  
230 V  
⌀70 ⇄330 ⚡330 mm  
EAN 4000870 709023  
**709.02 new**

A++-A



1x click 6500 K  
2x click 2700 K  
3x click 4000 K

Wei Acryl/Metall  
Blanc Acryl/Mtal  
Wit Acryl/Metaal



**Costella**

incl. 1x22 W  
2.000 lm, 2.700 - 6.500 K  
230 V  
⌀95 ø450 mm  
EAN 4000870 709047  
**709.04 new**

A++-A



1x click 6500 K  
2x click 2700 K  
3x click 4000 K

Wei Acryl/Metall  
Blanc Acryl/Mtal  
Wit Acryl/Metaal



**Costella**

incl. 1x22 W  
2.000 lm, 2.700 - 6.500 K  
230 V  
⌀70 ⇄430 ⚡430 mm  
EAN 4000870 709030  
**709.03 new**

A++-A



1x click 6500 K  
2x click 2700 K  
3x click 4000 K

Wei Acryl/Metall  
Blanc Acryl/Mtal  
Wit Acryl/Metaal



- Alu gebürstet Metall
- Alu brossé Métal
- Alu geborsteld Metaal

**Argun** A++-A

incl. 1x4,8W  
475 lm, 3.000 K  
230V  
⌀60 ø97 mm  
EAN 4000870 797082  
**797.08 new**

**Argun** A++-A

incl. 2x4,8W  
2x475 lm, 3.000 K  
230V  
⌀60 ⇔189 ↗97 mm  
EAN 4000870 797099  
**797.09 new**

**Argun** A++-A

incl. 3x4,8W  
3x475 lm, 3.000 K  
230V  
⌀60 ⇔284 ↗97 mm  
EAN 4000870 797105  
**797.10 new**

**Argun** A++-A

incl. 4x4,8W  
4x475 lm, 3.000 K  
230V  
⌀60 ⇔189 ↗189 mm  
EAN 4000870 797112  
**797.11 new**



- Weiß matt/Chrom Metall
- Blanc dépoli/Chrome Métal
- Wit mat/Chroom Metaal



**Liao** A++-A

incl. 1x4,7W  
430 lm, 3.000 K  
↘ 110°  
230V  
⌀33 ø125 mm  
EAN 4000870 709429  
**709.42 new**

**Liao** A++-A

incl. 2x4,7W  
2x430 lm, 3.000 K  
↘ 110°  
230V  
⌀33 ⇔230 ↗110 mm  
EAN 4000870 709436  
**709.43 new**

**Liao** A++-A

incl. 3x4,7W  
3x430 lm, 3.000 K  
↘ 110°  
230V  
⌀33 ⇔350 ↗110 mm  
EAN 4000870 709443  
**709.44 new**

**Liao** A++-A

incl. 4x4,7W  
4x430 lm, 3.000 K  
↘ 110°  
230V  
⌀33 ⇔230 ↗230 mm  
EAN 4000870 709450  
**709.45 new**



- 🔗 Blau  Stoff
- 🔗 Bleu  Tissus
- 🔗 Blauw  Textiel

💡 285.02



**Mea** A++-E  
 max. 20 W, E14  
 230 V  
 ⚡ 160 ø250 mm  
 EAN 4000870 709498  
**709.49 new**



- 🔗 Beige  Stoff
- 🔗 Beige  Tissus
- 🔗 Beige  Textiel

💡 285.02



**Mea** A++-E  
 max. 20 W, E14  
 230 V  
 ⚡ 160 ø250 mm  
 EAN 4000870 709504  
**709.50 new**



- 🔗 Blau  Stoff
- 🔗 Bleu  Tissus
- 🔗 Blauw  Textiel

💡 283.31  
283.32



**Mari** A++-E  
 max. 2×20 W, E27  
 230 V  
 ⚡ 130 ø380 mm  
 EAN 4000870 709511  
**709.51 new**



- 🔗 Beige  Stoff
- 🔗 Beige  Tissus
- 🔗 Beige  Textiel

💡 283.31  
283.32



**Mari** A++-E  
 max. 2×20 W, E27  
 230 V  
 ⚡ 130 ø380 mm  
 EAN 4000870 709528  
**709.52 new**



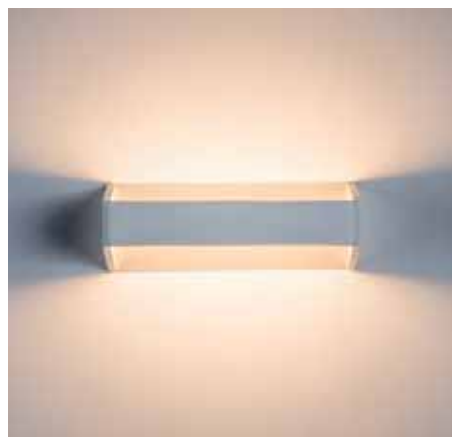

**Bar** A++-A  
 incl. 1x5,5 W  
 765 lm, 2.700 K  
 230 V, incl.  $\text{⊖}$  6 VA  
 $\text{⌀}$ 70  $\text{⇔}$ 200  $\text{⌀}$ 100 mm  
 EAN 4000870 707906  
**707.90**



- Weiß Alu
- Blanc Alu
- Wit Alu



**Bar** A++-A  
 incl. 1x5,5 W  
 765 lm, 2.700 K  
 230 V, incl.  $\text{⊖}$  6 VA  
 $\text{⌀}$ 70  $\text{⇔}$ 200  $\text{⌀}$ 100 mm  
 EAN 4000870 707999  
**707.99**

- Grau/Silber Alu
- Gris/Argent Alu
- Grijs/Zilver Alu



**Bar** A++-A  
 incl. 1x5,5 W  
 765 lm, 2.700 K  
 230 V, incl.  $\text{⊖}$  6 VA  
 $\text{⌀}$ 70  $\text{⇔}$ 200  $\text{⌀}$ 100 mm  
 EAN 4000870 707982  
**707.98**

- Weiß/Gold Alu
- Blanc/Doré Alu
- Wit/Goud Alu



**Bar** A++-A  
 incl. 1x10,5 W  
 1.500 lm, 2.700 K  
 230 V, incl.  $\text{⊖}$  12 VA  
 $\text{⌀}$ 70  $\text{⇔}$ 400  $\text{⌀}$ 100 mm  
 EAN 4000870 707913  
**707.91**

- Weiß Alu
- Blanc Alu
- Wit Alu



**Bocca**

A++-A

incl. 2x3 W  
2x320 + 320 lm, 2.700 K  
230 V, incl.  $\text{⊖}$  6 VA  
⌀100 ⇄140 ⌀52 mm  
EAN 4000870 707920  
**707.92**

LED



- 🔗 Weiß  $\text{⊞}$  Alu
- 🔗 Blanc  $\text{⊞}$  Alu
- 🔗 Wit  $\text{⊞}$  Alu



**Tulip**

A++-A

incl. 1x3 W  
420 lm, 2.700 K  
230 V, incl.  $\text{⊖}$  3,6 VA  
⌀95 ⇄140 ⌀52 mm  
EAN 4000870 707937  
**707.93**

LED



- 🔗 Weiß  $\text{⊞}$  Alu
- 🔗 Blanc  $\text{⊞}$  Alu
- 🔗 Wit  $\text{⊞}$  Alu

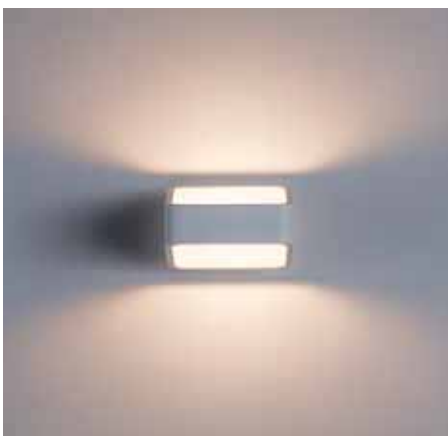

**Stadio**

A++-A

incl. 1x5,5 W  
730 lm, 2.700 K  
230 V, incl.  $\text{⊖}$  6 VA  
⌀70 ⇄103 ⌀138 mm  
EAN 4000870 707968  
**707.96**

LED



- 🔗 Weiß  $\text{⊞}$  Alu
- 🔗 Blanc  $\text{⊞}$  Alu
- 🔗 Wit  $\text{⊞}$  Alu



**Anello**

incl. 1x6,5W  
870 lm, 2.700 K  
230V, incl.  $\pm$  8 VA  
 $\varnothing$ 31  $\times$ 300  $\times$ 141 mm  
EAN 4000870 707951  
**707.95**

A++-A

LED



$\pm$



- Weiß Alu
- Blanc Alu
- Wit Alu



**Scena**

incl. 4x2,5W  
4x330 + 330 lm, 2.700 K  
230V, incl.  $\pm$  12 VA  
 $\varnothing$ 90  $\times$ 210  $\times$ 105 mm  
EAN 4000870 707944  
**707.94**

A++-A

LED



$\pm$

- Weiß Alu
- Blanc Alu
- Wit Alu



**DecoBeam**

incl. 1x2,5W  
93 lm, 3.000 K  
230V  
 $\varnothing$ 103  $\times$ 54 mm  
EAN 4000870 702918  
**702.91**

A++-A

LED



**DecoBeam**

incl. 1x3,5W  
330 lm, 3.000 K  
230V, incl.  $\pm$  7 VA  
 $\varnothing$ 150  $\times$ 54 mm  
EAN 4000870 707203  
**707.20**

A++-A

LED



**DecoBeam**

incl. 1x4,5W  
451 lm, 3.000 K  
230V, incl.  $\pm$  7 VA  
 $\varnothing$ 250  $\times$ 54 mm  
EAN 4000870 707210  
**707.21**

A++-A

LED



- Chrom/Chrom matt/Transparent Metall/  
Acryl
- Chrome/Chrome mat/Transparent Métal/  
Acryl
- Chroom/Chroom mat/Transparant  
 Metaal/Acryl

**Ivy**

incl. 1×14 W  
 1.640 lm, 2.700 K  
 230 V, incl. ⚡ 15 VA  
 ø300 ↗40 mm  
 EAN 4000870 706862  
**706.86**

A++-A

LED

Bajonett

**Ivy**

incl. 1×20 W  
 2.296 lm, 2.700 K  
 230 V, incl. ⚡ 20 VA  
 ø380 ↗40 mm  
 EAN 4000870 706879  
**706.87**

A++-A

LED

Bajonett

- 🔗 Chrom matt 🏠 Kunststoff
- 🔗 Chrome mat 🏠 Matière plastique
- 🔗 Chroom mat 🏠 Kunststof



**Ivy**

A++-A

incl. 1x14 W  
1.640 lm, 2.700 K  
230 V, incl.  $\text{⊖}$  15 VA  
⌀300 ⇄300 ⌀40 mm  
EAN 4000870 706886  
**706.88**

LED

IP44



Bajonett

**Ivy**

A++-A

incl. 1x20 W  
2.296 lm, 2.700 K  
230 V, incl.  $\text{⊖}$  20 VA  
⌀380 ⇄380 ⌀40 mm  
EAN 4000870 706893  
**706.89**

LED

IP44



Bajonett

- ⌘ Chrom matt Kunststoff
- ⌘ Chrome mat Matière plastique
- ⌘ Chroom mat Kunststof

**Beam**

A++-A

incl. 1x13,5 / 1x2 W  
1.476 + 247 lm, 2.700 K  
230 V, incl.  $\text{⊖}$  20 VA  
ø300 ⌀42 mm  
EAN 4000870 706923  
**706.92**

LED

IP44



Bajonett

- ⌘ Chrom Kunststoff
- ⌘ Chrome Matière plastique
- ⌘ Chroom Kunststof

**Beam**

A++-A

incl. 1x13,5 / 1x2 W  
1.476 + 247 lm, 2.700 K  
230 V, incl.  $\text{⊖}$  20 VA  
⌀300 ⇄300 ⌀40 mm  
EAN 4000870 706916  
**706.91**

LED

IP44



Bajonett

- ⌘ Chrom Kunststoff
- ⌘ Chrome Matière plastique
- ⌘ Chroom Kunststof



- Chrom Kunststoff
- Chrome Matière plastique
- Chroom Kunststof



**Aviar**

A++-A

incl. 1x20 W  
 2.400 lm, 2.700 K  
 230 V  
 ø300 ↗62 mm  
 EAN 4000870 708828  
**708.82**

LED

IP44



- Chrom Metall/Kunststoff
- Chrome Métal/Matière plastique
- Chroom Metaal/Kunststof



**Doradus**

A++-A

incl. 3x4,7 W  
 3x421 lm, 3.000 K  
 230 V  
 ø250 ↗42 mm  
 EAN 4000870 708743  
**708.74**

LED

IP23



- Chrom Metall/Kunststoff
- Chrome Métal/Matière plastique
- Chroom Metaal/Kunststof



**Doradus**

A++-A

incl. 4x5 W  
 4x430 lm, 3.000 K  
 230 V  
 ⚡250 ↔250 ↗42 mm  
 EAN 4000870 708750  
**708.75**

LED

IP23





⌘ Satin Acryl  
 ⌘ Satiné Acryl  
 ⌘ Satijn Acryl

**Minor**

A++-A

incl. 4×4,5 W  
 4×1.000 lm, 3.000 K  
 230 V, incl. 25 VA  
 ø230 ↗42 mm  
 EAN 4000870 705094  
**705.09**

LED

IP44



⌘ Satin Acryl  
 ⌘ Satiné Acryl  
 ⌘ Satijn Acryl

**Minor**

A++-A

incl. 4×4,5 W  
 4×1.000 lm, 3.000 K  
 230 V, incl. 25 VA  
 ↕230 ⇄230 ↗42 mm  
 EAN 4000870 705087  
**705.08**

LED

IP44



⌘ Chrom/Weiß/Klar Metall/Acryl  
 ⌘ Chrome/Blanc/Clair Métal/Acryl  
 ⌘ Chroom/Wit/Helder Metaal/Acryl

**Pollux**

A++-A

incl. 1×14 W  
 750 lm, 3.000 K  
 230 V, incl. 19 VA  
 ø320 ↗60 mm  
 EAN 4000870 704677  
**704.67**

LED

IP44





Wei Kunststoff  
Blanc Matire plastique  
Wit Kunststof



Leonis

A++-A

incl. 1x9,5 W  
1.200 lm, 2.700 K  
230 V, incl. -14,5 VA  
ø280 295 mm  
EAN 4000870 707227  
**707.22**



Leonis

A++-A

incl. 1x11 W  
1.350 lm, 2.700 K  
230 V, incl. -14,5 VA  
ø330 3106 mm  
EAN 4000870 707234  
**707.23**

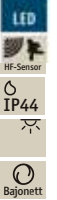

Wei Kunststoff  
Blanc Matire plastique  
Wit Kunststof



Leonis

A++-A

incl. 1x9,5 W  
1.200 lm, 4.000 K  
230 V, incl. -14,5 VA  
ø280 295 mm  
EAN 4000870 707241  
**707.24**



Leonis

A++-A

incl. 1x11 W  
1.350 lm, 4.000 K  
230 V, incl. -14,5 VA  
ø330 3106 mm  
EAN 4000870 707258  
**707.25**



Chrom/Wei Metall/Acryl  
Chrome/Blanc Mtal/Acryl  
Chroom/Wit Metaal/Acryl



Biabo

A++-E

max. 18 W, E27  
230 V  
ø250 2105 mm  
EAN 4000870 708040  
**708.04**



283.31  
283.77



400.28



### Arctus

max. 60 W, E27  
230 V  
ø275 ø80 mm  
EAN 4000870 703441

**703.44**

Eisen gebürstet/Opak Metall/Glas  
 Acier brossé/Opaque Métal/Verre  
 Staal geborsteld/Opaak Metaal/Glas

A++-E

IP44



### Arctus

max. 60 W, E27  
230 V  
ø275 ø80 mm  
EAN 4000870 703458

**703.45**

Chrom/Opak Metall/Glas  
 Chrome/Opaque Métal/Verre  
 Chroom/Opaak Metaal/Glas

A++-E

IP44



### Arctus

max. 60 W, E27  
230 V  
ø275 ø80 mm  
EAN 4000870 703434

**703.43**

Weiß/Opak Metall/Glas  
 Blanc/Opaque Métal/Verre  
 Wit/Opaak Metaal/Glas

A++-E

IP44



Eisen gebürstet/Weiß Metall/Acryl  
 Acier brossé/Blanc Métal/Acryl  
 Staal geborsteld/Wit Metaal/Acryl

283.31  
283.77



### Ixa

max. 18 W, E27  
230 V  
ø310 ø110 mm  
EAN 4000870 708057

**708.05**

A++-E

IP44



Bajonett



**Falima**

max. 18 W, E27  
230 V  
ø260  $\varnothing$ 105 mm  
EAN 4000870 708064  
**708.06**

A++-E

IP44



Bajonett

⌘ Chrom/Weiß ⌘ Metall/Acryl  
⌘ Chrome/Blanc ⌘ Métal/Acryl  
⌘ Chroom/Wit ⌘ Metaal/Acryl

💡 283.31  
283.77





- Chrom Metall/Kunststoff
- Chrome Métal/Matière plastique
- Chroom Metaal/Kunststof

**Doradus**

A++-A

incl. 2×4,7 W  
2×421 lm, 3.000 K  
230 V  
⌀95 ⇄230 ⌀42 mm  
EAN 4000870 708835  
**708.83**

LED

IP23

**Doradus**

A++-A

incl. 3×4,7 W  
3×421 lm, 3.000 K  
230 V  
⌀95 ⇄350 ⌀42 mm  
EAN 4000870 708767  
**708.76**

LED

IP23



- Alu/Klar Metall/Acryl
- Alu/Clair Métal/Acryl
- Alu/Helder Metaal/Acryl

**Theta**

A++-A

incl. 1×9 W  
440 lm, 3.000 K  
230 V, incl. ⚡10 VA  
⌀250 ⇄100 ⌀50 mm  
EAN 4000870 704783  
**704.78**

LED

IP44

**Theta**

A++-A

incl. 1×13,5 W  
660 lm, 3.000 K  
230 V, incl. ⚡15 VA  
⌀100 ⇄400 ⌀50 mm  
EAN 4000870 704790  
**704.79**

LED

IP44



- Alu/Klar Metall/Acryl
- Alu/Clair Métal/Acryl
- Alu/Helder Metaal/Acryl

**Tucana**

A++-A

incl. 1×4,5 W  
220 lm, 3.000 K  
230 V, incl. ⚡8,4 VA  
⌀225 ⇄100 ⌀120 mm  
EAN 4000870 704721  
**704.72**

LED

IP44

**Tucana**

A++-A

incl. 1×9 W  
440 lm, 3.000 K  
230 V, incl. ⚡10 VA  
⌀250 ⇄100 ⌀50 mm  
EAN 4000870 704738  
**704.73**

LED

IP44

**Tucana**

A++-A

incl. 1×13,5 W  
660 lm, 3.000 K  
230 V, incl. ⚡15 VA  
⌀100 ⇄400 ⌀50 mm  
EAN 4000870 704745  
**704.74**

LED

IP44



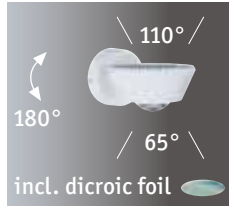

**Sabik**

A++-A

incl. 1x9 / 1x4 W  
800 + 390 lm, 2.700 K  
230 V  
∅80 ⇔117 ⇨152 mm  
EAN 4000870 709467  
**709.46 new**



- ↳ Weiß matt ▣ Kunststoff
- ↳ Blanc dépoli ▣ Matière plastique
- ↳ Wit mat ▣ Kunststof

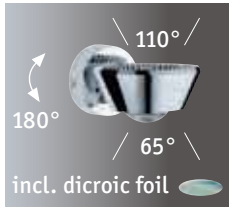

**Sabik**

A++-A

incl. 1x9 / 1x4 W  
800 + 390 lm, 2.700 K  
230 V  
∅80 ⇔117 ⇨152 mm  
EAN 4000870 709474  
**709.47 new**



- ↳ Chrom ▣ Kunststoff
- ↳ Chrome ▣ Matière plastique
- ↳ Chroom ▣ Kunststof



**Capella**

A++-A

incl. 2x3,5 W  
2x250 lm, 2.700 K  
∠ 45°  
230 V, incl. ⚡ 8 VA  
∅83 ⇔64 ⇨100 mm  
EAN 4000870 704950  
**704.95**



- ↳ Chrom ▣ Metall/Glas
- ↳ Chrome ▣ Métal/Verre
- ↳ Chroom ▣ Metaal/Glas





- ⌘ Chrom/Satin ⌘ Metall/Glas
- ⌘ Chrome/Satiné ⌘ Métal/Verre
- ⌘ Chroom/Satijn ⌘ Metaal/Glas

**Bellatrix**

A++-A

incl. 2×3,5 W

2×220 lm, 2.700 K

⊘ 90°

230 V, incl. ⚡ 8 VA

⌀48 ⇄64 ↗100 mm

EAN 4000870 704943

**704.94**

LED

IP44



- ⌘ Chrom/Weiß ⌘ Metall/Acryl
- ⌘ Chrome/Blanc ⌘ Métal/Acryl
- ⌘ Chroom/Wit ⌘ Metaal/Acryl

**Diadem**

A++-A

incl. 2×3,5 W

2×250 lm, 2.700 K

230 V, incl. ⚡ 8,4 VA

⌀160 ⇄80 ↗128 mm

EAN 4000870 704929

**704.92**

LED

IP44



- ⌘ Chrom matt/Satin ⌘ Metall/Glas
- ⌘ Chrome mat/Satiné ⌘ Métal/Verre
- ⌘ Chroom mat/Satijn ⌘ Metaal/Glas

⌘ 283.38  
⌘ 283.43

**Carina**

A++-E

max. 28 W, G9

230 V

⌀157 ø105 ⇄105 ↗115 mm

EAN 4000870 708385

**708.38**

IP44





Chrom/Satin Metall/Glas  
Chrome/Satiné Métal/Verre  
Chroom/Satijn Metaal/Glas

283.38  
283.43



**Eleon**

max. 33 W, G9  
230 V  
203 ø105 ⇄105 ↻135 mm  
EAN 4000870 708392  
**708.39**



Chrom/Satin Metall/Glas  
Chrome/Satiné Métal/Verre  
Chroom/Satijn Metaal/Glas

284.96  
284.95  
283.40



**Gemini Set**

max. 2×20 W, E14  
230 V  
195 ⇄85 ↻105 mm  
EAN 4000870 703540  
**703.54**



Chrom/Opak Metall/Glas  
Chrome/Opaque Métal/Verre  
Chroom/Opaak Metaal/Glas

284.96  
284.95  
283.40



**Lenia**

max. 2×20 W, E14  
230 V  
80 ⇄330 ↻105 mm  
EAN 4000870 703502  
**703.50**



**Agna**

A++-A

incl. 1x20 W  
1.800 lm, 2.700 K  
230 V  
⌀50 ⇄310 ⇄125 mm  
EAN 4000870 709481  
**709.48 new**

LED

IP44

R, C



Chrom/Weiß matt ▣ Alu/Edelstahl  
 Chrome/Blanc dépoli ▣ Alu/  
 Acier inoxydable  
 Chroom/Wit mat ▣ Alu/edelstaal

**Lukida**

A++-A

incl. 1x9 W  
650 lm, 3.000 K  
230 V, incl. ⇄10 VA  
⌀100 ⇄600 ⇄42 mm  
EAN 4000870 704639  
**704.63**

LED

IP44

Chrom/Weiß ▣ Alu/Acryl  
 Chrome/Blanc ▣ Alu/Acryl  
 Chroom/Wit ▣ Alu/Acryl

**Nimbus**

A++-A

incl. 1x9 W  
600 lm, 3.000 K  
230 V, incl. ⇄10 VA  
⌀68 ⇄600 ⇄63 mm  
EAN 4000870 704646  
**704.64**

LED

IP44

Chrom/Weiß ▣ Metall/Acryl  
 Chrome/Blanc ▣ Métal/Acryl  
 Chroom/Wit ▣ Metaal/Acryl



**Kuma**

A++-A

incl. 1x9 W  
660 lm, 3.000 K  
230 V, incl.  $\pm$ 10 VA  
45  $\leftrightarrow$  500 84 mm  
EAN 4000870 704707



**704.70**

- 🌀 Chrom/Weiß 🗪 Metall/Acryl
- 🌀 Chrome/Blanc 🗪 Métal/Acryl
- 🌀 Chroom/Wit 🗪 Metaal/Acryl



**Proxima**

A++-A

incl. 2x3,5 W  
2x250 lm, 2.700 K  
230 V, incl.  $\pm$ 10 VA  
70  $\leftrightarrow$  300 95 mm  
EAN 4000870 704691



**704.69**

- 🌀 Chrom/Weiß 🗪 Metall/Kunststoff
- 🌀 Chrome/Blanc 🗪 Métal/Matière plastique
- 🌀 Chroom/Wit 🗪 Metaal/Kunststof



**Proxima**

A++-A

incl. 3x3,5 W  
3x250 lm, 2.700 K  
230 V, incl.  $\pm$ 10 VA  
70  $\leftrightarrow$  500 95 mm  
EAN 4000870 704714



**704.71**



- ↳ Weiß Alu/Acryl
- ↳ Blanc Alu/Acryl
- ↳ Wit Alu/Acryl

**Arneb**

A++-A

incl. 1×9 W  
700 lm, 3.000 K  
230 V  
⌀40 ↔326 ↗78 mm  
EAN 4000870 708781  
**708.78**

LED

IP44



- ↳ Chrom Alu/Acryl
- ↳ Chrome Alu/Acryl
- ↳ Chroom Alu/Acryl

**Arneb**

A++-A

incl. 1×9 W  
700 lm, 3.000 K  
230 V  
⌀40 ↔326 ↗78 mm  
EAN 4000870 708798  
**708.79**

LED

IP44



- ↳ Chrom/Weiß Metall/Acryl
- ↳ Chrome/Blanc Métal/Acryl
- ↳ Chroom/Wit Metaal/Acryl

**Mizar**

A++-A

incl. 1×10,5 W  
1.400 lm, 3.000 K  
230 V  
⌀45 ↔630 ↗82 mm  
EAN 4000870 797167  
**797.16 new**

LED

IP44





- Chrom/Weiß Metall/Acryl
- Chrome/Blanc Métal/Acryl
- Chroom/Wit Metaal/Acryl



**Orgon** A++-A  
 incl. 1×7,5 W  
 980 lm, 3.000 K  
 230 V  
 ⌀60 ⇄440 ↗82 mm  
 EAN 4000870 797129  
**797.12 new**



**Orgon** A++-A  
 incl. 1×10,5 W  
 1.400 lm, 3.000 K  
 230 V  
 ⌀60 ⇄700 ↗82 mm  
 EAN 4000870 797136  
**797.13 new**



- Chrom/Weiß Metall/Acryl
- Chrome/Blanc Métal/Acryl
- Chroom/Wit Metaal/Acryl



**Quasar** A++-A  
 incl. 1×7,5 W  
 980 lm, 3.000 K  
 230 V  
 ⌀45 ⇄440 ↗60 mm  
 EAN 4000870 797143  
**797.14 new**



**Quasar** A++-A  
 incl. 1×10,5 W  
 1.400 lm, 3.000 K  
 230 V  
 ⌀45 ⇄700 ↗60 mm  
 EAN 4000870 797150  
**797.15 new**



- Chrom Metall
- Chrome Métal
- Chroom Metaal

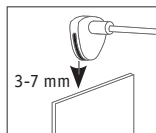

**Mintaka** A++-E  
 max. 20 W, GU10  
 230 V  
 ⌀38 ⇄56 ↗120 mm  
 EAN 4000870 708804  
**708.80**

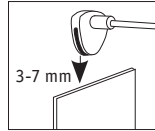

💡 282.86

**Becrux**

A++-A

incl. 1x4 W  
336 lm, 3.000 K  
230 V  
⌀93 ⇄93 ↗140 mm  
EAN 4000870 708811  
**708.81**

LED



- ⌘ Chrom ☒ Metall/Kunststoff
- ⌘ Chrome ☒ Métal/Matière plastique
- ⌘ Chroom ☒ Metaal/Kunststof

**Bela**

A++-A

incl. 1x5,7 W  
260 lm, 3.000 K  
230 V, incl. ⚡ 8,4 VA  
⌀230 ⇄230 ↗295 mm  
EAN 4000870 704684  
**704.68**

LED

IP44



On/Off

- ⌘ Chrom/Weiß/Spiegel ☒ Metall/Acryl
- ⌘ Chrome/Blanc/Miroir ☒ Métal/Acryl
- ⌘ Chroom/Wit/Spiegel ☒ Metaal/Acryl

**Bela**

A++-E

max. 40 W, E14  
230 V  
⌀235 ⇄470 ↗350 mm  
EAN 4000870 703496  
**703.49**



On/Off

- ⌘ Chrom/Spiegel ☒ Metall/Glas
- ⌘ Chrome/Miroir ☒ Métal/Verre
- ⌘ Chroom/Spiegel ☒ Metaal/Glas

💡 283.40  
860.07



Chrom/Transparent Metall/Glas  
 Chrome/Transparent Métal/Verre  
 Chroom/Transparant Metaal/Glas

283.38



**Trabani** A++-E  
 max. 20 W, G9 IP44  
 230 V   
 ⌀110 ⇄110 ⌀135 mm  
 EAN 4000870 708408  
**708.40**



**Trabani** A++-E  
 max. 2×20 W, G9 IP44  
 230 V   
 ⌀80 ⇄280 ⌀125 mm  
 EAN 4000870 708415  
**708.41**



**Trabani** A++-E  
 max. 3×20 W, G9 IP44  
 230 V   
 ø240 ⌀135 mm  
 EAN 4000870 708422  
**708.42**



Weiß/Chrom Metall  
 Blanc/Chrome Métal  
 Wit/Chroom Metaal

284.64  
 282.99  
 283.00



**Drop IP44** A++-E  
 max. 10 W, GU10 IP44  
 230 V   
 ⌀123 ø100 ⌀165 mm  
 EAN 4000870 667149  
**667.14**



**Drop IP44** A++-E  
 max. 2×10 W, GU10 IP44  
 230 V   
 ⌀165 ⇄350 ⌀65 mm  
 EAN 4000870 667156  
**667.15**



**Drop IP44** A++-E  
 max. 3×10 W, GU10 IP44  
 230 V   
 ⌀165 ø250 mm  
 EAN 4000870 667163  
**667.16**





Weiß/Chrom Metall  
 Blanc/Chrome Métal  
 Wit/Chroom Metaal

284.64  
 282.99  
 283.00

**Zyli IP44**

A++-E

max. 10 W, GU10  
 230 V  
 ø100 ↗110 mm  
 EAN 4000870 667101  
**667.10**

**Zyli IP44**

A++-E

max. 2×10 W, GU10  
 230 V  
 ⌀110 ⇔400 ↗70 mm  
 EAN 4000870 667118  
**667.11**

**Zyli IP44**

A++-E

max. 3×10 W, GU10  
 230 V  
 ⌀110 ⇔600 ↗70 mm  
 EAN 4000870 667132  
**667.13**

**Zyli IP44**

A++-E

max. 3×10 W, GU10  
 230 V  
 ⌀110 ø250 mm  
 EAN 4000870 667125  
**667.12**



Weiß/Chrom Metall  
 Blanc/Chrome Métal  
 Wit/Chroom Metaal

284.64  
 282.99  
 283.00

**Tube IP44**

A++-E

max. 10 W, GU10  
 230 V  
 ⌀138 ø100 ↗94 mm  
 EAN 4000870 667170  
**667.17**

**Tube IP44**

A++-E

max. 2×10 W, GU10  
 230 V  
 ⌀94 ⇔350 ↗65 mm  
 EAN 4000870 667187  
**667.18**

**Tube IP44**

A++-E

max. 3×10 W, GU10  
 230 V  
 ⌀94 ø250 mm  
 EAN 4000870 667194  
**667.19**





Textilkabel  
Câble en textile  
Textielkabel



1  
284.78  
283.87  
283.75



2  
284.78  
283.87  
283.75

**1 Pendulum IP44** A++-E

max. 20 W, E27  
230 V  
⌀159 cm ø104 mm  
EAN 4000870 708941  
**708.94 new**

Chrom  Metall  
Chrome  Métal  
Chroom  Metaal

A++-E  
 IP44

**2 Pendulum IP44** A++-E

max. 20 W, E27  
230 V  
⌀159 cm ø104 mm  
EAN 4000870 708965  
**708.96 new**

Schwarzchrom  Metall  
Chrome noir  Métal  
Black chroom  Metaal

A++-E  
 IP44



3

284.23  
283.77

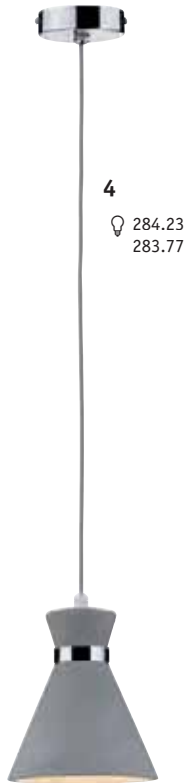

4

284.23  
283.77

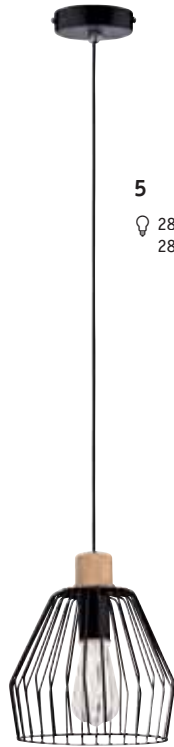

5

284.25  
283.92

### 3 Globe

max. 20 W, E27  
230 V  
173 cm ø200 mm  
EAN 4000870 708958

**708.95 new**

Satin/Chrom Glas/Metall  
Satiné/Chrome Verre/  
Métal  
Satijn/Chroom Glas/Metaal

### 4 Verve

max. 20 W, E27  
230 V  
176 cm ø200 mm  
EAN 4000870 708903

**708.90 new**

Grau/Chrom Beton/  
Metall  
Gris/Chrome Béton/  
Métal  
Grijs/Chroom Beton/Metaal

### 5 Cameo

max. 20 W, E27  
230 V  
180 cm ø220 mm  
EAN 4000870 708910

**708.91 new**

Schwarz/Holz Metall/  
Holz  
Noir/Bois Métal/Bois  
Zwart/Hout Metaal/Hout

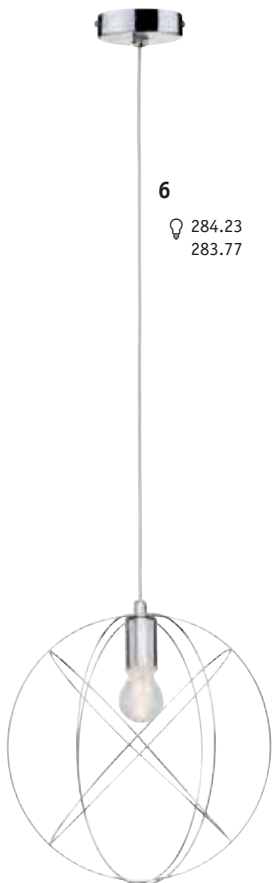

6

284.23  
283.77



7

284.23  
283.77

### 6 Galacta

max. 20 W, E27  
230 V  
188 cm ø350 mm  
EAN 4000870 708927

**708.92 new**

Chrom Metall  
Chrome Métal  
Chroom Metaal

### 7 Calma

max. 20 W, E27  
230 V  
180 cm ø290 mm  
EAN 4000870 708934

**708.93 new**

Weiß Metall  
Blanc Métal  
Wit Metaal

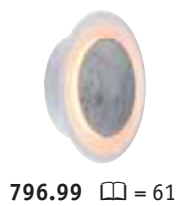



796.15 ☞ = 71



796.06 ☞ = 72



796.07 ☞ = 72



796.11 ☞ = 73



796.16 ☞ = 75



796.18 ☞ = 75



503.32 ☞ = 76



796.21 ☞ = 76



796.63 ☞ = 76



796.17 ☞ = 77



796.25 ☞ = 78



796.22 ☞ = 78



796.24 ☞ = 79



796.65 ☞ = 79



796.27 ☞ = 79



796.95 ☞ = 81

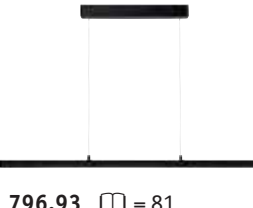

796.93 ☞ = 81



709.21 ☞ = 83



797.07 ☞ = 83



709.26 ☞ = 84

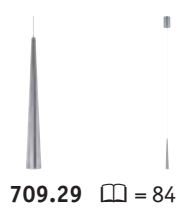

709.29 ☞ = 84



796.96 ☞ = 85

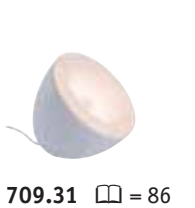

709.31 ☞ = 86



795.34 ☞ = 87



797.35 ☞ = 88



709.28 ☞ = 88



709.25 ☞ = 88



709.24 ☞ = 90



709.23 ☞ = 90



797.29 ☞ = 91



797.30 ☞ = 92



797.32 ☞ = 92



770.32 ☞ = 93



702.45 ☞ = 94



770.29 ☞ = 94



# Neordic

## Neordic Wohnraumleuchten – neu, nordisch, natürlich

Die Pendel, Steh-, Tisch- und Wand-/Deckenleuchten der Neordic-Serie liegen voll im Trend des skandinavisch inspirierten Designs.

Schlichte Eleganz, natürliche Materialien und angenehme Farbkombinationen bereichern das heimische Ambiente, setzen nordische Akzente und zugleich warme Akzente.

Natürlicher Kork in Kombination mit Schwarz und gebürstetem Messing passt perfekt zum Megatrend „Urban Jungle“.

Echtes Holz, warm durchleuchtet, trifft auf Kupfer und Beton, aber schafft auch mit Gold und Softgrün eine harmonische Allianz. Schwarzer oder weißer Marmor mit Gold und Glas, mattschwarzes Metall und helles Textil oder schlichter Beton mit edler Metallfassung – so vielseitig sind die modernen Neordic Stilwelten. Und mit der großen Auswahl der dekorativen Paulmann LED-Leuchtmittel lassen sich die Neordic-Leuchten perfekt bestücken.

## Éclairages domestiques Neordic – nouveau, nordique, naturel

Les suspensions, lampes à poser, appliques et plafonniers de la nouvelle collection Neordic surfent parfaitement sur la tendance du design d'inspiration scandinave.

Distillant des touches nordiques et chaudes à la fois, leur élégance sobre, la noblesse de leurs matériaux et leurs combinaisons de couleurs harmonieuses subliment l'ambiance de votre intérieur.

Liège naturel combiné au noir et au laiton brossé, idéal pour la mégatendance « Urban Jungle ».

Associé au cuivre et au béton, le bois véritable baigné d'une lumière chaude s'allie lui aussi harmonieusement avec le doré et le vert satiné. Marbre noir ou blanc avec doré et verre métal noir mat et textile clair, ou béton sobre avec une douille élégante en métal : les univers de style modernes proposés par Neordic sont aussi variés que cela ! Et la vaste collection des ampoules LED décoratives Paulmann permet d'équiper parfaitement les luminaires Neordic.

## Neordic-woonkamerlampen – nieuw, Scandinavisch, natuurlijk

De hang-, staande, tafel- en muur-/plafondlampen van de nieuwe Neordic-serie passen volledig in de trend van Scandinavisch geïnspireerd design.

Sobere elegantie, natuurlijke materialen en aangename kleurcombinaties verrijken de huiselijke sfeer, zetten Scandinavische en tegelijk warme accenten.

Natuurlijke kurk gecombineerd met zwarte en geborstelde messing past perfect bij de megatrend „Urban Jungle“.

Echt hout, warm verlicht, wordt gecombineerd met koper en beton of vormt ook met goud en soft groen een harmonische alliantie. Zwart of wit marmer met goud en glas, matzwart metaal en licht textiel of sober beton met een hoogwaardige metalen fitting – zo veelzijdig zijn de moderne Neordic-stijlwerelden. En met de grote keuze aan decoratieve Paulmann-LED-lichtbronnen kunnen de Neordic-armaturen perfect worden uitgerust.



Echter Beton  
Béton véritable  
Echt beton

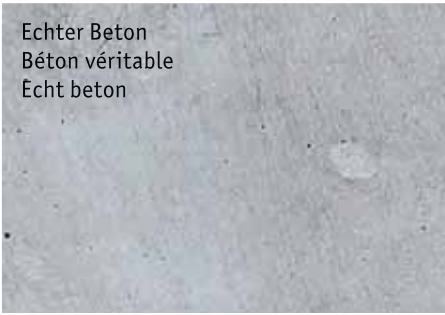

Echtholz  
Bois véritable  
Echt hout

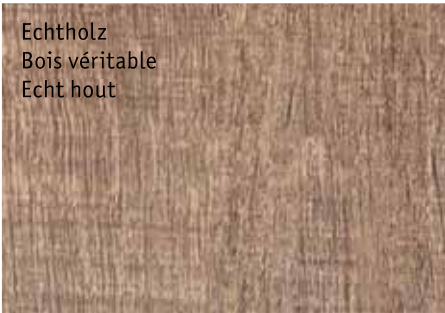

Echter Marmor  
Marbre véritable  
Echt marmer

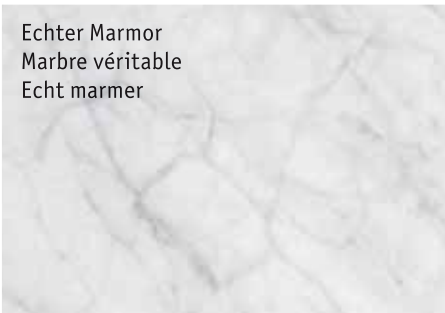

Echter Kork  
Liège véritable  
Echt kurk

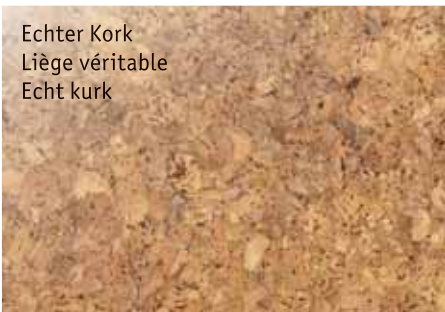

Textilkabel  
Câble en textile  
Textielkabel



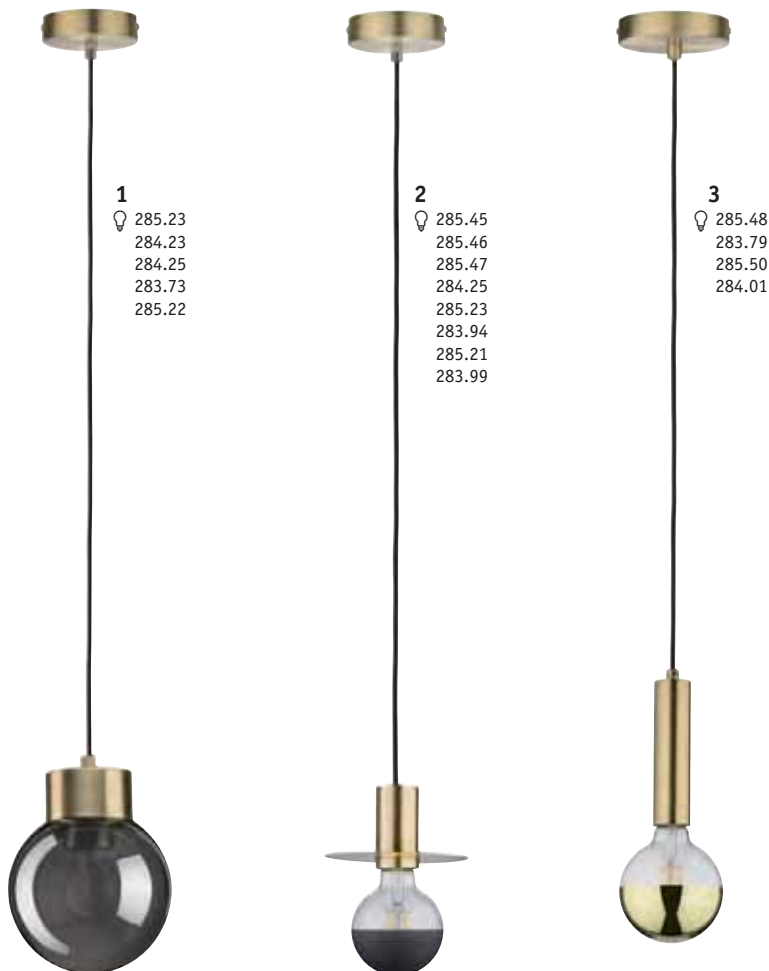

**1**  
 285.23  
 284.23  
 284.25  
 283.73  
 285.22

**2**  
 285.45  
 285.46  
 285.47  
 284.25  
 285.23  
 283.94  
 285.21  
 283.99

**3**  
 285.48  
 283.79  
 285.50  
 284.01

**1 Linja** A++-E  
 max. 20 W, E27  
 230 V  
 ⚡150 cm ø165 mm  
 EAN 4000870 797433  
**797.43 new**

☞ Rauchglas/Messing gebürstet  
 ☞ Spiegel/Glas/Metall  
 ☞ Verre fumé/Laiton brossé  
 ☞ Miroir/Verre/Métal  
 ☞ Rookglas/Messing geborsteld  
 ☞ Spiegel/Glas/Metaal

**2 Stian** A++-E  
 max. 20 W, E27  
 220-240 V  
 ⚡161 cm ø150 mm  
 EAN 4000870 797266  
**797.26 new**

☞ Messing gebürstet ☞ Metall  
 ☞ Laiton brossé ☞ Métal  
 ☞ Messing geborsteld ☞ Metaal

**3 Kine** A++-E  
 max. 20 W, E27  
 230 V  
 ⚡143 cm ø100 mm  
 EAN 4000870 797372  
**797.37 new**

☞ Messing gebürstet ☞ Metall  
 ☞ Laiton brossé ☞ Métal  
 ☞ Messing geborsteld ☞ Metaal



285.45  
 285.46  
 285.48  
 285.50  
 283.79  
 283.99

**Dilja** A++-E  
 max. 20 W, E27  
 230 V  
 ⚡85 ↔85 ⚡85 mm  
 EAN 4000870 797280  
**797.28 new**

☞ Messing gebürstet  
 ☞ Metall  
 ☞ Laiton brossé ☞ Métal  
 ☞ Messing geborsteld ☞ Metaal



285.48  
 283.79

**Vala** A++-E  
 max. 20 W, E27  
 230 V  
 ⚡120 ø110 mm  
 EAN 4000870 797426  
**797.42 new**

☞ Messing gebürstet/Marmor  
 ☞ Metall/Marmor  
 ☞ Laiton brossé/Marbre ☞ Métal/  
 Marbre  
 ☞ Messing geborsteld/Marmer  
 ☞ Metaal/Marmer



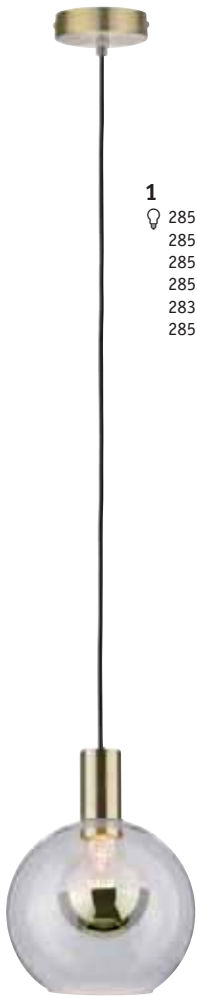

1  
 285.45  
 285.46  
 285.47  
 285.21  
 283.99  
 285.23



2  
 283.31  
 283.32  
 284.69



285.45  
 285.46  
 285.47  
 285.21  
 283.99  
 285.23

**Esben**

max. 20 W, E27  
 220-240 V  
 ⚙️218 ↔250 ⚙️200 mm  
 EAN 4000870 797273

**797.27 new**

🔩 Klar/Messing gebürstet  
 🏠 Glas/Metall  
 🔩 Clair/Laiton brossé 🏠 Verre/Métal  
 🔩 Helder/Messing geborsteld  
 🏠 Glas/Metaal



**1 Esben**

max. 20 W, E27  
 220-240 V  
 ⚙️178 cm ⌀200 mm  
 EAN 4000870 797259  
**797.25 new**

🔩 Klar/Messing gebürstet 🏠 Glas/Metall  
 🔩 Clair/Laiton brossé 🏠 Verre/Métal  
 🔩 Helder/Messing geborsteld  
 🏠 Glas/Metaal



**2 Menja**

max. 20 W, E27  
 230 V  
 ⚙️173 cm ⌀200 mm  
 EAN 4000870 797334  
**797.33 new**

🔩 Weiß/Messing gebürstet  
 🏠 Glas/Metall  
 🔩 Blanc/Laiton brossé 🏠 Verre/Métal  
 🔩 Wit/Messing geborsteld  
 🏠 Glas/Metaal



283.78  
 283.77  
 283.32  
 283.31

**Olar**

max. 20 W, E27  
 230 V  
 ⚙️510 ⌀250 mm  
 EAN 4000870 797310

**797.31 new**

🔩 Blau/Weiß/Messing gebürstet  
 🏠 Stoff/Marmor/Metall  
 🔩 Bleu/Blanc/Laiton brossé  
 🏠 Tissus/Marbre/Métal  
 🔩 Blauw/Wit/Messing geborsteld  
 🏠 Textiel/Marmer/Metaal





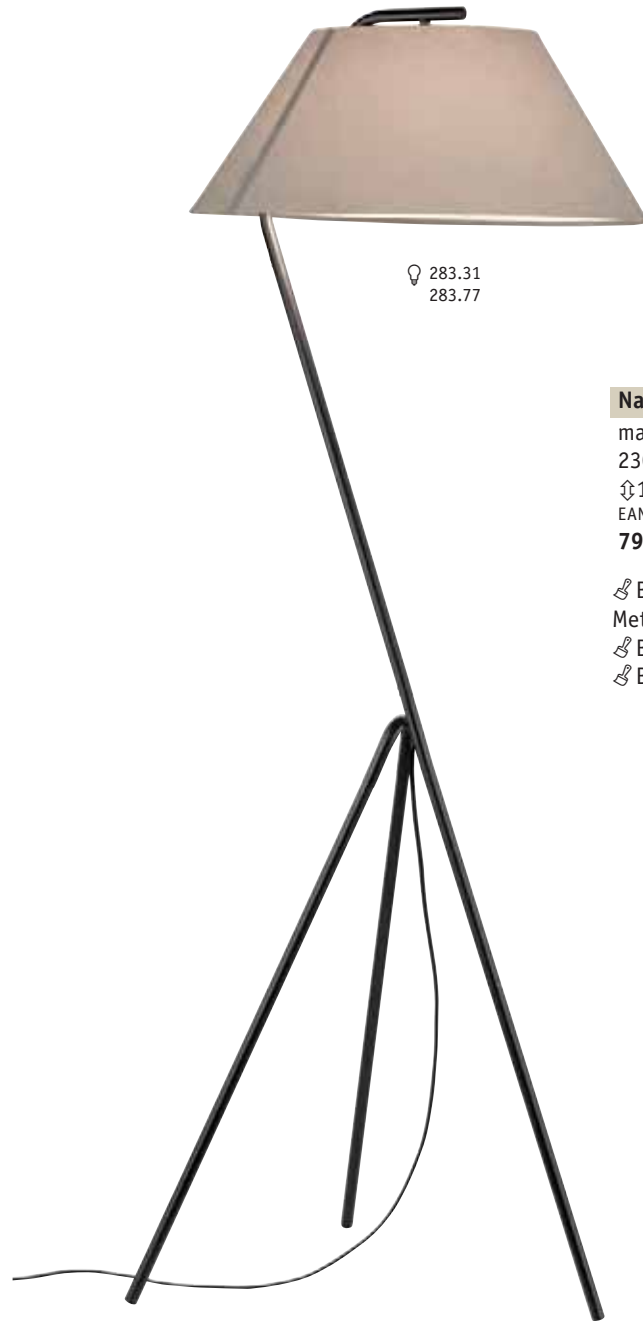

283.31  
283.77

**Narve**

A++-E

max. 60 W, E27  
230 V

↑1.540 ↔525 ↗535 mm

EAN 4000870 797242

**797.24 new**



🔗 Beige/Schwarz 📦 Stoff/  
Metall

🔗 Beige/Noir 📦 Tissus/Métal

🔗 Beige/Zwart 📦 Textiel/Metaal



283.85

**Narve**

A++-E

max. 60 W, E27  
230 V

↑480 ø397 mm

EAN 4000870 797235

**797.23 new**



🔗 Beige/Schwarz 📦 Stoff/  
Metall

🔗 Beige/Noir 📦 Tissus/Métal

🔗 Beige/Zwart 📦 Textiel/Metaal



Real cork/Smoke glass



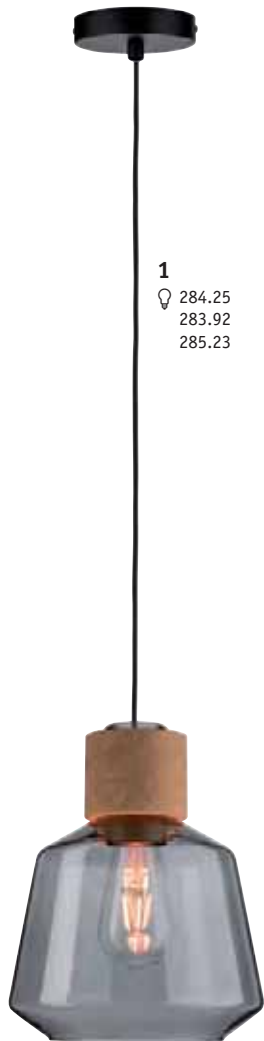

1  
 284.25  
 283.92  
 285.23



2  
 284.25  
 283.92  
 285.23



3  
 283.74  
 283.92



4  
 285.49  
 285.50  
 283.79  
 284.01



5  
 285.46  
 285.45  
 285.47  
 285.48  
 285.50  
 285.49  
 283.79  
 284.01

**1 Elia** A++-E  
 max. 20 W, E27  
 230 V  
 ⚡ 150 cm ø208 mm  
 EAN 4000870 797396  
**797.39 new**

☞ Rauchglas/Kork/Schwarz  
 ☞ Glas/Kork/Metall  
 ☞ Verre fumé/Liège/Noir ☞ Verre/Liège/Métal  
 ☞ Rookglas/Kurk/Zwart ☞ Glas/Kurk/Metaal

**2 Edla** A++-E  
 max. 20 W, E27  
 230 V  
 ⚡ 150 cm ø180 mm  
 EAN 4000870 797402  
**797.40 new**

☞ Rauchglas/Kork/Schwarz  
 ☞ Glas/Kork/Metall  
 ☞ Verre fumé/Liège/Noir ☞ Verre/Liège/Métal  
 ☞ Rookglas/Kurk/Zwart ☞ Glas/Kurk/Metaal

**3 Iben** A++-E  
 max. 20 W, E27  
 230 V  
 ⚡ 255 ø190 mm  
 EAN 4000870 797365  
**797.36 new**

☞ Rauchglas ☞ Glas/Kork  
 ☞ Verre fumé ☞ Verre/Liège  
 ☞ Rookglas ☞ Glas/Kurk

**4 Eske** A++-E  
 max. 20 W, E27  
 230 V  
 ⚡ 145 ø160 mm  
 EAN 4000870 797389  
**797.38 new**

☞ Schwarz ☞ Kork/Metall  
 ☞ Noir ☞ Liège/Métal  
 ☞ Zwart ☞ Kurk/Metaal

**5 Tona** A++-E  
 max. 20 W, E27  
 230 V  
 ⚡ 130 ø80 mm  
 EAN 4000870 797419  
**797.41 new**

☞ Kork ☞ Kork  
 ☞ Liège ☞ Liège  
 ☞ Kurk ☞ Kurk



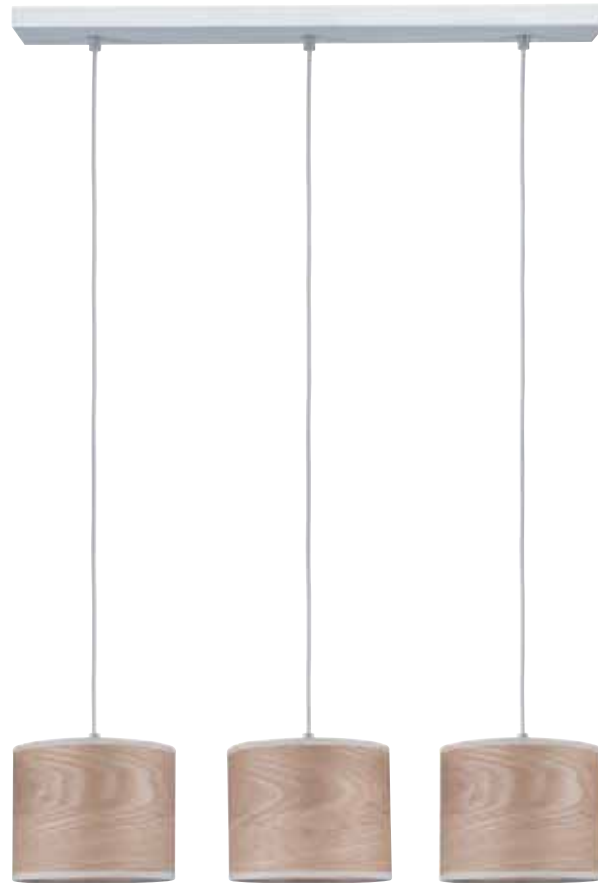

2

- 283.31
- 283.32
- 283.73
- 283.74
- 283.77
- 283.78
- 284.23
- 284.81



3

- 283.31
- 283.32
- 283.73
- 283.74
- 283.77
- 283.78

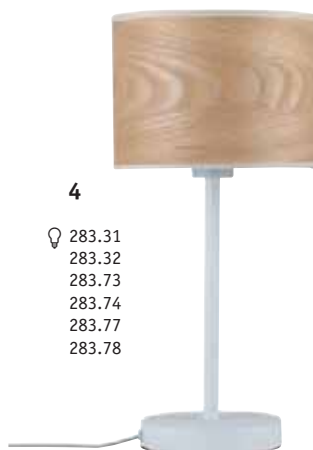

4

- 283.31
- 283.32
- 283.73
- 283.74
- 283.77
- 283.78



5

- 282.92
- 283.15
- 283.27
- 283.63

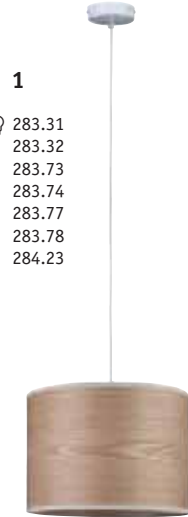

1

- 283.31
- 283.32
- 283.73
- 283.74
- 283.77
- 283.78
- 284.23

**1 Neta** A++-E

max. 20 W, E27  
230 V  
148 cm ø380 mm  
EAN 4000870 796306  
**796.30**



**2 Neta** A++-E

max. 3×20 W, E27  
230 V  
139 cm ↔600 mm  
100 mm  
EAN 4000870 796412  
**796.41**



**3 Neta** A++-E

max. 20 W, E27  
230 V  
1.510 ø350 mm  
EAN 4000870 796375  
**796.37**



**4 Neta** A++-E

max. 20 W, E27  
230 V  
445 ø220 mm  
EAN 4000870 796382  
**796.38**



🪵 Holz/Weiß 🧱 Holz/Metall  
🪵 Bois/Blanc 🧱 Bois/Métal  
🪵 Hout/Wit 🧱 Hout/Metaal

**5 Skadi** A++-E

max. 20 W, E14  
230 V  
350 ø110 mm  
EAN 4000870 796641  
**796.64**



🪵 Holz/Grau 🧱 Holz/Beton  
🪵 Bois/Gris 🧱 Bois/Béton  
🪵 Hout/Grijs 🧱 Hout/Beton



1

💡 283.31  
283.32  
283.77  
283.78

2

💡 283.33  
283.78  
283.85



**1 Stellan** A++-E

max. 20 W, E27  
230 V  
📏 1.615 ø350 mm  
EAN 4000870 796344  
**796.34**



**2 Stellan** A++-E

max. 20 W, E27  
230 V  
📏 400 ø155 mm  
EAN 4000870 796368  
**796.36**



🕯️ Weiß/Holz 🗪 Stoff/Metall/Holz  
🕯️ Blanc/Bois 🗪 Tissus/Métal/Bois  
🕯️ Wit/Hout 🗪 Textiel/Metaal/Hout





283.79  
283.87  
283.88  
283.93  
283.94  
284.57

**1 Talin**

max. 20 W, E27  
230 V  
∅130 ∅90 mm  
EAN 4000870 796405  
**796.40**

Holz Holz  
Bois Bois  
Hout Hout



283.79  
283.87  
283.88  
283.93  
283.94  
284.57

**3**



283.33  
283.85

**2 Berit**

max. 20 W, E27  
230 V  
∅315 ∅220 mm  
EAN 4000870 796467  
**796.46**

Weiß/Holz Stoff/Holz/  
Metall  
Blanc/Bois Tissus/Bois/Métal  
Wit/Hout Textiel/Hout/  
Metaal



**4**

283.31  
283.32  
283.77  
283.78

**3 Talin**

max. 20 W, E27  
230 V  
∅190 cm ∅100 mm  
EAN 4000870 796986  
**796.98 new**

Holz/Eisen gebürstet Holz/  
Metall  
Bois/Acier brossé Bois/Métal  
Hout/Staal geborsteld Hout/  
Metaal



**4 Rurik**

max. 20 W, E27  
230 V  
∅1.530 ∅538 mm  
EAN 4000870 796337  
**796.33**

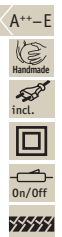

**5 Rurik**

max. 20 W, E27  
230 V  
∅700 ∅250 mm  
EAN 4000870 796351  
**796.35**



Grau/Holz Stoff/Metall/Holz  
Gris/Bois Tissus/Métal/Bois  
Grijs/Hout Textiel/Metaal/  
Hout

**5**

283.31  
283.32  
283.77  
283.78





**1**  
 282.98  
 283.31  
 283.32  
 283.49  
 284.23



**1 Liska** A++-E  
 max. 3×20 W, E27  
 230 V  
 ⚡150 ø450 mm  
 EAN 4000870 796870  
**796.87**

🪵 Holz dunkel 🧱 Holz/Metall  
 🪵 Bois foncé 🧱 Bois/Métal  
 🪵 Hout donker 🧱 Hout/Metaal

**2**  
 282.98  
 283.31  
 283.32  
 283.49  
 284.23

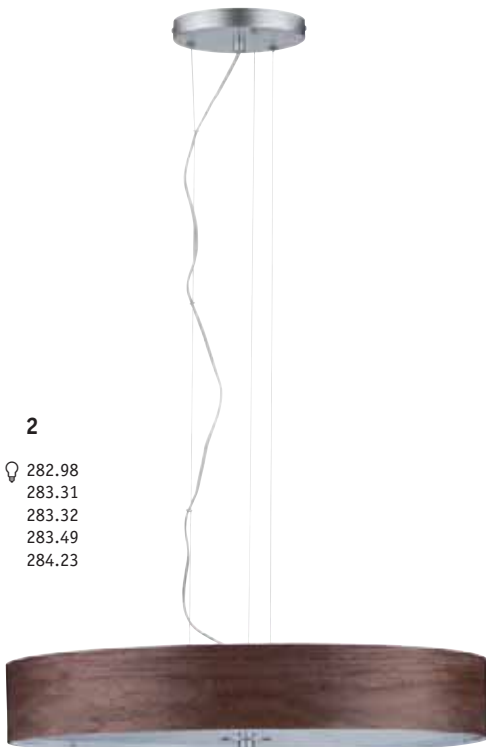

**3**  
 282.98  
 283.31  
 283.32  
 283.78

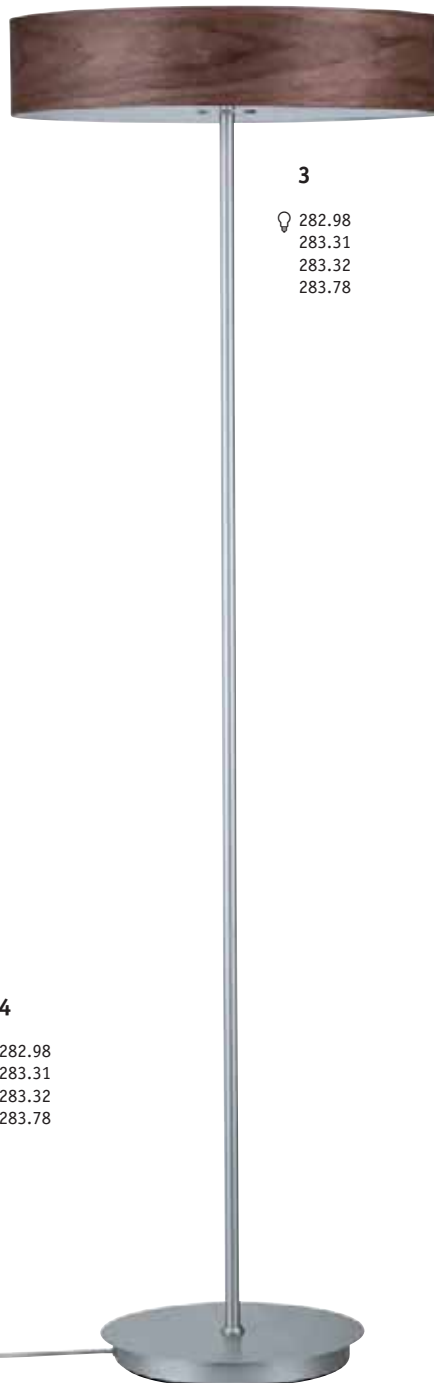

**2 Liska** A++-E  
 max. 3×20 W, E27  
 230 V  
 ⚡132 cm ø600 mm  
 EAN 4000870 796863  
**796.86**

**3 Liska** A++-E  
 max. 3×20 W, E27  
 230 V  
 ⚡1.420 ø450 mm  
 EAN 4000870 796856  
**796.85**

**4 Liska** A++-E  
 max. 2×20 W, E27  
 230 V  
 ⚡400 ø320 mm  
 EAN 4000870 796849  
**796.84**

🪵 Holz dunkel/Chrom matt  
 🧱 Holz/Metall  
 🪵 Bois foncé/Chrome mat 🧱 Bois/Métal  
 🪵 Hout donker/Chroom mat  
 🧱 Hout/Metaal

**4**  
 282.98  
 283.31  
 283.32  
 283.78





Transparentes Kabel mit Kupferlitze  
Câble transparent avec fils en cuivre  
Transparante kabel met koperdraad

**1**  
282.98  
283.31  
283.32  
283.49  
284.23



**1 Liska** A++-E  
max. 3×20 W, E27  
230 V  
⌈150 ⌀450 mm  
EAN 4000870 796504  
**796.50**

🔗 Holz 🗺 Holz/Metall  
🔗 Bois 🗺 Bois/Métal  
🔗 Hout 🗺 Hout/Metaal

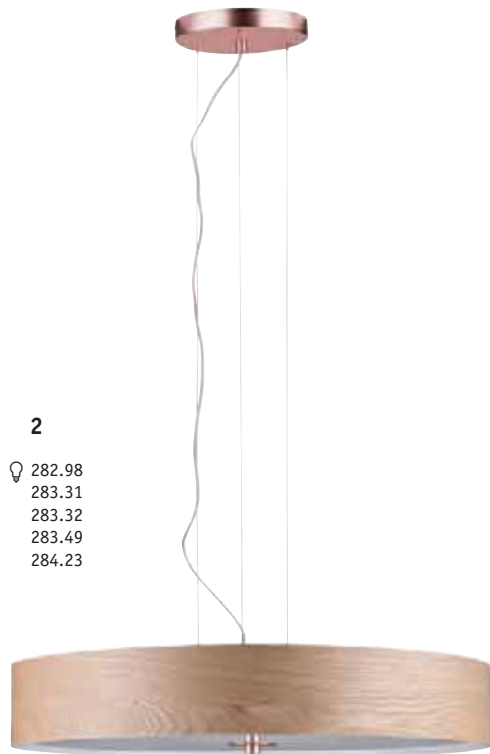

**2**  
282.98  
283.31  
283.32  
283.49  
284.23

**3**  
282.98  
283.31  
283.32  
283.78



**2 Liska** A++-E  
max. 3×20 W, E27  
230 V  
⌈132 cm ⌀600 mm  
EAN 4000870 796498  
**796.49**

**3 Liska** A++-E  
max. 3×20 W, E27  
230 V  
⌈1.420 ⌀450 mm  
EAN 4000870 796481  
**796.48**

**4 Liska** A++-E  
max. 2×20 W, E27  
230 V  
⌈400 ⌀320 mm  
EAN 4000870 796474  
**796.47**

🔗 Holz/Kupfer matt 🗺 Holz/Metall  
🔗 Bois/Cuivre Dépoli 🗺 Bois/Métal  
🔗 Hout/Koper mat 🗺 Hout/Metaal



**4**  
282.98  
283.31  
283.32  
283.78



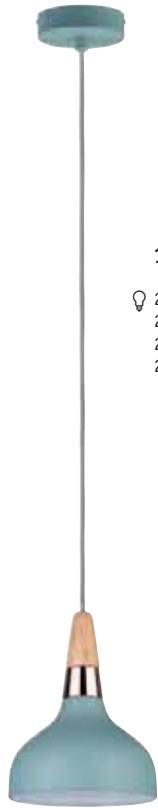

**1**  
 283.70  
 284.41  
 284.55  
 285.01



**2**  
 283.70  
 284.41  
 284.55  
 285.01

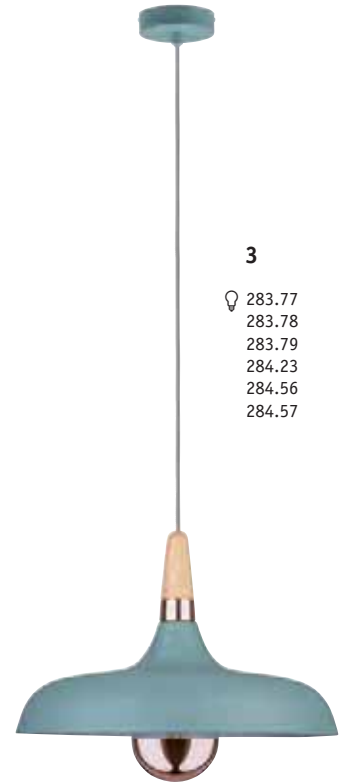

**3**  
 283.77  
 283.78  
 283.79  
 284.23  
 284.56  
 284.57

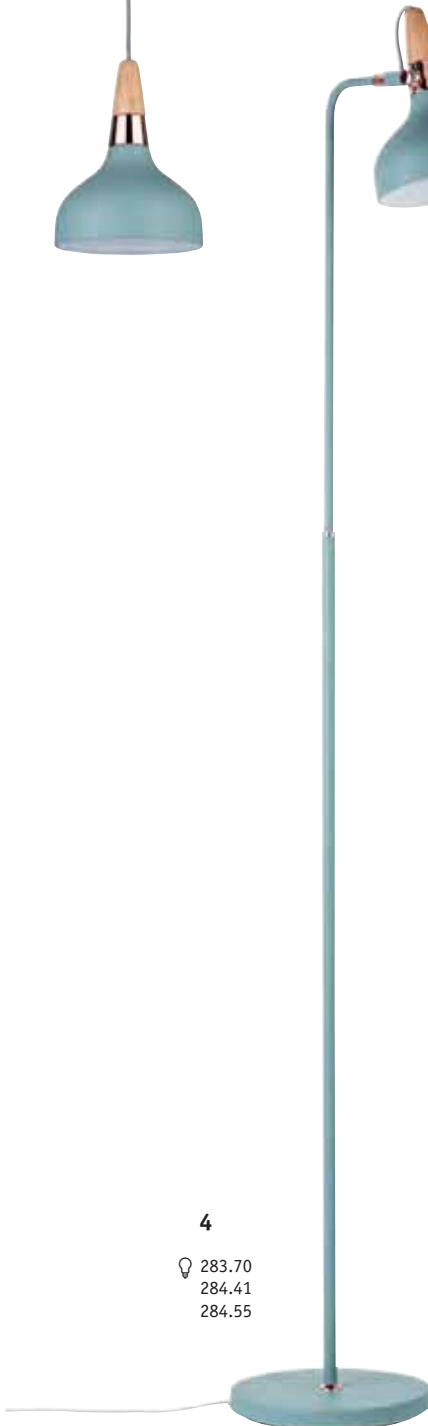

**4**  
 283.70  
 284.41  
 284.55



**5**  
 283.70  
 284.41  
 284.55

- 1 Juna** A++-E

max. 20 W, E14  
 230 V  
 ⚙ 172,5 cm ø160 mm  
 EAN 4000870 796528  
**796.52**
- 2 Juna** A++-E

max. 3×20 W, E14  
 230 V  
 ⚙ 170 cm ø460 mm  
 EAN 4000870 796535  
**796.53**
- 3 Juna** A++-E

max. 20 W, E27  
 230 V  
 ⚙ 145,5 cm ø342 mm  
 EAN 4000870 796559  
**796.55**
- 4 Juna** A++-E

max. 20 W, E14  
 230 V  
 ⚙ 1.580 ⇄ 230 ↻ 400 mm  
 EAN 4000870 796542  
**796.54**
- 5 Juna** A++-E

max. 20 W, E14  
 230 V  
 ⚙ 510 ⇄ 180 ↻ 255 mm  
 EAN 4000870 796511  
**796.51**

Softgrün/Kupfer/Holz Metall/  
 Holz  
 Vert satiné/Cuivre/Bois  
 Métal/Bois  
 Softgroen/Koper/Hout  
 Metaal/Hout





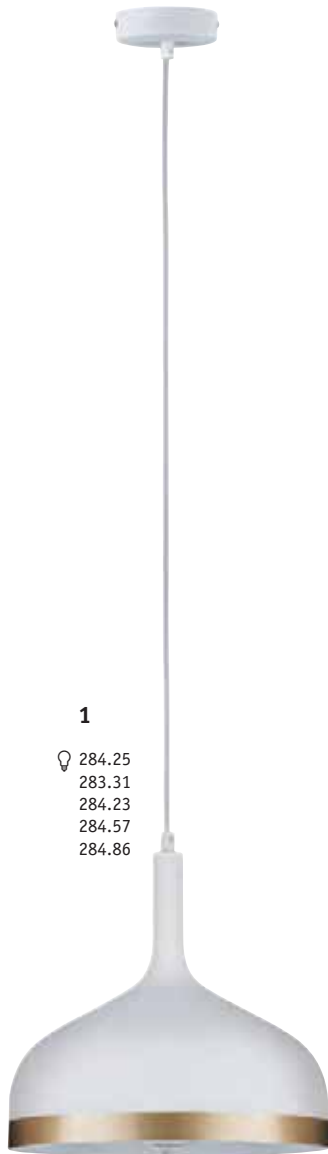

**1**  
 284.25  
 283.31  
 284.23  
 284.57  
 284.86

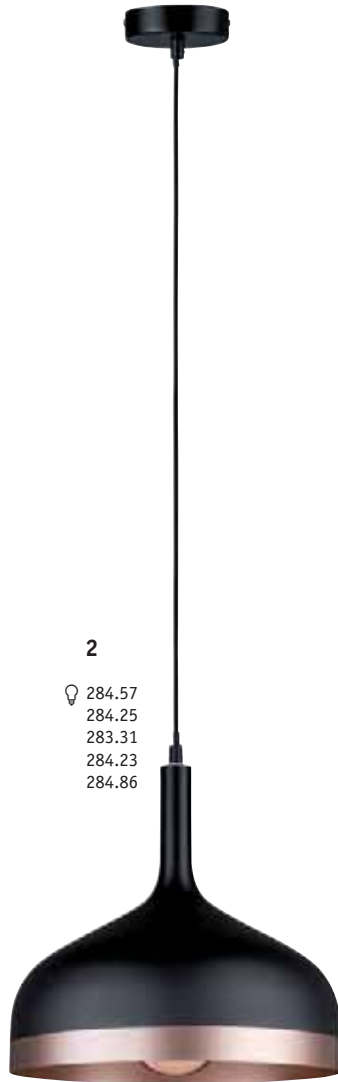

**2**  
 284.57  
 284.25  
 283.31  
 284.23  
 284.86

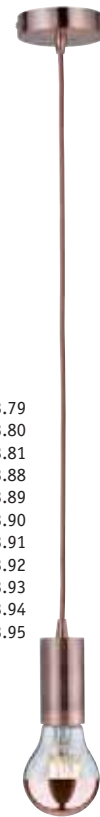

**3**  
 283.79  
 283.80  
 283.81  
 283.88  
 283.89  
 283.90  
 283.91  
 283.92  
 283.93  
 283.94  
 283.95



**Tiril** A++-A  
 incl. 1x6,5 W LED  
 780 lm, 2.700 K ☐  
 230 V  
 ⚡51 ø170 mm  
 EAN 4000870 796993  
**796.99 new**

☞ Weiß/Beton/Kupfer ☐ Metall/  
 Kunststoff  
 ☞ Blanc/Béton/Cuivre ☐ Métal/  
 Matière plastique  
 ☞ Wit/Beton/Koper ☐ Metaal/  
 Kunststof

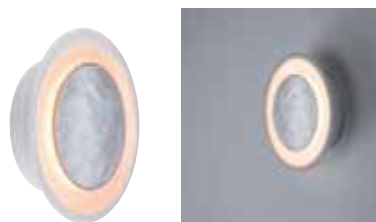

**Tiril** A++-A  
 incl. 1x6,5 W LED  
 780 lm, 2.700 K ☐  
 230 V  
 ⚡51 ø170 mm  
 EAN 4000870 797006  
**797.00 new**

☞ Weiß/Marmor/Kupfer ☐ Metall/  
 Kunststoff  
 ☞ Blanc/Marbre/Cuivre ☐ Métal/  
 Matière plastique  
 ☞ Wit/Marmer/Koper ☐ Metaal/  
 Kunststof

**1 Embla** A++-E  
 max. 20 W, E27 ☐  
 230 V ☐  
 ⚡150 cm ø300 mm ☐  
 EAN 4000870 796283 ☐  
**796.28**  
 ☞ Weiß matt/Gold ☐ Metall  
 ☞ Blanc dépoli/Doré ☐ Métal  
 ☞ Wit mat/Goud ☐ Metaal

**2 Embla** A++-E  
 max. 20 W, E27 ☐  
 ↙ 103° ☐  
 230 V ☐  
 ⚡150 cm ø300 mm ☐  
 EAN 4000870 796290 ☐  
**796.29**  
 ☞ Schwarz/Kupfer matt ☐ Metall  
 ☞ Noir/Cuivre Dépoli ☐ Métal  
 ☞ Zwart/Koper mat ☐ Metaal

**3 Pendulum** A++-E  
 max. 60 W, E27 ☐  
 230 V ☐  
 ⚡212 cm ø100 mm ↔2 m ☐  
 EAN 4000870 503287 ☐  
**503.28**  
 ☞ Kupfer ☐ Metall/  
 Kunststoff  
 ☞ Cuivre ☐ Métal/  
 Matière plastique  
 ☞ Koper ☐ Metaal/  
 Kunststof



**1**  
 283.70  
 284.41  
 284.55  
 285.01

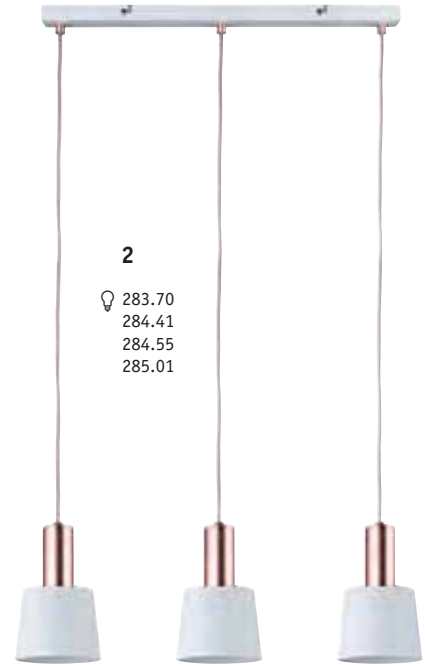

**2**  
 283.70  
 284.41  
 284.55  
 285.01



**3**  
 283.70  
 284.41  
 284.55



**4**  
 283.70  
 284.41  
 284.55



**5**  
 283.70  
 284.41  
 284.55

**1 Haldar** A++-E  
 max. 20 W, E14  
 230 V  
 ⚙️ 172 cm ø120 mm  
 EAN 4000870 796566  
**796.56**

**2 Haldar** A++-E  
 max. 3×20 W, E14  
 230 V  
 ⚙️ 142 cm ø120 mm ↔ 550 mm  
 EAN 4000870 796573  
**796.57**

**3 Haldar** A++-E  
 max. 2×20 W, E14  
 230 V  
 ⚙️ 1.520 ↔ 300 ↻ 230 mm  
 EAN 4000870 796603  
**796.60**

**4 Haldar** A++-E  
 max. 20 W, E14  
 230 V  
 ⚙️ 1.520 ø230 mm  
 EAN 4000870 796597  
**796.59**

**5 Haldar** A++-E  
 max. 20 W, E14  
 230 V  
 ⚙️ 460 ø160 mm  
 EAN 4000870 796580  
**796.58**

💡 Weiß/Kupfer matt   Metall  
 💡 Blanc/Cuivre Dépouli   Métal  
 💡 Wit/Koper mat   Metaal





1

💡 283.69  
283.70  
284.41  
285.01  
285.04

**1 Haldar** A++-E  
max. 20 W, E14  
230 V  
📏 172 cm ø120 mm  
EAN 4000870 796917  
**796.91**

**2 Haldar** A++-E  
max. 2×20 W, E14  
230 V  
📏 1.520 ⇄ 300 ⇄ 230 mm  
EAN 4000870 796900  
**796.90**

**3 Haldar** A++-E  
max. 20 W, E14  
230 V  
📏 1.520 ø230 mm  
EAN 4000870 796924  
**796.92**

**4 Haldar** A++-E  
max. 20 W, E14  
230 V  
📏 460 ø160 mm  
EAN 4000870 796894  
**796.89**

👉 Dunkelgrau/Chrom matt  
👉 Metall  
👉 Gris foncé/Chrome mat  
👉 Donkergrijs/Chroom mat  
👉 Metaal



2

💡 283.69  
283.70  
284.41



3

💡 283.69  
283.70  
284.41



4

💡 283.69  
283.70  
284.41



**1 Thala**

A++-E

max. 20 W, E14  
230V  
⇅640 ø200 mm  
EAN 4000870 796832  
**796.83**



🔧 Grau 📦 Metall  
🔧 Gris 📦 Métal  
🔧 Grijs 📦 Metaal

**2 Thala**

A++-E

max. 20 W, E14  
230V  
⇅1.410 ø300 mm  
EAN 4000870 796825  
**796.82**



🔧 Grau 📦 Metall  
🔧 Gris 📦 Métal  
🔧 Grijs 📦 Metaal



**1**

💡 283.70  
284.41

**2**

💡 283.70  
284.41



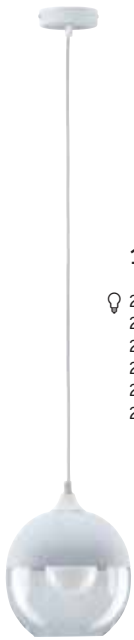

1

- 💡 282.10
- 283.31
- 283.32
- 284.56
- 284.81
- 284.86



2

- 💡 284.36

**1 Vanja** A++-E

max. 20W, E27  
230V  
⬆️145 cm ⌀200 mm  
EAN 4000870 796443  
**796.44**



**2 Vanja** A++-E

max. 3×20W, E27  
230V  
⬆️155 cm ⇔600 mm ↗️100 mm  
EAN 4000870 796436  
**796.43**

- 👉 Weiß matt/Klar 🗍 Glas/Metall
- 👉 Blanc dépoli/Clair 🗍 Verre/Métal
- 👉 Wit mat/Helder 🗍 Glas/Metaal



3

- 💡 284.36



4

- 💡 282.10
- 283.31
- 283.32
- 283.75
- 284.81
- 284.86

**3 Vanja** A++-E

max. 3×20W, E27  
230V  
⬆️155 cm ⇔600 mm ↗️100 mm  
EAN 4000870 796429  
**796.42**

**4 Vanja** A++-E

max. 20W, E27  
230V  
⬆️145 cm ⌀200 mm  
EAN 4000870 796450  
**796.45**

- 👉 Grau/Klar 🗍 Glas/Metall
- 👉 Gris/Clair 🗍 Verre/Métal
- 👉 Grijs/Helder 🗍 Glas/Metaal





1

283.79  
283.80  
283.81  
283.88  
283.89  
283.90  
283.91  
283.92  
283.93  
283.94  
283.95

2

283.79  
283.80  
283.81  
283.88  
283.89  
283.90  
283.91  
283.92  
283.93  
283.94  
283.95

3

283.76  
283.79  
283.87  
284.23  
284.56  
284.57  
284.25

4

283.76  
283.79  
283.87  
284.23  
284.56  
284.57  
284.25

1 **Pendulum**

max. 60 W, E27  
230 V  
∅210 cm ∅100 mm  
EAN 4000870 503232  
**503.23**

Rot/Nickel gebürstet Metall  
Rouge/Nickel brossé Métal  
Rood/Nikkel geborsteld  
Metaal

2 **Pendulum**

max. 60 W, E27  
230 V  
∅210 cm ∅100 mm  
EAN 4000870 503225  
**503.22**

Grau/Nickel gebürstet Metall  
Gris/Nickel brossé Métal  
Grijs/Nikkel geborsteld  
Metaal

3 **Pendulum**

max. 20 W, E27  
230 V  
∅100 mm ∅217 cm ∅45 mm  
EAN 4000870 503423  
**503.42 new**

Schwarz Silikon  
Noir Silicone  
Zwart Silicon

4 **Pendulum**

max. 3×20 W, E27  
230 V  
∅100 mm ∅212 cm ∅45 mm  
EAN 4000870 503430  
**503.43 new**

Schwarz Silikon/Metall  
Noir Silicone/Métal  
Zwart Silicon/Metaal



5 **Canopy**

max. 60 W, E27  
230 V  
∅28 ∅200 mm  
EAN 4000870 503416  
**503.41**

Weiß Metall  
Blanc Métal  
Wit Metaal



Real marble





**1**  
 284.23  
 283.31  
 283.32  
 283.78  
 283.77

**2**  
 284.23  
 283.31  
 283.32

**3**  
 283.78  
 283.77  
 283.31  
 283.32

**4**  
 283.38

**5**  
 283.38

- 1 Roald** A++-E

max. 20 W, E27  
 230 V  
 ⚡ 156 cm ⌀260 mm  
 EAN 4000870 796092  
**796.09**

👉 Schwarz matt/Kupfer matt  
👉 Metall/Marmor  
👉 Noir mat/Cuivre Dépoli  
👉 Métal/Marbre  
👉 Zwart mat/Koper mat 👉 Metaal/Marmer
- 2 Ivar** A++-E

max. 3×20 W, E27  
 230 V  
 ⚡ 147 cm ⇄ 600 mm ↻100 mm  
 EAN 4000870 796085  
**796.08**

👉 Schwarz matt/Kupfer matt  
👉 Metall/Marmor  
👉 Noir mat/Cuivre Dépoli  
👉 Métal/Marbre  
👉 Zwart mat/Koper mat 👉 Metaal/Marmer
- 3 Enja** A++-E

max. 20 W, E27  
 230 V  
 ⚡ 1.600 ⌀245 mm  
 EAN 4000870 796122  
**796.12**

👉 Schwarz/Kupfer 👉 Stoff/Marmor/Metall  
👉 Noir/Cuivre 👉 Tissus/Marbre/Métal  
👉 Zwart/Koper 👉 Textiel/Marmer/Metaal
- 4 Moa** A++-E

max. 10 W, G9  
 230 V  
 ⚡ 400 ⌀100 mm  
 EAN 4000870 796627  
**796.62**

👉 Weiß/Schwarz/Kupfer matt  
👉 Glas/Marmor/Metall  
👉 Blanc/Noir/Cuivre Dépoli  
👉 Verre/Marbre/Métal  
👉 Wit/Zwart/Koper mat 👉 Glas/Marmer/Metaal
- 5 Moa** A++-E

max. 10 W, G9  
 230 V  
 ⚡ 400 ⌀100 mm  
 EAN 4000870 796887  
**796.88**

👉 Weiß/Schwarz/Chrom matt  
👉 Glas/Marmor/Metall  
👉 Blanc/Noir/Chrome mat  
👉 Verre/Marbre/Métal  
👉 Wit/Zwart/Chroom mat 👉 Glas/Marmer/Metaal



1

284.57  
283.79  
283.88  
283.87  
283.94  
284.23  
284.24  
284.25



2

283.79  
284.57  
283.88  
283.87  
283.94

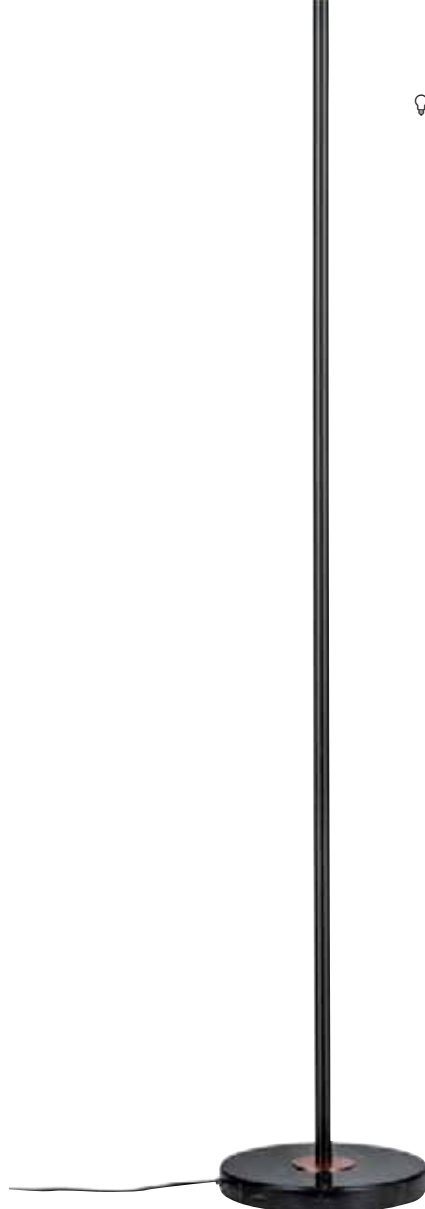

1 **Nordin**

max. 20 W, E27  
230 V  
190 cm ø100 mm  
EAN 4000870 796054  
**796.05**

Schwarz/Kupfer matt  
Marmor/Metall  
Noir/Cuivre Dépoli Marbre/Métal  
Zwart/Koper mat Marmer/Metaal



2 **Nordin**

max. 20 W, E27  
230 V  
1.200 ø200 mm  
EAN 4000870 796146  
**796.14**

Schwarz/Kupfer matt  
Marmor/Metall  
Noir/Cuivre Dépoli Marbre/Métal  
Zwart/Koper mat Marmer/Metaal



3

284.57  
283.79  
283.88  
283.87  
283.94



3 **Nordin**

max. 20 W, E27  
230 V  
130 ø95 mm  
EAN 4000870 796009  
**796.00**

Schwarz Marmor  
Noir Marbre  
Zwart Marmer







**1 Pendulum** A++-E  
 max. 60 W, E27  
 230 V  
 ⚡ 95 mm ⚡ 211 cm ⚡ 52 mm  
 EAN 4000870 503355  
**503.35**

🔗 Gold/Alabaster 📦 Metall/Kunststoff  
 🔗 Doré/Albâtre 📦 Métal/Matière plastique  
 🔗 Goud/Albast 📦 Metaal/Kunststof



**1**  
 ⚡ 283.79  
 283.80  
 283.81  
 283.88  
 283.89  
 283.90  
 283.91  
 283.92  
 283.94  
 283.95



**3**  
 ⚡ 283.79  
 283.88  
 284.57  
 283.87  
 283.94  
 284.23  
 284.24  
 284.25

**2 Nordin** A++-E  
 max. 20 W, E27  
 230 V  
 ⚡ 1.200 ⚡ 200 mm  
 EAN 4000870 796153  
**796.15**  
 🔗 Weiß/Gold matt 📦 Marmor/Metall  
 🔗 Blanc/Doré mat 📦 Marbre/Métal  
 🔗 Wit/Goud mat 📦 Marmer/Metaal



**2**  
 ⚡ 283.79  
 283.88  
 284.57  
 283.87  
 283.94

**3 Nordin** A++-E  
 max. 20 W, E27  
 230 V  
 ⚡ 190 cm ⚡ 100 mm  
 EAN 4000870 796047  
**796.04**  
 🔗 Weiß/Gold matt 📦 Marmor/Metall  
 🔗 Blanc/Doré mat 📦 Marbre/Métal  
 🔗 Wit/Goud mat 📦 Marmer/Metaal

**4**  
 ⚡ 283.79  
 283.88  
 284.57  
 283.87  
 283.94



**4 Nordin** A++-E  
 max. 20 W, E27  
 230 V  
 ⚡ 130 ⚡ 95 mm  
 EAN 4000870 796016  
**796.01**  
 🔗 Weiß 📦 Marmor  
 🔗 Blanc 📦 Marbre  
 🔗 Wit 📦 Marmer



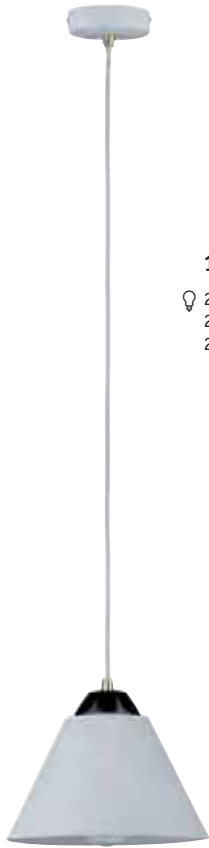

**1**  
 ⚡ 284.23  
 283.31  
 283.32

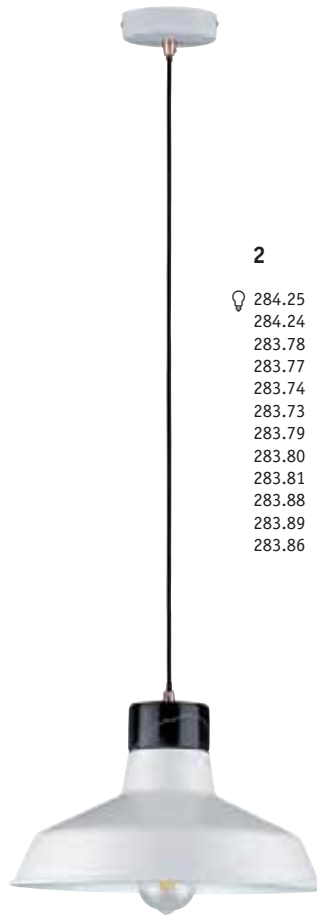

**2**  
 ⚡ 284.25  
 284.24  
 283.78  
 283.77  
 283.74  
 283.73  
 283.79  
 283.80  
 283.81  
 283.88  
 283.89  
 283.86

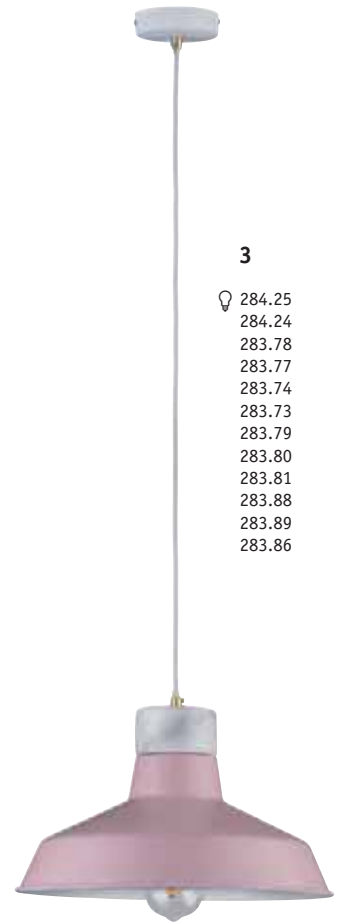

**3**  
 ⚡ 284.25  
 284.24  
 283.78  
 283.77  
 283.74  
 283.73  
 283.79  
 283.80  
 283.81  
 283.88  
 283.89  
 283.86

**1 Maiga** A++-E  
 max. 20 W, E27  
 230 V  
 ⚡ 140 cm ø230 mm  
 EAN 4000870 796061  
**796.06**

- ⚡ Weiß matt/Schwarz/Gold matt
- ⊞ Metall/Marmor
- ⚡ Blanc dépoli/Noir/Doré mat
- ⊞ Métal/Marbre
- ⚡ Wit mat/Zwart/Goud mat
- ⊞ Metaal/Marmer

**2 Disa** A++-E  
 max. 20 W, E27  
 230 V  
 ⚡ 143 cm ø350 mm  
 EAN 4000870 796078  
**796.07**

- ⚡ Weiß matt/Schwarz/  
Kupfer matt ⊞ Metall/Marmor
- ⚡ Blanc dépoli/Noir/Cuivre Dépoli
- ⊞ Métal/Marbre
- ⚡ Wit mat/Zwart/Koper mat
- ⊞ Metaal/Marmer

**3 Disa** A++-E  
 max. 20 W, E27  
 230 V  
 ⚡ 143 cm ø350 mm  
 EAN 4000870 796108  
**796.10**

- ⚡ Rosa/Weiß matt/Gold matt
- ⊞ Metall/Marmor
- ⚡ Rose/Blanc dépoli/Doré mat
- ⊞ Métal/Marbre
- ⚡ Rose/Wit mat/Goud mat
- ⊞ Metaal/Marmer

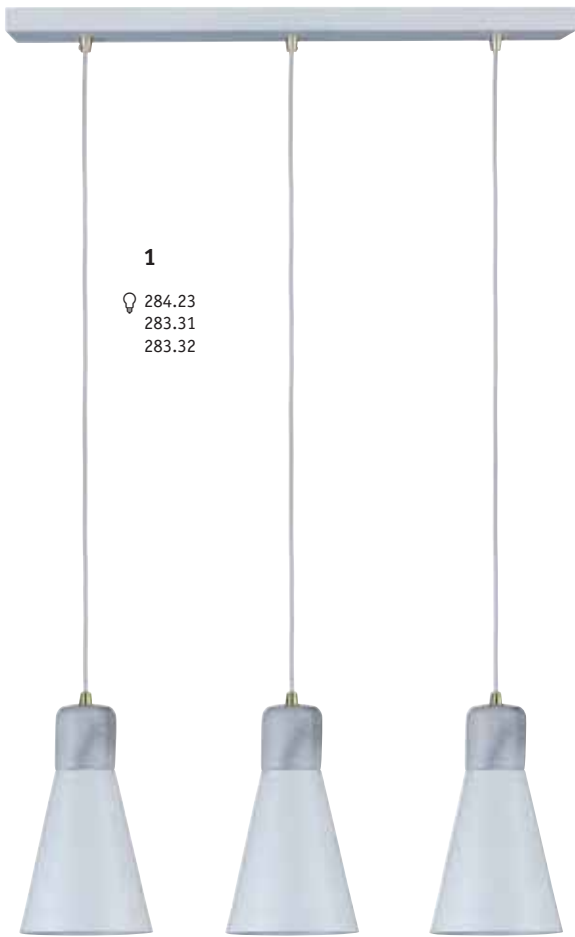

1

💡 284.23  
283.31  
283.32



3

💡 283.31  
283.32  
283.77  
283.78



2

💡 283.38

**1 Ivar** A++-E  
max. 3x20 W, E27  
230 V  
⏏ 147 cm ⏏ 600 mm ⏏ 100 mm  
EAN 4000870 796115  
**796.11**

🌀 Weiß matt/Gold matt 🧱 Metall/  
Marmor  
🌀 Blanc dépoli/Doré mat 🧱 Métal/  
Marbre  
🌀 Wit mat/Goud mat 🧱 Metaal/  
Marmer

**2 Moa** A++-E  
max. 10 W, G9  
230 V  
⏏ 400 ø100 mm  
EAN 4000870 796610  
**796.61**

🌀 Weiß/Gold matt 🧱 Glas/  
Marmor/Metall  
🌀 Blanc/Doré mat 🧱 Verre/  
Marbre/Métal  
🌀 Wit/Goud mat 🧱 Glas/Marmer/  
Metaal

**3 Enja** A++-E  
max. 20 W, E27  
230 V  
⏏ 1.600 ø245 mm  
EAN 4000870 796139  
**796.13**

🌀 Weiß/Gold 🧱 Stoff/  
Marmor/Metall  
🌀 Blanc/Doré 🧱 Tissus/Marbre/  
Métal  
🌀 Wit/Goud 🧱 Textiel/Marmer/  
Metaal



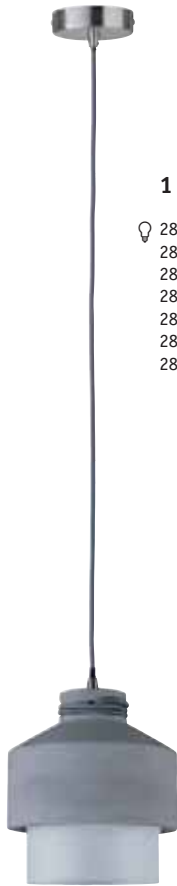

1

284.23  
283.78  
283.77  
283.76  
283.75  
283.31  
283.32



2

284.36  
283.28  
284.25  
283.92  
283.94  
283.95  
283.90  
283.91

**1 Helin** A++-E

max. 20 W, E27  
230 V  
⇅ 175 cm ø190 mm  
EAN 4000870 796160  
**796.16**



- 🌀 Grau/Satin   Beton/Glas
- 🌀 Gris/Satiné   Béton/Verre
- 🌀 Grijs/Satijn   Beton/Glas

**2 Henja** A++-E

max. 20 W, E27  
230 V  
⇅ 191 cm ø120 mm  
EAN 4000870 796184  
**796.18**





- 🌀 Grau/Eisen gebürstet   Beton/Metall
- 🌀 Gris/Acier brossé   Béton/Métal
- 🌀 Grijs/Staal geborsteld   Beton/Metaal







3

283.31  
283.32  
283.75  
283.76

**3 Helin** A++-E

max. 20 W, E27  
230 V  
⇅ 250 ø160 mm  
EAN 4000870 796191  
**796.19**

- 🌀 Grau/Satin   Beton/Glas
- 🌀 Gris/Satiné   Béton/Verre
- 🌀 Grijs/Satijn   Beton/Glas



**1 Pendulum** A++-E

max. 60 W, E27  
 230 V  
 ⌀95 mm ⌀216 cm ⌀50 mm  
 EAN 4000870 503324  
**503.32**



🔗 Grau/Schwarz 🧱 Beton/Kunststoff  
 🔗 Gris/Noir 🧱 Béton/Matière plastique  
 🔗 Grijs/Zwart 🧱 Beton/Kunststof

- 💡 283.79
- 283.80
- 283.81
- 283.88
- 283.89
- 283.90
- 283.91
- 283.92
- 283.94
- 283.95



**2 Mik** A++-E

max. 20 W, E27  
 230 V  
 ⌀130 ⌀90 mm  
 EAN 4000870 796214  
**796.21**



🔗 Grau 🧱 Beton  
 🔗 Gris 🧱 Béton  
 🔗 Grijs 🧱 Beton

**3 Ingram** A++-E

max. 20 W, E27  
 230 V  
 ⌀215 ⌀230 mm  
 EAN 4000870 796634  
**796.63**



🔗 Grau 🧱 Beton  
 🔗 Gris 🧱 Béton  
 🔗 Grijs 🧱 Beton



- 2**
- 💡 283.87
  - 283.76
  - 283.88
  - 284.57
  - 283.79
  - 283.94



- 3**
- 💡 283.73
  - 283.76
  - 283.77
  - 284.56



**1**  
 ⚡ 284.23  
 283.78  
 283.77  
 283.31  
 283.32

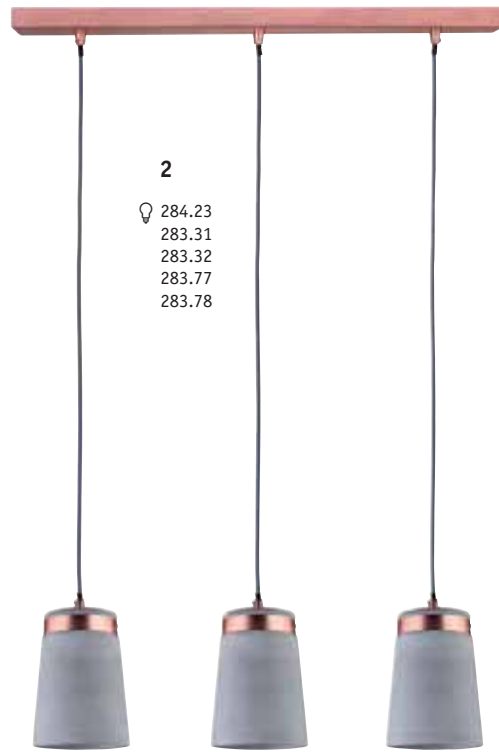

**2**  
 ⚡ 284.23  
 283.31  
 283.32  
 283.77  
 283.78



**1 Stig** A++-E

max. 20 W, E27  
 230 V  
 ⚡ 170 cm ø120 mm  
 EAN 4000870 796177  
**796.17**

⚡ Grau/Kupfer matt  
 ☒ Beton/Metall  
 ⚡ Gris/Cuivre Dépôli ☒ Béton/  
 Métal  
 ⚡ Grijs/Koper mat ☒ Beton/  
 Metaal



**2 Stig** A++-E

max. 3×20 W, E27  
 230 V  
 ⚡ 170 cm ↔ 600 mm ↻100 mm  
 EAN 4000870 796269  
**796.26**

⚡ Grau/Kupfer matt ☒ Beton/  
 Metall  
 ⚡ Gris/Cuivre Dépôli ☒ Béton/  
 Métal  
 ⚡ Grijs/Koper mat ☒ Beton/  
 Metaal





1

283.31  
283.32  
283.77  
283.78  
284.56



2

283.31  
283.32  
283.77  
283.78

**1 Oda** A++-E  
max. 20 W, E27  
230 V  
1.370 ø250 mm  
EAN 4000870 796252  
**796.25**

Weiß matt/Kupfer matt/Grau  
Metall/Beton  
Blanc dépoli/Cuivre Dépoli/Gris  
Métal/Béton  
Wit mat/Koper mat/Grijs  
Metaal/Beton

**2 Tem** A++-E  
max. 20 W, E27  
230 V  
340 ø220 mm  
EAN 4000870 796221  
**796.22**

Grau/Kupfer Stoff/  
Beton/Metall  
Gris/Cuivre Tissus/Béton/  
Métal  
Grijs/Koper Textiel/Beton/  
Metaal





**1 Norell** A++-E  
 max. 3x20 W, E27  
 230 V  
 ⚡170 cm ø200 mm ↗100 mm  
 EAN 4000870 796276  
**796.27**

- 🌀 Grau/Weiß matt/Gold matt
- 🏠 Beton/Metall
- 🌀 Gris/Blanc dépoli/Doré mat
- 🏠 Béton/Métal
- 🌀 Grijs/Wit mat/Goud mat
- 🏠 Beton/Metaal



**1**  
 ⚡ 282.10



**2**  
 ⚡ 283.88  
 284.56



**2 Yorik** A++-E  
 max. 20 W, E27  
 ✗ 103°  
 230 V  
 ⚡350 ø200 mm  
 EAN 4000870 796658  
**796.65**

- 🌀 Klar/Grau/Kupfer 🏠 Glas/  
Beton/Metall
- 🌀 Clair/Gris/Cuivre 🏠 Verre/  
Béton/Métal
- 🌀 Helder/Grijs/Koper 🏠 Glas/  
Beton/Metaal



**3 Orm** A++-E  
 max. 20 W, E27  
 ✗ 103°  
 230 V  
 ⚡500 ø150 mm  
 EAN 4000870 796245  
**796.24**

- 🌀 Grau/Kupfer matt 🏠 Metall/  
Beton
- 🌀 Gris/Cuivre Dépoli 🏠 Métal/  
Béton
- 🌀 Grijs/Koper mat 🏠 Metaal/  
Beton



**4 Orm** A++-E  
 max. 20 W, E27  
 230 V  
 ⚡500 ø150 mm  
 EAN 4000870 796238  
**796.23**

- 🌀 Weiß matt/Gold matt/Grau  
🏠 Metall/Beton
- 🌀 Blanc dépoli/Doré mat/Gris  
🏠 Métal/Béton
- 🌀 Wit mat/Goud mat/Grijs  
🏠 Metaal/Beton

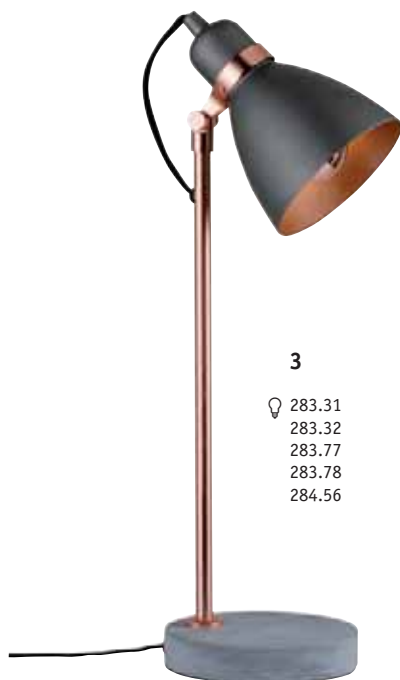

**3**  
 ⚡ 283.31  
 283.32  
 283.77  
 283.78  
 284.56



**4**  
 ⚡ 283.31  
 283.32  
 284.89  
 284.90



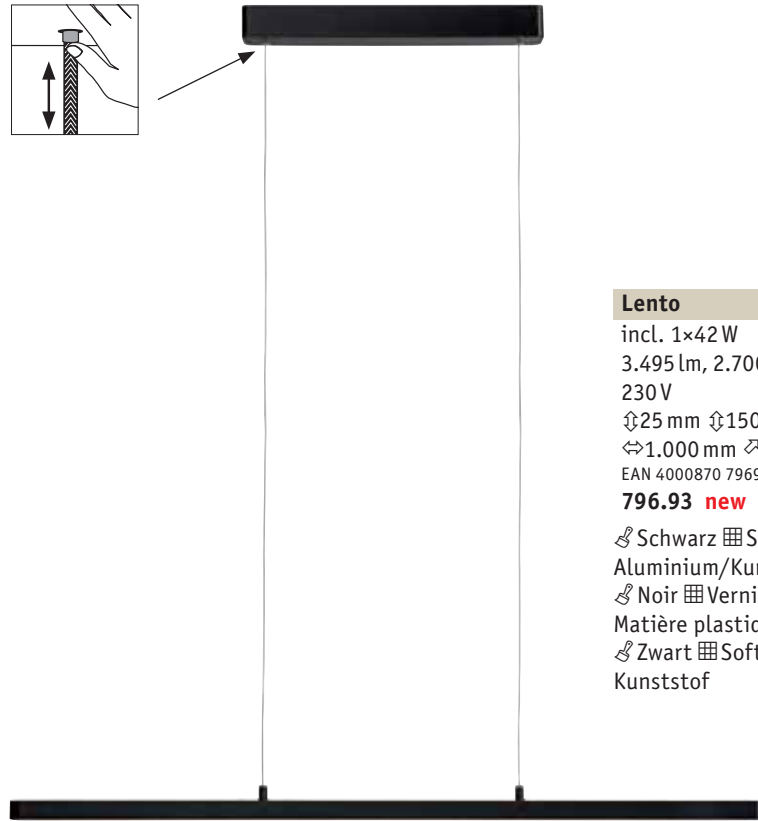
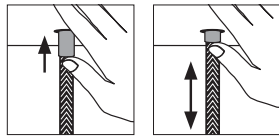

**Lento** A++-A

incl. 1x42 W  
3.495 lm, 2.700 K  
230 V  
⌀25 mm ⌀150 cm  
⇄1.000 mm ⌀35 mm  
EAN 4000870 796931

**796.93 new**

- ↳ Schwarz ▣ Softlack/ Aluminium/Kunststoff
- ↳ Noir ▣ Vernis soft/Aluminium/ Matière plastique
- ↳ Zwart ▣ Softlak/Aluminium/ Kunststof

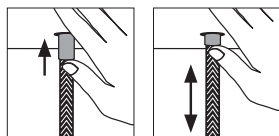

**Lento** A++-A

incl. 1x11 W  
1.200 lm, 2.700 K  
230 V  
⌀448 ⇄125 ⌀125 mm  
EAN 4000870 796955

**796.95 new**



- ↳ Schwarz ▣ Softlack/ Aluminium/Kunststoff
- ↳ Noir ▣ Vernis soft/Aluminium/ Matière plastique
- ↳ Zwart ▣ Softlak/Aluminium/ Kunststof

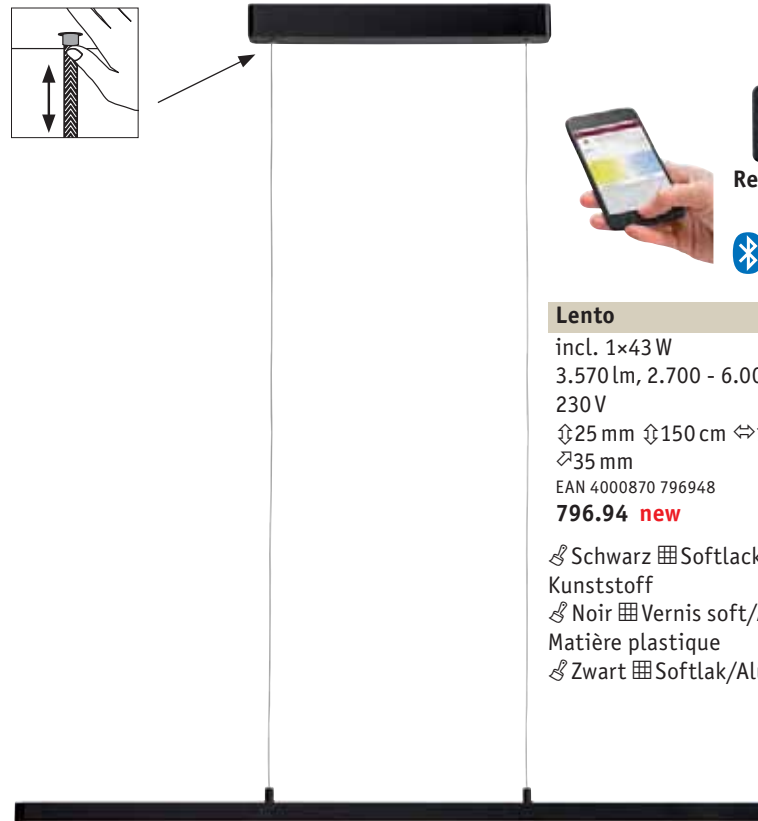

not incl.  
Remote Control  
□= 400

**Bluetooth®**

**Lento** A++-A

incl. 1x43 W  
3.570 lm, 2.700 - 6.000 K  
230 V  
⌀25 mm ⌀150 cm ⇄1.000 mm  
⌀35 mm  
EAN 4000870 796948

**796.94 new**

- ↳ Schwarz ▣ Softlack/Aluminium/ Kunststoff
- ↳ Noir ▣ Vernis soft/Aluminium/ Matière plastique
- ↳ Zwart ▣ Softlak/Aluminium/ Kunststof





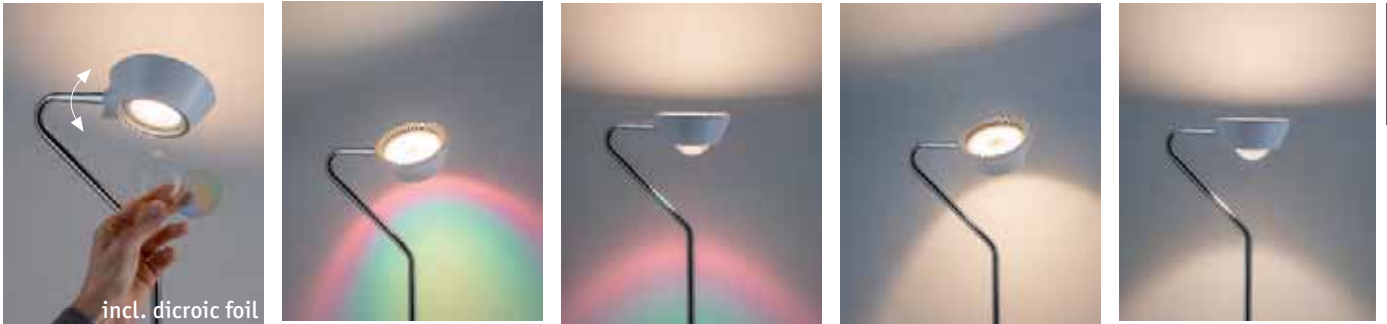

**Ramos** A++-A

incl. 1x4,5 / 1x3,5 W  
500 + 350 lm, 2.700 K  
230 V  
⌀440 ø120 mm  
EAN 4000870 709214  
**709.21 new**

LED  
 dimmable  
 incl.  
 On/Off

Weiß matt/Chrom  
 Kunststoff/Metall  
 Blanc dépoli/Chrome  
 Matière plastique/Métal  
 Wit mat/Chroom Kunststof/Metaal

**Ramos** A++-A

incl. 1x7,5 / 1x3,5 W  
840 + 320 lm, 2.700 K  
230 V  
⌀1.415 ø226 mm  
EAN 4000870 709207  
**709.20 new**

LED  
 dimmable  
 incl.  
 On/Off

Weiß matt/Chrom  
 Kunststoff/Metall  
 Blanc dépoli/Chrome  
 Matière plastique/Métal  
 Wit mat/Chroom Kunststof/Metaal



**Arik** A++-A

incl. 1x20 W  
2.345 lm, 2.700 K  
230 V  
⌀1.600 ⌀266 mm  
EAN 4000870 797075  
**797.07 new**

LED  
 dimmable  
 On/Off

Weiß/Alu gebürstet  
 Metall  
 Blanc/Alu brossé Métal  
 Wit/Alu geborsteld Metaal

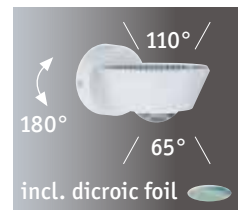

**Sabik** A++-A

incl. 1x9 / 1x4 W  
800 + 390 lm, 2.700 K  
230 V  
⌀80 ⇄117 ⌀152 mm  
EAN 4000870 709467  
**709.46 new**

LED  
 IP44

Weiß matt Kunststoff  
 Blanc dépoli  
 Matière plastique  
 Wit mat Kunststof

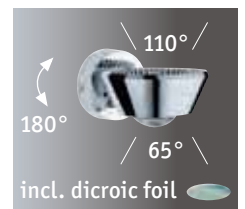

**Sabik** A++-A

incl. 1x9 / 1x4 W  
800 + 390 lm, 2.700 K  
230 V  
⌀80 ⇄117 ⌀152 mm  
EAN 4000870 709474  
**709.47 new**

LED  
 IP44

Chrom Kunststoff  
 Chrome Matière plastique  
 Chroom Kunststof

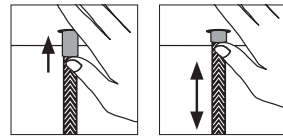
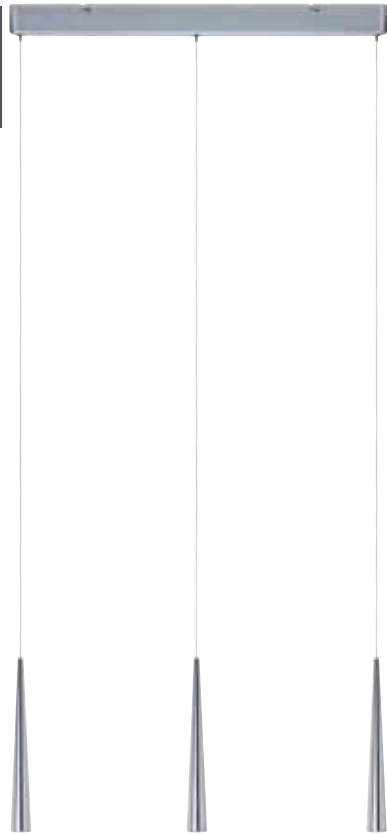

**Gutta** A++-A  
 incl. 3x7 W  
 3x600 lm, 2.700 K  
 230 V  
 ⌀150 cm ø33 mm ↔670 mm  
 ⌀36 mm  
 EAN 4000870 709306  
**709.30 new**

- 🔧 Alu gebürstet 🏠 Metall
- 🔧 Alu brossé 🏠 Métal
- 🔧 Alu geborsteld 🏠 Metaal



**Gutta** A++-A  
 incl. 1x7 W  
 600 lm, 2.700 K  
 230 V  
 ⌀150 cm ø72 mm  
 EAN 4000870 709290  
**709.29 new**

- 🔧 Alu gebürstet 🏠 Metall
- 🔧 Alu brossé 🏠 Métal
- 🔧 Alu geborsteld 🏠 Metaal

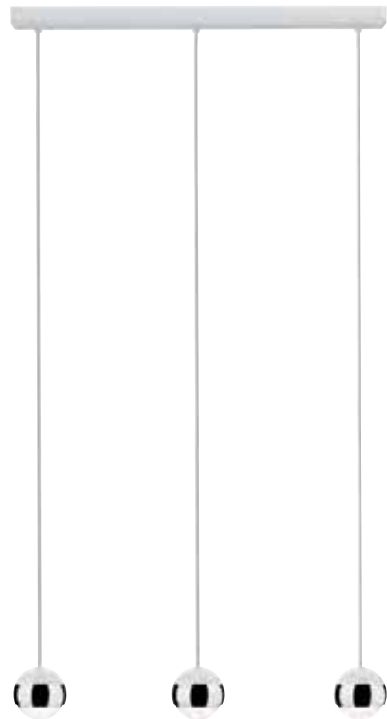

**Capsule** A++-A  
 incl. 3x6 W  
 3x420 lm, 2.700 K  
 < 130°  
 230 V  
 ⌀152 cm ↔640 mm  
 EAN 4000870 709276  
**709.27 new**

- 🔧 Weiß/Chrom 🏠 Glas/Metall
- 🔧 Blanc/Chrome 🏠 Verre/Métal
- 🔧 Wit/Chroom 🏠 Glas/Metaal



**Capsule** A++-A  
 incl. 1x6 W  
 420 lm, 2.700 K  
 < 130°  
 230 V  
 ⌀152 cm ø87 mm  
 EAN 4000870 709269  
**709.26 new**

- 🔧 Weiß/Chrom 🏠 Glas/Metall
- 🔧 Blanc/Chrome 🏠 Verre/Métal
- 🔧 Wit/Chroom 🏠 Glas/Metaal

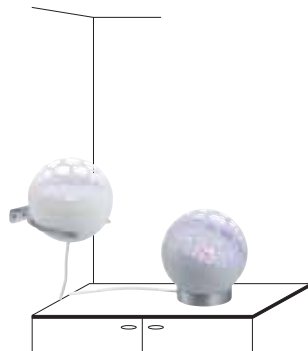

**Favia**

incl. 1x6 W  
300 lm  
ø100 mm  
EAN 4000870 796962  
**796.96 new**

- 👉 Weiß Kunststoff
- 👉 Blanc Matière plastique
- 👉 Wit Kunststof

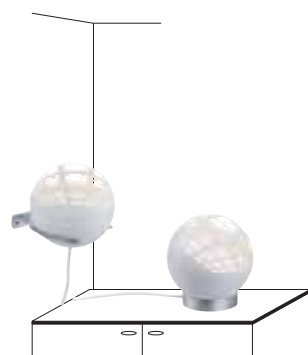

**Favia**

incl. 1x5 W  
340 lm, 2.700 K  
ø100 mm  
EAN 4000870 796979  
**796.97 new**

- 👉 Weiß Kunststoff
- 👉 Blanc Matière plastique
- 👉 Wit Kunststof





 **not incl.**  
**Remote Control**  
□= 400



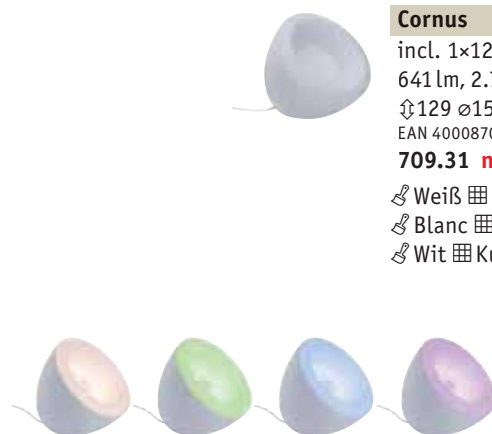



 **Bluetooth®**



**Cornus**

incl. 1x12 W  
641 lm, 2.700 K  
∅129 ∅150 mm  
EAN 4000870 709313

**709.31 new**



-  Weiß  Kunststoff
-  Blanc  Matière plastique
-  Wit  Kunststof



**Cornus**

incl. 1x7,6 W  
725 lm, 2.700 K  
∅129 ∅150 mm  
EAN 4000870 709320

**709.32 new**

-  Weiß  Kunststoff
-  Blanc  Matière plastique
-  Wit  Kunststof







# 3D Glass



- ☞ Klar 田 Acryl
- ☞ Clair 田 Acryl
- ☞ Helder 田 Acryl



1



2



3



4



5

### 3D Mesh Glass

ø230 ø10 mm  
EAN 4000870 795347  
**795.34**

### 3D Maze Glass

ø230 ø10 mm  
EAN 4000870 795323  
**795.32**

### 3D Yarn Glass

ø230 ø10 mm  
EAN 4000870 795316  
**795.31**

### 3D Wool Glass

ø230 ø10 mm  
EAN 4000870 795330  
**795.33**

### 3D Twine Glass

ø230 ø10 mm  
EAN 4000870 795378  
**795.37**



### 3D Basic

incl. 1×3 W  
270 lm  
230 V, incl. 田 4 VA  
⌀33 ø104 ø10 mm  
EAN 4000870 795354  
**795.35**

A++-A

LED

incl.

田

On/Off

- ☞ Weiß matt 田 Alu
- ☞ Blanc dépoli 田 Alu
- ☞ Wit mat 田 Alu

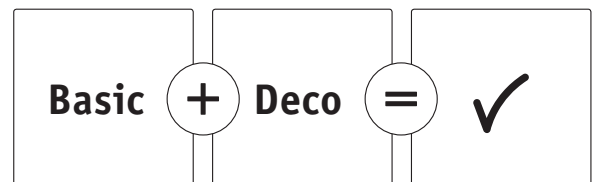

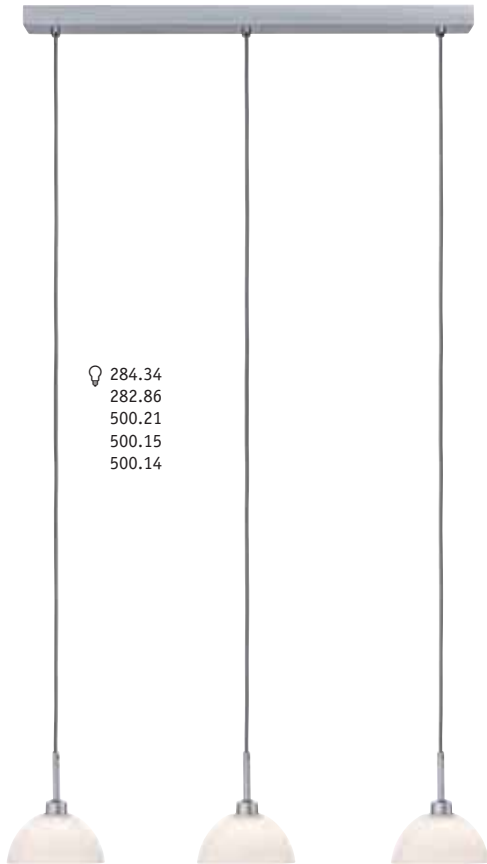

💡 284.34  
282.86  
500.21  
500.15  
500.14

**Parana** A++-E  
max. 3x40 W, GU10  
230 V  
↕ 157 cm ↔ 690 mm  
EAN 4000870 709252  
**709.25 new**  
🔗 Weiß/Chrom matt 🧱 Glas/Metall  
🔗 Blanc/Chrome mat 🧱 Verre/Métal  
🔗 Wit/Chroom mat 🧱 Glas/Metaal



💡 283.31

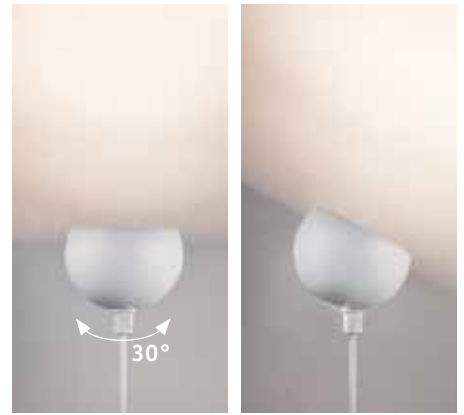

**Gambia** A++-E  
max. 60 W, E27  
230 V  
↕ 1.522 ø 300 mm  
EAN 4000870 709283  
**709.28 new**  
🔗 Weiß matt 🧱 Metall  
🔗 Blanc dépoli 🧱 Métal  
🔗 Wit mat 🧱 Metaal



💡 283.34  
283.70

**Kelt** A++-E  
max. 20 W, E14  
230 V  
↕ 370 ø 230 mm  
EAN 4000870 797341  
**797.34 new**  
🔗 Grau 🧱 Stoff  
🔗 Gris 🧱 Tissus  
🔗 Grijs 🧱 Textiel



💡 283.31  
283.77  
283.32  
283.78

**Kelt** A++-E  
max. 20 W, E27  
230 V  
↕ 620 ø 350 mm  
EAN 4000870 797358  
**797.35 new**  
🔗 Grau 🧱 Stoff  
🔗 Gris 🧱 Tissus  
🔗 Grijs 🧱 Textiel





**Tessa**

max. 60 W, E27  
230 V  
150 cm ø450 mm  
EAN 4000870 709245

**709.24 new**

- ☞ Creme/Eisen gebürstet
- ☞ Metall/Stoff
- ☞ Crème/Acier brossé ☞ Métal/Tissus
- ☞ Crème/Staal geborsteld
- ☞ Metaal/Textiel

A++-E



- 💡 284.47
- 284.69
- 284.86
- 284.23
- 500.11
- 500.12
- 500.13
- 500.52
- 500.53
- 500.54



- 💡 282.95
- 283.70
- 500.55
- 500.56

**Tessa**

max. 40 W, E14  
230 V  
450 ø250 mm  
EAN 4000870 709238

**709.23 new**

- ☞ Creme/Eisen gebürstet
- ☞ Metall/Stoff
- ☞ Crème/Acier brossé ☞ Métal/Tissus
- ☞ Crème/Staal geborsteld
- ☞ Metaal/Textiel

A++-E

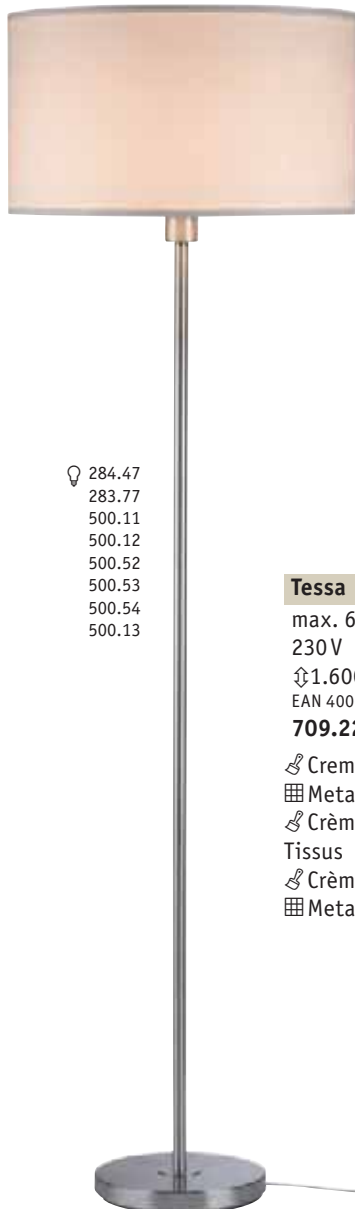

- 💡 284.47
- 283.77
- 500.11
- 500.12
- 500.52
- 500.53
- 500.54
- 500.13

**Tessa**

max. 60 W, E27  
230 V  
1.600 ø450 mm  
EAN 4000870 709221

**709.22 new**

- ☞ Creme/Eisen gebürstet
- ☞ Metall/Stoff
- ☞ Crème/Acier brossé ☞ Métal/Tissus
- ☞ Crème/Staal geborsteld
- ☞ Metaal/Textiel

A++-E





💡 283.31  
283.77  
283.32  
283.78

**Benue**

max. 60 W, E27

230 V

⬆️1.835 ⬇️1.860 ↗️430 mm

EAN 4000870 797297

**797.29 new**

A++-E

incl.



On/Off

- 🔗 Beige/Schwarz 📏 Stoff/Metall
- 🔗 Beige/Noir 📏 Tissus/Métal
- 🔗 Beige/Zwart 📏 Textiel/Metaal





**Seja** A++-E

max. 20 W, E27  
 230 V  
 ⚡465 ↔300 ↻300 mm  
 EAN 4000870 797327  
**797.32 new**

🔧 Eisen gebürstet 📏 Metall  
 🔧 Acier brossé 📏 Métal  
 🔧 Staal geborsteld 📏 Metaal

💡 283.31  
 283.32



**Kura** A++-E

max. 20 W, E27  
 230 V  
 ⚡85 ↔85 ↻85 mm  
 EAN 4000870 797303  
**797.30 new**

🔧 Eisen gebürstet 📏 Metall  
 🔧 Acier brossé 📏 Métal  
 🔧 Staal geborsteld 📏 Metaal

💡 283.87  
 283.99



 **not incl.**  
**Remote Control**  
 ☐= 402



**Siegen** A++-E

incl. 1x7,5 W, E27, A\*

650 lm, 2.700 K  
 230 V  
 ⚡190 ø200 mm  
 EAN 4000870 501023  
**501.02**

🔧 Opal/Satin 📏 Glas  
 🔧 Opale/Satiné 📏 Verre  
 🔧 Opaal/Satijn 📏 Glas

💡 500.54

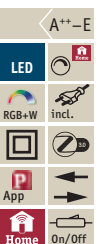

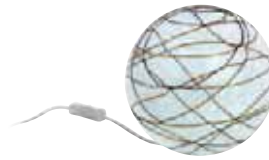

💡 283.70  
894.35

**Giba**

A++-E

max. 25 W, E14  
230 V  
⌀140 ø150 mm  
EAN 4000870 660522

**660.52**

👉 Nickel satiniert/Opal/  
Braun 🗍 Metall/Glas  
👉 Nickel satiné/Opale/Brun  
🗍 Métal/Verre  
👉 Nikkel gesatineerd/Opaal/Bruin  
🗍 Metaal/Glas



💡 283.63  
283.70  
314.66

**Kiia**

A++-E

max. 40 W, E14  
230 V  
⌀195 ø200 mm  
EAN 4000870 770320

**770.32**

👉 Opal 🗍 Glas  
👉 Opale 🗍 Verre  
👉 Opaal 🗍 Glas



💡 283.63  
283.70  
314.66  
894.35

**Wilma**

A++-E

max. 40 W, E14  
230 V  
⌀200 ⇄100 ↗100 mm  
EAN 4000870 770313

**770.31**

👉 Opal 🗍 Glas  
👉 Opale 🗍 Verre  
👉 Opaal 🗍 Glas



💡 314.66

**Jenni**

A++-E

max. 40 W, E14  
230 V  
⌀220 ⇄100 ↗100 mm  
EAN 4000870 770375

**770.37**

👉 Nickel satiniert/Opal 🗍 Metall/  
Glas  
👉 Nickel satiné/Opale 🗍 Métal/  
Verre  
👉 Nikkel gesatineerd/Opaal  
🗍 Metaal/Glas





314.66



### Pinja

A++-E

max. 40 W, E14

230 V

∅240 ∅110 mm

EAN 4000870 770290

**770.29**

- 🔧 Chrom/Opal 🏠 Metall/Glas
- 🔧 Chrome/Opale 🏠 Métal/Verre
- 🔧 Chroom/Opaal 🏠 Metaal/Glas



### Plaza

A++-A

incl. 1x3 W

240 lm, 6.000 - 7.000 K

∠ 120°

230 V

∅750 ∅250 mm

EAN 4000870 749951

**749.95**

- 🔧 Eisen gebürstet 🏠 Metall
- 🔧 Acier brossé 🏠 Métal
- 🔧 Staal geborsteld 🏠 Metaal



### Zed LED

A++-A

incl. 1x6,7 W

359 lm, 3.000 K

230 V

∅475 ∅160 mm

EAN 4000870 702451

**702.45**

- 🔧 Eisen gebürstet 🏠 Metall
- 🔧 Acier brossé 🏠 Métal
- 🔧 Staal geborsteld 🏠 Metaal



284.41  
284.42



### Sara

A++-E

max. 60 W, E14

230 V

∅980 ∅180 mm

EAN 4000870 770252

**770.25**

- 🔧 Silber 🏠 Metall
- 🔧 Argent 🏠 Métal
- 🔧 Zilver 🏠 Metaal





# Galeria

- 96 Galeria
- 100 Mirror
- 102 Assistent



97 Galeria Beam Sixty



98 Galeria Double Bow



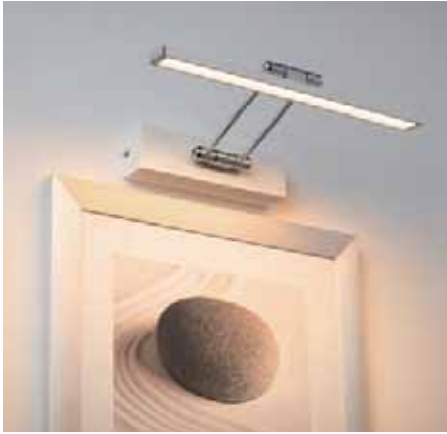

⌘ Weiß/Chrom ⌘ Metall  
 ⌘ Blanc/Chrome ⌘ Métal  
 ⌘ Wit/Chroom ⌘ Metaal



**Beam Thirty**

A++-A

incl. 1x5 W  
 630 lm, 2.700 K  
 <math>\sphericalangle 100^\circ</math>, 220 cd  
 230 V  
 ⌘46 ⌘290 ⌘190 mm  
 EAN 4000870 998915  
**998.91**



**Beam Fifty**

A++-A

incl. 1x7 W  
 850 lm, 2.700 K  
 <math>\sphericalangle 100^\circ</math>, 350 cd  
 230 V  
 ⌘46 ⌘450 ⌘190 mm  
 EAN 4000870 998922  
**998.92**



**Beam Sixty**

A++-A

incl. 1x11 W  
 1.250 lm, 2.700 K  
 <math>\sphericalangle 100^\circ</math>, 430 cd  
 230 V  
 ⌘46 ⌘585 ⌘190 mm  
 EAN 4000870 998939  
**998.93**



⌘ Nickel gebürstet/Chrom ⌘ Metall  
 ⌘ Nickel brossé/Chrome ⌘ Métal  
 ⌘ Nikkel geborsteld/Chroom ⌘ Metaal



**Beam Thirty**

A++-A

incl. 1x5 W  
 630 lm, 2.700 K  
 <math>\sphericalangle 100^\circ</math>, 220 cd  
 230 V  
 ⌘46 ⌘290 ⌘190 mm  
 EAN 4000870 998946  
**998.94**



**Beam Fifty**

A++-A

incl. 1x7 W  
 850 lm, 2.700 K  
 <math>\sphericalangle 100^\circ</math>, 350 cd  
 230 V  
 ⌘46 ⌘450 ⌘190 mm  
 EAN 4000870 998953  
**998.95**



**Beam Sixty**

A++-A

incl. 1x11 W  
 1.250 lm, 2.700 K  
 <math>\sphericalangle 100^\circ</math>, 430 cd  
 230 V  
 ⌘46 ⌘585 ⌘190 mm  
 EAN 4000870 998960  
**998.96**





⌘ Chrom ⌘ Metall  
 ⌘ Chrome ⌘ Métal  
 ⌘ Chroom ⌘ Metaal



**Beam Thirty**

A++-A

incl. 1x5 W  
 630 lm, 2.700 K  
 ∠ 100°, 220 cd  
 230 V  
 ⌀46 ⇄290 ⌀190 mm  
 EAN 4000870 998885  
**998.88**



**Beam Fifty**

A++-A

incl. 1x7 W  
 850 lm, 2.700 K  
 ∠ 100°, 350 cd  
 230 V  
 ⌀46 ⇄450 ⌀190 mm  
 EAN 4000870 998892  
**998.89**



**Beam Sixty**

A++-A

incl. 1x11 W  
 1.250 lm, 2.700 K  
 ∠ 100°, 430 cd  
 230 V  
 ⌀46 ⇄585 ⌀190 mm  
 EAN 4000870 998908  
**998.90**



⌘ Chrom/Transparent ⌘ Metall/Acryl  
 ⌘ Chrome/Transparent ⌘ Métal/Acryl  
 ⌘ Chroom/Transparant ⌘ Metaal/Acryl



**Block**

A++-A

incl. 1x5 W  
 420 lm, 2.700 K  
 230 V  
 ⌀46 ⇄335 ⌀95 mm  
 EAN 4000870 998977  
**998.97**



**Block**

A++-A

incl. 1x7 W  
 640 lm, 2.700 K  
 230 V  
 ⌀46 ⇄505 ⌀95 mm  
 EAN 4000870 998984  
**998.98**



**Block**

A++-A

incl. 1x9,5 W  
 790 lm, 2.700 K  
 230 V  
 ⌀46 ⇄675 ⌀95 mm  
 EAN 4000870 998991  
**998.99**



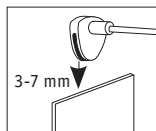

**Galeria Double Bow**

A++-A

incl. 2×3,2W  
2×378 lm, 2.700 K  
∠ 100°  
230V  
∅105 ⇄300 ↗145 mm  
EAN 4000870 993811

LED



**993.81**

- 🔩 Chrom 📏 Metall
- 🔩 Chrome 📏 Métal
- 🔩 Chroom 📏 Metaal

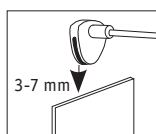

**Galeria Bow**

A++-A

incl. 1×3,2W  
378 lm, 2.700 K  
∠ 100°  
230V  
∅123 ⇄30 ↗230 mm  
EAN 4000870 993804

LED



**993.80**

- 🔩 Chrom 📏 Metall
- 🔩 Chrome 📏 Métal
- 🔩 Chroom 📏 Metaal

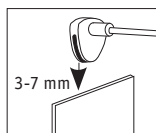

**Galeria Double Hook**

A++-A

incl. 2×3,2W  
2×378 lm, 2.700 K  
∠ 100°  
230V  
∅80 ⇄300 ↗110 mm  
EAN 4000870 993859

LED



**993.85 new**

- 🔩 Chrom 📏 Metall
- 🔩 Chrome 📏 Métal
- 🔩 Chroom 📏 Metaal

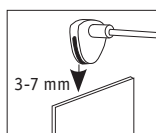

**Galeria Hook**

A++-A

incl. 1×3,2W  
378 lm, 2.700 K  
∠ 100°  
230V  
∅18 ⇄150 ↗70 mm  
EAN 4000870 990896

LED



**990.89**

- 🔩 Chrom 📏 Metall
- 🔩 Chrome 📏 Métal
- 🔩 Chroom 📏 Metaal

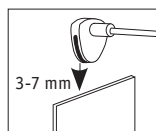

**Galeria Frame**

A++-A

incl. 1×4,2 W  
 378 lm, 2.700 K  
 <math>\sphericalangle 110^\circ</math>  
 230 V  
 <math>\hat{H} 95 \hat{L} 50 \hat{D} 125 \text{ mm}</math>  
 EAN 4000870 990797

LED

**990.79**

Chrom Metall  
 Chrome Métal  
 Chroom Metaal

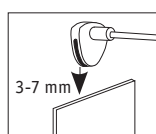
**Galeria Wave**

A++-A

incl. 1×3,2 W  
 378 lm, 2.700 K  
 <math>\sphericalangle 100^\circ</math>  
 230 V  
 <math>\hat{H} 30 \hat{L} 30 \hat{D} 172 \text{ mm}</math>  
 EAN 4000870 991008

LED

**991.00**

Chrom Metall  
 Chrome Métal  
 Chroom Metaal

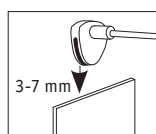
**Galeria Ring**

A++-A

incl. 1×3,2 W  
 378 lm, 2.700 K  
 <math>\sphericalangle 100^\circ</math>  
 230 V  
 <math>\hat{H} 30 \hat{\varnothing} 100 \hat{D} 110 \text{ mm}</math>  
 EAN 4000870 990865

LED

**990.86**

Chrom Metall  
 Chrome Métal  
 Chroom Metaal

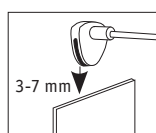
**Galeria Oval**

A++-A

incl. 1×3,2 W  
 378 lm, 2.700 K  
 <math>\sphericalangle 100^\circ</math>  
 230 V  
 <math>\hat{H} 30 \hat{L} 100 \hat{D} 70 \text{ mm}</math>  
 EAN 4000870 990889

LED

**990.88**

Chrom Metall  
 Chrome Métal  
 Chroom Metaal





283.69



**Mirror Regula**

max. 3×40W, E14  
230V  
75 ⇄ 420 50 mm  
EAN 4000870 996799  
**996.79**

A++-E



**Mirror Regula**

max. 5×40W, E14  
230V  
75 ⇄ 650 50 mm  
EAN 4000870 996805  
**996.80**

A++-E



- Chrom Metall
- Chrome Métal
- Chroom Metaal



**Mirror Zylindro**

incl. 1×3W  
120lm, 2.700K  
60°  
230V, incl. 3VA  
260 ⇄ 80 235 mm  
EAN 4000870 990681  
**990.68**

A++-A



- Chrom Metall
- Chrome Métal
- Chroom Metaal



283.38



**Mirror Calami LED**

incl. 2×2,2W, G9, A++  
2×200lm, 2.700K  
230V  
60 ⇄ 275 190 mm  
EAN 4000870 998670  
**998.67**

A++-E



- Eisen gebürstet Metall
- Acier brossé Métal
- Staal geborsteld Metaal

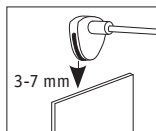

284.10  
284.34



**Mirror Simplo LED**

A++-E

incl. 1x5,3 W, GU10, A+  
345 lm, 2.700 K  
230 V  
∅60 ø51 ↔30 ↗100 mm  
EAN 4000870 999059

LED



- 🔧 Eisen gebürstet 📦 Metall
- 🔧 Acier brossé 📦 Métal
- 🔧 Staal geborsteld 📦 Metaal

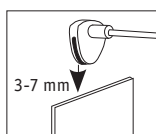

283.38  
284.46



**Mirror Vitrino LED**

A++-E

incl. 1x2,2 W, G9, A+  
200 lm, 2.700 K  
230 V  
∅125 ø35 ↔15 ↗100 mm  
EAN 4000870 999073

LED



- 🔧 Eisen gebürstet/Opal 📦 Metall/  
Glas
- 🔧 Acier brossé/Opale 📦 Métal/  
Verre
- 🔧 Staal geborsteld/Opaal  
📦 Metaal/Glas

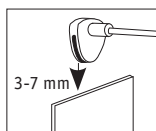

283.38  
284.46



**Mirror Curvus LED**

A++-E

incl. 1x2,2 W, G9, A+  
200 lm, 2.700 K  
230 V  
∅230 ø60 ↔30 ↗120 mm  
EAN 4000870 999066

LED



- 🔧 Eisen gebürstet/Opal 📦 Metall/  
Glas
- 🔧 Acier brossé/Opale 📦 Métal/  
Verre
- 🔧 Staal geborsteld/Opaal  
📦 Metaal/Glas

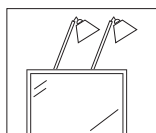

283.01



**Galeria LED II**

A++-E

incl. 2x4 W, GU5,3, A+  
2x230 lm, 2.700 K  
230 V, incl. 12 VA  
∅300 ø51 ↔25 ↗180 mm  
EAN 4000870 999080

LED



- 🔧 Chrom 📦 Metall
- 🔧 Chrome 📦 Métal
- 🔧 Chromom 📦 Metaal

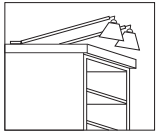

**Assistent II LED**

A++-E

incl. 2x4 W, GU5,3, **A+**  
 2x230 lm, 2.700 K  
 230 V, incl. 12 VA  
 ⌀170 ø51 ⇄25 ↗460 mm  
 EAN 4000870 999097

LED



On/Off

**999.09**

- 🔩 Chrom 

--

 Metall
- 🔩 Chrome 

--

 Métal
- 🔩 Chroom 

--

 Metaal

💡 283.01

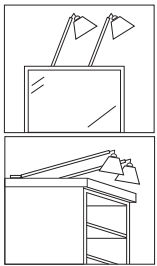

**Assistent Butler LED**

A++-E

incl. 2x4 W, GU5,3, **A+**  
 2x230 lm, 2.700 K  
 incl. 12 VA  
 ⌀50 ø51 ⇄32 ↗170-600 mm  
 EAN 4000870 999004

LED



**999.00**

- 🔩 Schwarz 

--

 Metall
- 🔩 Noir 

--

 Métal
- 🔩 Zwart 

--

 Metaal

💡 283.01



**Assistent Finja LED**

A++-E

incl. 1x6,5 W, GU10, **A+**  
 425 lm, 2.700 K  
 230 V  
 ⌀330 ø51 ⇄115 mm  
 EAN 4000870 998687

LED

incl.



On/Off

**998.68**

- 🔩 Chrom matt 

--

 Metall/Kunststoff
- 🔩 Chrome mat 

--

 Métal/Matière plastique
- 🔩 Chroom mat 

--

 Metaal/Kunststof

💡 283.00  
 284.10



**Assistent Gesa LED**

A++-E

incl. 1x3,5 W, GU10, **A+**  
 230 lm, 2.700 K  
 230 V  
 ⌀282 ø51 ⇄115 mm  
 EAN 4000870 999103

LED

incl.



On/Off

**999.10**

- 🔩 Chrom matt 

--

 Metall/Kunststoff
- 🔩 Chrome mat 

--

 Métal/Matière plastique
- 🔩 Chroom mat 

--

 Metaal/Kunststof

💡 282.99  
 284.10



**Assistent Gryps**

A++-E

max. 40 W, E14  
 230 V  
 ⌀150 ø60 ⇄115 mm  
 EAN 4000870 998250

incl.



On/Off

**998.25**

- 🔩 Eisen gebürstet 

--

 Metall/Kunststoff
- 🔩 Acier brossé 

--

 Métal/Matière plastique
- 🔩 Staal geborsteld 

--

 Metaal/Kunststof

💡 282.93



# Spotlights

- 104 LED
- 111 LED IP44



107 Frame



111 Zyli IP44





🔩 Chrom 🔩 Metall  
🔩 Chrome 🔩 Métal  
🔩 Chroom 🔩 Metaal



**Bowl** ◀ A++-A

incl. 1×3,2 W  
 298 lm, 2.700 K  
 ✂ 95°  
 230 V  
 ø90 ↗115 mm  
 EAN 4000870 603826  
**603.82**

LED  
🔲  
🔌 On/Off



**Bowl** ◀ A++-A

incl. 2×3,2 W  
 2×298 lm, 2.700 K  
 ✂ 95°  
 230 V  
 ⚡140 ↔275 ↗198 mm  
 EAN 4000870 603833  
**603.83**

LED  
🔲



**Bowl** ◀ A++-A

incl. 4×3,2 W  
 4×298 lm, 2.700 K  
 ✂ 95°  
 230 V  
 ⚡150 ↔690 ↗135 mm  
 EAN 4000870 603857  
**603.85**

LED  
🔲



**Bowl** ◀ A++-A

incl. 6×3,2 W  
 6×298 lm, 2.700 K  
 ✂ 95°  
 230 V  
 ⚡165 ↔1.650 ↗135 mm  
 EAN 4000870 603864  
**603.86**

LED  
🔲

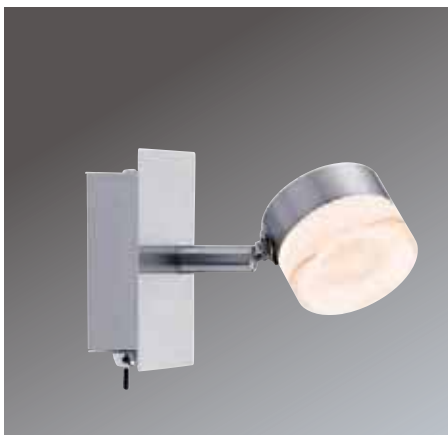

🔩 Eisen gebürstet 🔩 Metall  
🔩 Acier brossé 🔩 Métal  
🔩 Staal geborsteld 🔩 Metaal



**Slice** ◀ A++-A

incl. 1×4,3 W  
 258 lm, 3.000 K  
 ✂ 115°  
 230 V  
 ⚡110 ↔110 ↗130 mm  
 EAN 4000870 603772  
**603.77**

LED  
🔲  
🔌 On/Off



**Slice** ◀ A++-A

incl. 4×4,3 W  
 4×258 lm, 3.000 K  
 ✂ 115°  
 230 V  
 ⚡92 ↔580 ↗75 mm  
 EAN 4000870 603802  
**603.80**

LED  
🔲



**Slice** ◀ A++-A

incl. 4×4,3 W  
 4×258 lm, 3.000 K  
 ✂ 115°  
 230 V  
 ⚡110 ↔250 ↗250 mm  
 EAN 4000870 603819  
**603.81**

LED  
🔲



⚙ Weiß matt/Chrom   Metall/Acryl  
 ⚙ Blanc dépoli/Chrome   Métal/Acryl  
 ⚙ Wit mat/Chroom   Metaal/Acryl

**Clear**

A++-A

incl. 1×4,3 W  
 409 lm, 3.000 K  
 230 V  
 ⌀90 ⇔130 ⌀80 mm  
 EAN 4000870 666623  
**666.62**

LED

**Clear**

A++-A

incl. 2×4,3 W  
 2×409 lm, 3.000 K  
 230 V  
 ⌀140 ⇔305 ⌀80 mm  
 EAN 4000870 666630  
**666.63**

LED

**Clear**

A++-A

incl. 3×4,3 W  
 3×409 lm, 3.000 K  
 230 V  
 ⌀140 ⇔485 ⌀80 mm  
 EAN 4000870 666647  
**666.64**

LED

**Clear**

A++-A

incl. 4×4,3 W  
 4×409 lm, 3.000 K  
 230 V  
 ⌀150 ⇔785 ⌀90 mm  
 EAN 4000870 666654  
**666.65**

LED



⚙ Alu gebürstet/Chrom   Metall/Acryl  
 ⚙ Alu brossé/Chrome   Métal/Acryl  
 ⚙ Alu geborsteld/Chroom   Metaal/Acryl

**Hemisphere**

A++-A

incl. 1×4,5 W  
 439 lm, 3.000 K  
 ✗ 120°  
 230 V  
 ⌀80 ⇔178 ⌀130 mm  
 EAN 4000870 666302  
**666.30**

LED

**Hemisphere**

A++-A

incl. 2×4,5 W  
 2×439 lm, 3.000 K  
 ✗ 120°  
 230 V  
 ⌀130 ⇔310 ⌀80 mm  
 EAN 4000870 666319  
**666.31**

LED

**Hemisphere**

A++-A

incl. 3×4,5 W  
 3×439 lm, 3.000 K  
 ✗ 120°  
 230 V  
 ⌀130 ⇔470 ⌀80 mm  
 EAN 4000870 666326  
**666.32**

LED

**Hemisphere**

A++-A

incl. 4×4,5 W  
 4×439 lm, 3.000 K  
 ✗ 120°  
 230 V  
 ⌀130 ⇔250 ⌀250 mm  
 EAN 4000870 666333  
**666.33**

LED



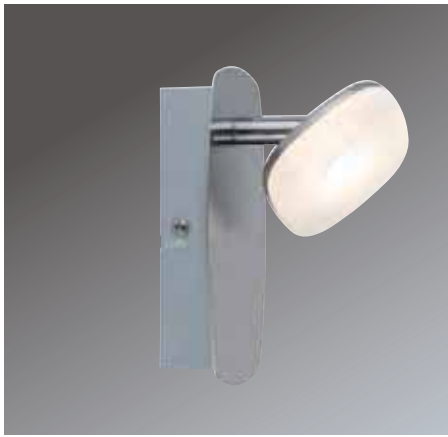

🔩 Nickel 📏 Metall/Acryl  
🔩 Nickel 📏 Métal/Acryl  
🔩 Nikkel 📏 Metaal/Acryl

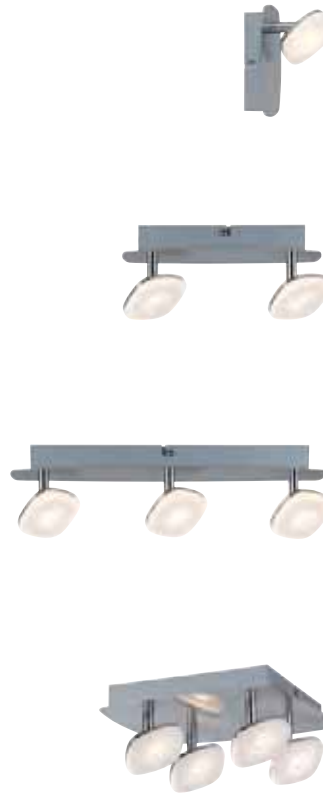

**Squarelense** ◀ A++-A

incl. 1×3,2 W  
 343 lm, 3.000 K  
 230 V  
 ⌀86 ⇄140 ⌀85 mm  
 EAN 4000870 666500  
**666.50**

LED 📏 🔌 On/Off

**Squarelense** ◀ A++-A

incl. 2×3,2 W  
 2×343 lm, 3.000 K  
 230 V  
 ⌀95 ⇄230 ⌀80 mm  
 EAN 4000870 666517  
**666.51**

LED 📏

**Squarelense** ◀ A++-A

incl. 3×3,2 W  
 3×343 lm, 3.000 K  
 230 V  
 ⌀95 ⇄380 ⌀80 mm  
 EAN 4000870 666524  
**666.52**

LED 📏

**Squarelense** ◀ A++-A

incl. 4×3,2 W  
 4×343 lm, 3.000 K  
 230 V  
 ⌀95 ⇄250 ⌀250 mm  
 EAN 4000870 666531  
**666.53**

LED 📏



🔩 Chrom 📏 Metall  
🔩 Chrome 📏 Métal  
🔩 Chroom 📏 Metaal



**Mic** ◀ A++-A

incl. 1×4,5 W  
 489 lm, 3.000 K  
 ✗ 110°  
 230 V  
 ⌀80 ⇄140 ⌀160 mm  
 EAN 4000870 666425  
**666.42**

LED 📏 🔌 On/Off

**Mic** ◀ A++-A

incl. 2×4,5 W  
 2×489 lm, 3.000 K  
 ✗ 110°  
 230 V  
 ⌀160 ⇄280 ⌀80 mm  
 EAN 4000870 666432  
**666.43**

LED 📏

**Mic** ◀ A++-A

incl. 3×4,5 W  
 3×489 lm, 3.000 K  
 ✗ 110°  
 230 V  
 ⌀160 ⇄430 ⌀80 mm  
 EAN 4000870 666449  
**666.44**

LED 📏

**Mic** ◀ A++-A

incl. 4×4,5 W  
 4×489 lm, 3.000 K  
 ✗ 110°  
 230 V  
 ⌀160 ⇄250 ⌀250 mm  
 EAN 4000870 666456  
**666.45**

LED 📏



⚙ Chrom/Klar 🗪 Metall/Acryl  
 ⚙ Chrome/Clair 🗪 Métal/Acryl  
 ⚙ Chroom/Helder 🗪 Metaal/Acryl

**Window**

A++-A

incl. 1×5 W  
 381 lm, 3.000 K  
 230 V  
 ⌀130 ⇄80 ↻80 mm  
 EAN 4000870 666661  
**666.66**

LED



On/Off

**Window**

A++-A

incl. 2×5 W  
 2×381 lm, 3.000 K  
 230 V  
 ⌀190 ⇄308 ↻80 mm  
 EAN 4000870 666678  
**666.67**

LED

**Window**

A++-A

incl. 3×5 W  
 3×381 lm, 3.000 K  
 230 V  
 ⌀90 ⇄485 ↻80 mm  
 EAN 4000870 666685  
**666.68**

LED

**Window**

A++-A

incl. 4×5 W  
 4×381 lm, 3.000 K  
 230 V  
 ⌀100 ⇄785 ↻90 mm  
 EAN 4000870 666692  
**666.69**

LED



⚙ Weiß matt/Chrom 🗪 Metall  
 ⚙ Blanc dépoli/Chrome 🗪 Métal  
 ⚙ Wit mat/Chroom 🗪 Metaal

**Frame**

A++-A

incl. 1×4,5 W  
 468 lm, 3.000 K  
 ✗ 110°  
 230 V  
 ⌀140 ⇄88 ↻131 mm  
 EAN 4000870 666388  
**666.38**

LED



On/Off

**Frame**

A++-A

incl. 2×4,5 W  
 2×468 lm, 3.000 K  
 ✗ 110°  
 230 V  
 ⌀131 ⇄280 ↻100 mm  
 EAN 4000870 666395  
**666.39**

LED

**Frame**

A++-A

incl. 3×4,5 W  
 3×468 lm, 3.000 K  
 ✗ 110°  
 230 V  
 ⌀131 ⇄430 ↻100 mm  
 EAN 4000870 666401  
**666.40**

LED

**Frame**

A++-A

incl. 4×4,5 W  
 4×468 lm, 3.000 K  
 ✗ 110°  
 230 V  
 ⌀131 ⇄250 ↻250 mm  
 EAN 4000870 666418  
**666.41**

LED





🌀 Weiß/Chrom 📏 Metall  
🌀 Blanc/Chrome 📏 Métal  
🌀 Wit/Chroom 📏 Metaal



**Launcher** ◀ A++-A

incl. 1×4,5 W  
 413 lm, 3.000 K  
 <math>\sphericalangle</math> 110°  
 230 V  
 ⤴140 ⤵80 ⤶98 mm  
 EAN 4000870 666340  
**666.34**

LED 📏 🕒 On/Off



**Launcher** ◀ A++-A

incl. 2×4,5 W  
 2×413 lm, 3.000 K  
 <math>\sphericalangle</math> 110°  
 230 V  
 ⤴98 ⤵280 ⤶80 mm  
 EAN 4000870 666357  
**666.35**

LED 📏



**Launcher** ◀ A++-A

incl. 3×4,5 W  
 3×413 lm, 3.000 K  
 <math>\sphericalangle</math> 110°  
 230 V  
 ⤴98 ⤵430 ⤶80 mm  
 EAN 4000870 666364  
**666.36**

LED 📏



**Launcher** ◀ A++-A

incl. 4×4,5 W  
 4×413 lm, 3.000 K  
 <math>\sphericalangle</math> 110°  
 230 V  
 ⤴98 ⤵250 ⤶250 mm  
 EAN 4000870 666371  
**666.37**

LED 📏



🌀 Chrom 📏 Metall/Acryl  
🌀 Chrome 📏 Métal/Acryl  
🌀 Chroom 📏 Metaal/Acryl



**Pole** ◀ A++-A

incl. 1×4,2 W  
 499 lm, 3.000 K  
 230 V  
 ⤴140 ⤵75 ⤶171 mm  
 EAN 4000870 666548  
**666.54**

LED 📏 🕒 On/Off



**Pole** ◀ A++-A

incl. 2×4,2 W  
 2×499 lm, 3.000 K  
 230 V  
 ⤴171 ⤵310 ⤶75 mm  
 EAN 4000870 666555  
**666.55**

LED 📏



**Pole** ◀ A++-A

incl. 3×4,2 W  
 3×499 lm, 3.000 K  
 230 V  
 ⤴171 ⤵444 ⤶75 mm  
 EAN 4000870 666562  
**666.56**

LED 📏



**Pole** ◀ A++-A

incl. 4×4,2 W  
 4×499 lm, 3.000 K  
 230 V  
 ⤴171 ⤵282 ⤶282 mm  
 EAN 4000870 666579  
**666.57**

LED 📏



⚙ Chrom ⏏ Metall  
 ⚙ Chrome ⏏ Métal  
 ⚙ Chroom ⏏ Metaal

**Egg LED**

A++-A

incl. 1×4,2 W  
 490 lm, 2.700 K  
 230 V  
 ⌀148 ⇄100 ⌀100 mm  
 EAN 4000870 603284  
**603.28**

LED

**Egg LED**

A++-A

incl. 2×4,2 W  
 2×490 lm, 2.700 K  
 230 V  
 ⌀170 ⇄320 ⌀100 mm  
 EAN 4000870 603291  
**603.29**

LED

**Egg LED**

A++-A

incl. 3×4,2 W  
 3×490 lm, 2.700 K  
 230 V  
 ⌀170 ⇄530 ⌀100 mm  
 EAN 4000870 603307  
**603.30**

LED

**Egg LED**

A++-A

incl. 4×4,2 W  
 4×490 lm, 2.700 K  
 230 V  
 ⌀170 ⇄674 ⌀100 mm  
 EAN 4000870 603314  
**603.31**

LED



⚙ Nickel ⏏ Metall  
 ⚙ Nickel ⏏ Métal  
 ⚙ Nikkel ⏏ Metaal

**Tumbler**

A++-A

incl. 1×4,5 W  
 318 lm, 3.000 K  
 230 V  
 ⌀130 ⇄152 ⌀80 mm  
 EAN 4000870 666586  
**666.58**

LED

**Tumbler**

A++-A

incl. 2×4,5 W  
 2×318 lm, 3.000 K  
 230 V  
 ⌀146 ⇄303 ⌀85 mm  
 EAN 4000870 666593  
**666.59**

LED

**Tumbler**

A++-A

incl. 3×4,5 W  
 3×318 lm, 3.000 K  
 230 V  
 ⌀146 ⇄505 ⌀85 mm  
 EAN 4000870 666609  
**666.60**

LED

**Tumbler**

A++-A

incl. 4×4,5 W  
 4×318 lm, 3.000 K  
 230 V  
 ⌀146 ⇄731 ⌀100 mm  
 EAN 4000870 666616  
**666.61**

LED

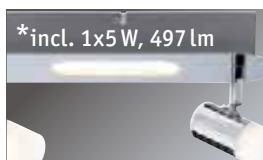

🔗 Chrom 📏 Metall  
🔗 Chrome 📏 Métal  
🔗 Chrom 📏 Metaal

⚡ 283.38  
 284.46

**Lagoon**

max. 10 W, G9  
 230 V  
 ⚡104 ⚡100 ⚡104 mm  
 EAN 4000870 666463  
**666.46**

A++-E



**Lagoon**

\* max. 2×10 W, G9  
 2×497 lm, 3.000 K  
 230 V  
 ⚡75 ⚡350 ⚡150 mm  
 EAN 4000870 666470  
**666.47**

LED



**Lagoon**

\* max. 3×10 W, G9  
 3×497 lm, 3.000 K  
 230 V  
 ⚡75 ⚡845 ⚡155 mm  
 EAN 4000870 666494  
**666.49**

LED



**Lagoon**

\* max. 4×10 W, G9  
 4×497 lm, 3.000 K  
 230 V  
 ⚡115 ⚡290 mm  
 EAN 4000870 666487  
**666.48**

LED







⚡ Weiß/Chrom 📦 Metall  
 ⚡ Blanc/Chrome 📦 Métal  
 ⚡ Wit/Chroom 📦 Metaal

⚡ 282.99  
 283.00



**Zyli IP44** ⚡ A++-E  
 max. 10 W, GU10  
 230 V  
 ø100 ↗110 mm  
 EAN 4000870 667101  
**667.10**

**Zyli IP44** ⚡ A++-E  
 max. 2×10 W, GU10  
 230 V  
 ⚡110 ⇄400 ↗70 mm  
 EAN 4000870 667118  
**667.11**

**Zyli IP44** ⚡ A++-E  
 max. 3×10 W, GU10  
 230 V  
 ⚡110 ⇄600 ↗70 mm  
 EAN 4000870 667132  
**667.13**

**Zyli IP44** ⚡ A++-E  
 max. 3×10 W, GU10  
 230 V  
 ⚡110 ø250 mm  
 EAN 4000870 667125  
**667.12**



⚡ Weiß/Chrom 📦 Metall  
 ⚡ Blanc/Chrome 📦 Métal  
 ⚡ Wit/Chroom 📦 Metaal

⚡ 282.99  
 283.00



**Tube IP44** ⚡ A++-E  
 max. 10 W, GU10  
 230 V  
 ⚡138 ø100 ↗94 mm  
 EAN 4000870 667170  
**667.17**

**Tube IP44** ⚡ A++-E  
 max. 2×10 W, GU10  
 230 V  
 ⚡94 ⇄350 ↗65 mm  
 EAN 4000870 667187  
**667.18**

**Tube IP44** ⚡ A++-E  
 max. 3×10 W, GU10  
 230 V  
 ⚡94 ø250 mm  
 EAN 4000870 667194  
**667.19**



⚡ Weiß/Chrom 📦 Metall  
 ⚡ Blanc/Chrome 📦 Métal  
 ⚡ Wit/Chroom 📦 Metaal

⚡ 282.99  
 283.00



**Drop IP44** ⚡ A++-E  
 max. 10 W, GU10  
 230 V  
 ⚡123 ø100 ↗165 mm  
 EAN 4000870 667149  
**667.14**

**Drop IP44** ⚡ A++-E  
 max. 2×10 W, GU10  
 230 V  
 ⚡165 ⇄350 ↗65 mm  
 EAN 4000870 667156  
**667.15**

**Drop IP44** ⚡ A++-E  
 max. 3×10 W, GU10  
 230 V  
 ⚡165 ø250 mm  
 EAN 4000870 667163  
**667.16**



⚙️ Weiß/Chrom 🗄️ Metall/Kunststoff  
 ⚙️ Blanc/Chrome 🗄️ Métal/Matière plastique  
 ⚙️ Wit/Chroom 🗄️ Metaal/Kunststof

- 💡 283.00
- 284.34
- 500.14
- 500.15
- 500.21



**Turn** A++-E  
 max. 10 W, GU10  
 230 V  
 ⚙️ 140 ⇄ 98 ↻ 150 mm  
 EAN 4000870 666746  
**666.74**

**Turn** A++-E  
 max. 2×10 W, GU10  
 230 V  
 ⚙️ 140 ⇄ 400 ↻ 98 mm  
 EAN 4000870 666753  
**666.75**

**Turn** A++-E  
 max. 4×10 W, GU10  
 230 V  
 ⚙️ 140 ⇄ 680 ↻ 98 mm  
 EAN 4000870 666760  
**666.76**



⚡ Schwarz/Chrom 🗄 Metall/Kunststoff  
 ⚡ Noir/Chrome 🗄 Métal/Matière plastique  
 ⚡ Zwart/Chroom 🗄 Metaal/Kunststof

⚡ 283.00  
 284.34  
 500.14  
 500.15  
 500.21

**Turn** A++-E

max. 10 W, GU10  
 230 V  
 ⚡140 ⇄98 ⚡150 mm  
 EAN 4000870 666708  
**666.70**

**Turn** A++-E

max. 2×10 W, GU10  
 230 V  
 ⚡140 ⇄400 ⚡98 mm  
 EAN 4000870 666715  
**666.71**

**Turn** A++-E

max. 4×10 W, GU10  
 230 V  
 ⚡140 ⇄680 ⚡98 mm  
 EAN 4000870 666722  
**666.72**



⚡ Chrom matt/Opal 🗄 Metall/Glas  
 ⚡ Chrome mat/Opale 🗄 Métal/Verre  
 ⚡ Chroom mat/Opaal 🗄 Metaal/Glas

⚡ 282.86  
 284.34

**WolbaLED** A++-E

max. 10 W, GU10  
 230 V  
 ⚡105 ⇄100 ⚡105 mm  
 EAN 4000870 666821  
**666.82**

**WolbaLED** A++-E

max. 2×10 W, GU10  
 230 V  
 ⚡105 ⇄275 ⚡60 mm  
 EAN 4000870 666838  
**666.83**

**WolbaLED** A++-E

max. 4×10 W, GU10  
 230 V  
 ⚡105 ⇄210 ⚡210 mm  
 EAN 4000870 666845  
**666.84**

**WolbaLED** A++-E

max. 6×10 W, GU10  
 230 V  
 ⚡170 ⇄1.660 ⚡55 mm  
 EAN 4000870 666852  
**666.85**





⚡ Chrom/Satin ⏏ Metall/Glas  
 ⚡ Chrome/Satiné ⏏ Métal/Verre  
 ⚡ Chroom/Satijn ⏏ Metaal/Glas

💡 284.46



**Yasmin** ⏏ A++-E

max. 10 W, G9  
 230 V  
 ø80 ↗155 mm  
 EAN 4000870 666906  
**666.90**



**Yasmin** ⏏ A++-E

max. 3×10 W, G9  
 230 V  
 ⚡140 ø280 mm  
 EAN 4000870 666913  
**666.91**

**Yasmin** ⏏ A++-E

max. 4×10 W, G9  
 230 V  
 ⚡145 ⇄715 ↗100 mm  
 EAN 4000870 666920  
**666.92**



⚡ Chrom ⏏ Metall  
 ⚡ Chrome ⏏ Métal  
 ⚡ Chroom ⏏ Metaal

💡 283.00  
 284.34  
 500.14  
 500.15  
 500.21



**Rondo** ⏏ A++-E

max. 10 W, GU10  
 230 V  
 ⚡105 ⇄100 ↗120 mm  
 EAN 4000870 666784  
**666.78**



**Rondo** ⏏ A++-E

max. 2×10 W, GU10  
 230 V  
 ⚡120 ⇄260 ↗75 mm  
 EAN 4000870 666791  
**666.79**

**Rondo** ⏏ A++-E

max. 3×10 W, GU10  
 230 V  
 ⚡120 ⇄420 ↗75 mm  
 EAN 4000870 666807  
**666.80**

**Rondo** ⏏ A++-E

max. 4×10 W, GU10  
 230 V  
 ⚡120 ø220 mm  
 EAN 4000870 666814  
**666.81**



⚡ Nickel satiniert Metall  
 ⚡ Nickel satiné Métal  
 ⚡ Nikkel gesatineerd Metaal

⚡ 283.00  
 ⚡ 284.34  
 ⚡ 500.14  
 ⚡ 500.15  
 ⚡ 500.21



**Meli** A++-E  
 max. 10 W, GU10  
 230 V  
 ⚡100 ⇄100 ⚡160 mm  
 EAN 4000870 666869  
**666.86**

**Meli** A++-E  
 max. 2×10 W, GU10  
 230 V  
 ⚡160 ⇄260 ⚡55 mm  
 EAN 4000870 666876  
**666.87**

**Meli** A++-E  
 max. 3×10 W, GU10  
 230 V  
 ⚡160 ⇄400 ⚡55 mm  
 EAN 4000870 666883  
**666.88**

**Meli** A++-E  
 max. 4×10 W, GU10  
 230 V  
 ⚡160 ⇄600 ⚡55 mm  
 EAN 4000870 666890  
**666.89**



⚡ Chrom Metall  
 ⚡ Chrome Métal  
 ⚡ Chroom Metaal

⚡ 283.00  
 ⚡ 284.34  
 ⚡ 500.14  
 ⚡ 500.15  
 ⚡ 500.21



**Zylo** A++-E  
 max. 10 W, GU10  
 230 V  
 ⚡100 ⇄100 ⚡132 mm  
 EAN 4000870 666937  
**666.93**

**Zylo** A++-E  
 max. 2×10 W, GU10  
 230 V  
 ⚡132 ⇄260 ⚡55 mm  
 EAN 4000870 666944  
**666.94**

**Zylo** A++-E  
 max. 3×10 W, GU10  
 230 V  
 ⚡132 ⇄400 ⚡55 mm  
 EAN 4000870 666951  
**666.95**

**Zylo** A++-E  
 max. 4×10 W, GU10  
 230 V  
 ⚡132 ⇄695 ⚡70 mm  
 EAN 4000870 666968  
**666.96**



Nickel gebürstet Metall  
 Nickel brossé Métal  
 Nikkel geborsteld Metaal

284.10  
 284.34  
 500.14  
 500.15  
 500.21

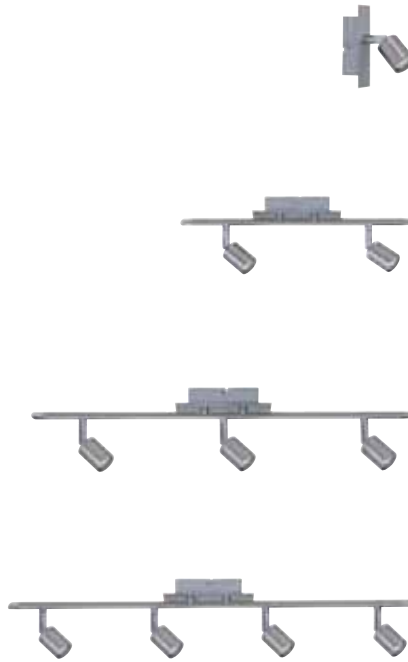

**Georgia** A++-E

max. 10 W, GU10  
 230 V  
 ⌀125 ⇄55 ⌀75 mm  
 EAN 4000870 667064  
**667.06**

**Georgia** A++-E

max. 2×10 W, GU10  
 230 V  
 ⌀100 ⇄396 ⌀55 mm  
 EAN 4000870 667071  
**667.07**

**Georgia** A++-E

max. 3×10 W, GU10  
 230 V  
 ⌀100 ⇄600 ⌀55 mm  
 EAN 4000870 667088  
**667.08**

**Georgia** A++-E

max. 4×10 W, GU10  
 230 V  
 ⌀100 ⇄675 ⌀55 mm  
 EAN 4000870 667095  
**667.09**



Nickel satiniert Metall  
 Nickel satiné Métal  
 Nikkel gesatineerd Metaal

284.10  
 284.34  
 500.14  
 500.15  
 500.21



**Teja** A++-E

max. 10 W, GU10  
 230 V  
 ⌀100 ⇄52 ⌀120 mm  
 EAN 4000870 666982  
**666.98**

**Teja** A++-E

max. 2×10 W, GU10  
 230 V  
 ⌀120 ⇄308 ⌀52 mm  
 EAN 4000870 666999  
**666.99**

**Teja** A++-E

max. 3×10 W, GU10  
 230 V  
 ⌀120 ⇄500 ⌀52 mm  
 EAN 4000870 667002  
**667.00**

**Teja** A++-E

max. 4×10 W, GU10  
 230 V  
 ⌀120 ⇄250 ⌀250 mm  
 EAN 4000870 667019  
**667.01**

**Teja Flex** A++-E

max. 10 W, GU10  
 230 V  
 ⌀100 ⇄52 ⌀350 mm  
 EAN 4000870 666975  
**666.97**



Wei Metall  
Blanc Mtal  
Wit Metaal

284.10  
284.34  
500.14  
500.15  
500.21



#### Teja

max. 10 W, GU10  
230 V  
100 ⇄ 52 120 mm  
EAN 4000870 667026  
**667.02**

A++-E



#### Teja

max. 2×10 W, GU10  
230 V  
120 ⇄ 308 52 mm  
EAN 4000870 667033  
**667.03**

A++-E

#### Teja

max. 3×10 W, GU10  
230 V  
120 ⇄ 500 52 mm  
EAN 4000870 667040  
**667.04**

A++-E

#### Teja

max. 4×10 W, GU10  
230 V  
120 ⇄ 250 250 mm  
EAN 4000870 667057  
**667.05**

A++-E



Nickel gebstet Metall/Glas  
Nickel bross Mtal/Verre  
Nikkel geborsteld Metaal/Glas

283.38



#### Helix

incl. 1×2,2 W, G9, A+  
200 lm, 2.700 K  
230 V  
127 90 110 mm  
EAN 4000870 601983  
**601.98**

A++-E

LED



#### Helix

incl. 2×2,2 W, G9, A+  
2×200 lm, 2.700 K  
230 V  
130 ⇄ 365 90 mm  
EAN 4000870 601990  
**601.99**

A++-E

LED



#### Helix

incl. 3×2,2 W, G9, A+  
3×200 lm, 2.700 K  
230 V  
135 ⇄ 525 90 mm  
EAN 4000870 602003  
**602.00**

A++-E

LED



#### Helix

incl. 4×2,2 W, G9, A+  
4×200 lm, 2.700 K  
230 V  
120 220 mm  
EAN 4000870 601624  
**601.62**

A++-E

LED





⚙ Weiß/Chrom   Metall  
 ⚙ Blanc/Chrome   Métal  
 ⚙ Wit/Chroom   Metaal

⚡ 283.38  
 284.46

**LED Double**

A++-E

incl. 1x2,2 W, G9, A++  
 200 lm, 2.700 K  
 230 V  
 ⚡108 ⇄100 ↻100 mm  
 EAN 4000870 666180  
**666.18**

LED



On/Off

**LED Double**

A++-E

incl. 2x2,2 W, G9, A++  
 2x200 lm, 2.700 K  
 230 V  
 ⚡118 ⇄364 ↻100 mm  
 EAN 4000870 666197  
**666.19**

LED

**LED Double**

A++-E

incl. 3x2,2 W, G9, A++  
 3x200 lm, 2.700 K  
 230 V  
 ⚡118 ⇄604 ↻100 mm  
 EAN 4000870 666203  
**666.20**

LED

**LED Double**

A++-E

incl. 4x2,2 W, G9, A++  
 4x200 lm, 2.700 K  
 230 V  
 ⚡118 ⇄704 ↻100 mm  
 EAN 4000870 666210  
**666.21**

LED



⚙ Eisen gebürstet   Metall/Kunststoff  
 ⚙ Acier brossé   Métal/Matière plastique  
 ⚙ Staal geborsteld   Metaal/Kunststof

**Cubik**

A++-A

incl. 1x4 W  
 362 lm, 3.000 K  
 230 V  
 ⚡130 ø80 mm  
 EAN 4000870 667361  
**667.36 new**

LED

**Cubik**

A++-A

incl. 2x4 W  
 2x362 lm, 3.000 K  
 230 V  
 ⚡140 ⇄300 ↻80 mm  
 EAN 4000870 667378  
**667.37 new**

LED

**Cubik**

A++-A

incl. 4x4 W  
 4x362 lm, 3.000 K  
 230 V  
 ⚡145 ⇄780 ↻90 mm  
 EAN 4000870 667385  
**667.38 new**

LED





- 🔗 Grau 📦 Metall/Beton
- 🔗 Gris 📦 Métal/Béton
- 🔗 Grijs 📦 Metaal/Beton

💡 282.99



#### Ogma

◀ A++-E

max. 10 W, GU10  
230 V  
⌀110 ⇄100 ⌀143 mm  
EAN 4000870 667392  
**667.39 new**



#### Ogma

◀ A++-E

max. 2×10 W, GU10  
230 V  
⌀143 ø168 mm  
EAN 4000870 667408  
**667.40 new**



#### Ogma

◀ A++-E

max. 3×10 W, GU10  
230 V  
⌀143 ø230 mm  
EAN 4000870 667415  
**667.41 new**



- ⌘ Schwarzchrom/Chrom ⌘ Metall
- ⌘ Chrome noir/Chrome ⌘ Métal
- ⌘ Black chrom/Chroom ⌘ Metaal



**Funnel** A++-A  
 incl. 1×6 W  
 540 lm, 3.000 K  
 230 V  
 ⌀145 ø100 mm  
 EAN 4000870 667286  
**667.28 new**



**Funnel** A++-A  
 incl. 2×6 W  
 2×540 lm, 3.000 K  
 230 V  
 ⌀150 ⇔280 ⌀80 mm  
 EAN 4000870 667293  
**667.29 new**



**Funnel** A++-A  
 incl. 3×6 W  
 3×540 lm, 3.000 K  
 230 V  
 ⌀150 ø240 mm  
 EAN 4000870 667309  
**667.30 new**



**Funnel** A++-A  
 incl. 4×6 W  
 4×540 lm, 3.000 K  
 230 V  
 ⌀185 ⇔840 ⌀80 mm  
 EAN 4000870 667316  
**667.31 new**



- ⌘ Weiß matt/Chrom ⌘ Metall
- ⌘ Blanc dépoli/Chrome ⌘ Métal
- ⌘ Wit mat/Chroom ⌘ Metaal



**Funnel** A++-A  
 incl. 1×6 W  
 540 lm, 3.000 K  
 230 V  
 ⌀145 ø100 mm  
 EAN 4000870 667323  
**667.32 new**



**Funnel** A++-A  
 incl. 2×6 W  
 2×540 lm, 3.000 K  
 230 V  
 ⌀150 ⇔280 ⌀80 mm  
 EAN 4000870 667330  
**667.33 new**



**Funnel** A++-A  
 incl. 3×6 W  
 3×540 lm, 3.000 K  
 230 V  
 ⌀150 ø240 mm  
 EAN 4000870 667347  
**667.34 new**



**Funnel** A++-A  
 incl. 4×6 W  
 4×540 lm, 3.000 K  
 230 V  
 ⌀185 ⇔840 ⌀80 mm  
 EAN 4000870 667354  
**667.35 new**





⚙ Chrom Metall/Kunststoff  
 ⚙ Chrome Métal/Matière plastique  
 ⚙ Chroom Metaal/Kunststof



not incl.  
 Remote Control  
 □= 400

Bluetooth®



#### Porto

A++-A

incl. 1×4,5 W  
 500 lm, 3.000 K  
 230 V  
 ⌀160 ⌀100 mm  
 EAN 4000870 500743  
**500.74 new**

LED



#### Porto

A++-A

incl. 3×4,5 W  
 3×500 lm, 3.000 K  
 230 V  
 ⌀189 ⇄564 ⌀100 mm  
 EAN 4000870 500750  
**500.75 new**

LED



⚙ Chrom Metall/Kunststoff  
 ⚙ Chrome Métal/Matière plastique  
 ⚙ Chroom Metaal/Kunststof



not incl.  
 Remote Control  
 □= 400

Bluetooth®



#### Lisboa

A++-A

incl. 1×4,5 W  
 380 lm, 3.000 K  
 230 V  
 ⌀160 ⌀140 mm  
 EAN 4000870 500781  
**500.78 new**

LED



#### Lisboa

A++-A

incl. 3×4,5 W  
 3×380 lm, 3.000 K  
 230 V  
 ⌀194 ⇄604 ⌀80 mm  
 EAN 4000870 500798  
**500.79 new**

LED





⚡ Chrom Metall/Kunststoff  
 ⚡ Chrome Métal/Matière plastique  
 ⚡ Chroom Metaal/Kunststof



not incl.  
Remote Control

= 400

**Bluetooth**



**Coimbra**

A++-A

incl. 1×4,5 W  
400 lm, 3.000 - 6.500 K  
230 V  
⌀150 ø100 mm  
EAN 4000870 500767  
**500.76 new**



**Coimbra**

A++-A

incl. 3×4,5 W  
3×400 lm, 3.000 - 6.500 K  
230 V  
⌀150 ø220 mm  
EAN 4000870 500774  
**500.77 new**



⚡ Chrom Metall/Kunststoff  
 ⚡ Chrome Métal/Matière plastique  
 ⚡ Chroom Metaal/Kunststof



not incl.  
Remote Control

= 402

**ZigBee**



**Zala**

A++-A

incl. 1×6 W  
500 lm, 3.000 K  
230 V  
⌀125 ø130 mm  
EAN 4000870 500965  
**500.96 new**

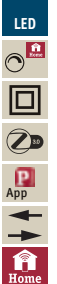

**Zala**

A++-A

incl. 3×6 W  
3×500 lm, 3.000 K  
230 V  
⌀150 ø310 mm  
EAN 4000870 500972  
**500.97 new**

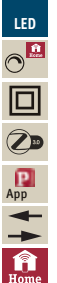



⚡ Schwarzchrom Metall/Kunststoff  
 ⚡ Chrome noir Métal/Matière plastique  
 ⚡ Black chrom Metaal/Kunststof



not incl.  
**Remote Control**  
 □= 402

**Deon**

A++-A

incl. 1×6,5 W  
 600 lm, 3.000 - 6.500 K  
 230 V  
 ⌀160 ⇄100 ⚙142 mm  
 EAN 4000870 500989  
**500.98 new**

LED

**Deon**

A++-A

incl. 3×6,5 W  
 3×600 lm, 3.000 - 6.500 K  
 230 V  
 ⌀132 ⇄500 ⚙75 mm  
 EAN 4000870 500996  
**500.99 new**

LED



⚡ Chrom Metall/Kunststoff  
 ⚡ Chrome Métal/Matière plastique  
 ⚡ Chroom Metaal/Kunststof



not incl.  
**Remote Control**  
 □= 402

**Iro**

A++-A

incl. 1×7 W  
 600 lm, 3.000 K  
 230 V  
 ⌀144 ⌀130 mm  
 EAN 4000870 501009  
**501.00 new**

LED

**Iro**

A++-A

incl. 3×7 W  
 3×600 lm, 3.000 K  
 230 V  
 ⌀144 ⌀240 mm  
 EAN 4000870 501016  
**501.01 new**

LED

# Wire Systems

- 126 LED 24V DC
- 129 LED 12V DC
- 135 LED AC

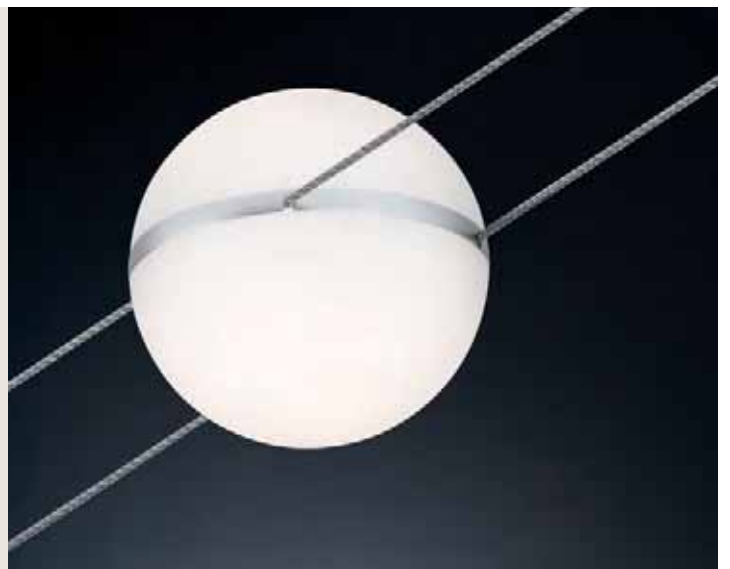

126 2Line Spot Tom



129 RoundMac





### 2Line : Innovatives und filigranes Lichtsystem

2Line ist die nächste Generation der Seil-Lichtsysteme im zeitlos-eleganten Paulmann Design. Auf den filigranen Seilen scheinen die Spots im Raum zu schweben – diese Weltneuheit stellt klassische Seilsysteme in den Schatten.

Cleveres Montagesystem: Die Basic Sets enthalten eine Befestigung mit Kugelgelenk und ermöglichen dadurch eine deutlich einfachere Montage. Dank 24-Volt-Gleichspannung besteht höchste Sicherheit für den Anwender.

Get smart: Die 2Line Basic Sets sind auch als aktuelle Bluetooth Smart Home Version erhältlich!

### 2Line : système d'éclairage innovant et fin

2Line est la nouvelle génération des systèmes d'éclairage sur câble au design élégant et intemporel Paulmann. Les spots semblent flotter sur les câbles fins - cette nouveauté mondiale relègue dans l'ombre les systèmes câbles classiques.

Système de montage intelligent : Les Basic Sets comprennent une fixation avec rotule qui facilite ainsi sensiblement la pose. Le courant continu 24 V confère la plus haute sécurité pour l'utilisateur.

Get smart : Les Basic Sets 2Line sont aussi disponibles en version moderne Smart Home Bluetooth.

### 2Line: innovatief en filigraan lichtstelsysteem

2Line is de volgende generatie van kabellichtsystemen in een tijdloos elegant Paulmann design. Op de filigraankabels lijken de spots in de ruimte te zweven. Deze wereldprimeur doet de klassieke kabelsystemen naar de achtergrond verdwijnen.

Slim montagesysteem: De Basic Sets zijn uitgerust met een kogelgewricht als bevestiging, waardoor de montage aanzienlijk eenvoudiger wordt. Dankzij de 24 volt gelijkspanning bestaat voor de gebruiker maximale veiligheid.

Get smart: De 2Line Basic Sets zijn ook als moderne Bluetooth Smart Home variant verkrijgbaar!



230V  $\rightarrow$  Trafo  $\rightarrow$  24V  $\text{---}$  DC



not incl.  
Remote Control  
 $\square$  = 400

Bluetooth®

**2Line BLE Basic Set**

A++-E

max. 36 W  
230/24 V, incl.  $\text{---}$  36 VA  
 $\pm$  55 mm  $\leftrightarrow$  12 m  
EAN 4000870 941621  
**941.62 new**



- Weiß/Chrom matt  $\square$  Metall
- Blanc/Chrome mat  $\square$  Métal
- Wit/Chroom mat  $\square$  Metaal

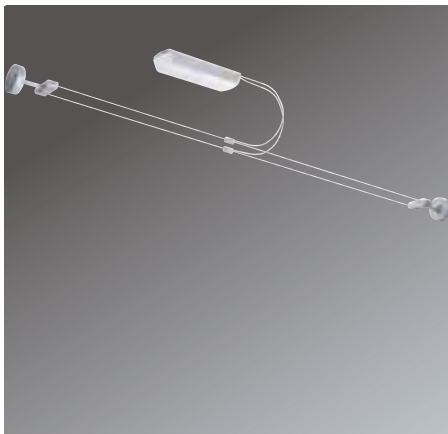

230V  $\rightarrow$  Trafo  $\rightarrow$  24V  $\text{---}$  DC



**2Line Basic Set**

A++-E

max. 30 W  
230/24 V, incl.  $\text{---}$  30 VA  
 $\pm$  55 mm  $\leftrightarrow$  12 m  
EAN 4000870 941614  
**941.61 new**



- Weiß/Chrom matt  $\square$  Metall
- Blanc/Chrome mat  $\square$  Métal
- Wit/Chroom mat  $\square$  Metaal

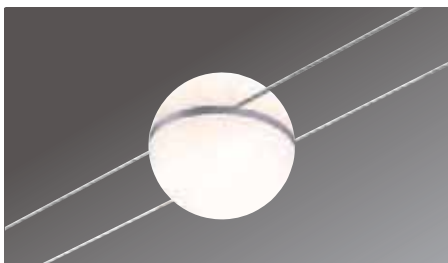

**Spot Tom**

A++-A

incl. 1x3,6 W  
470 lm, 2.700 K  
DC 24 V  
 $\pm$  55  $\varnothing$  92 mm  
EAN 4000870 940839

**940.83 new**

- Weiß/Chrom  $\square$  Kunststoff/Metall
- Blanc/Chrome  $\square$  Matière plastique/Métal
- Wit/Chroom  $\square$  Kunststof/Metaal

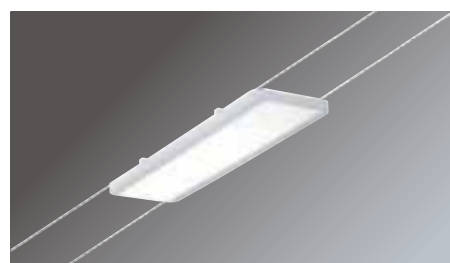

**Spot Lenny**

A++-A

incl. 1x4,6 W  
700 lm, 2.700 K  
DC 24 V  
 $\pm$  55  $\updownarrow$  12  $\leftrightarrow$  260  $\varnothing$  70 mm  
EAN 4000870 941638

**941.63 new**

- Weiß  $\square$  Kunststoff/Metall
- Blanc  $\square$  Matière plastique/Métal
- Wit  $\square$  Kunststof/Metaal



**Spot Luke**

A++-A

incl. 3x1,8 W  
3x220 lm, 2.700 K  
DC 24 V  
 $\pm$  55  $\updownarrow$  30  $\leftrightarrow$  260  $\varnothing$  70 mm  
EAN 4000870 941645

**941.64 new**

- Weiß  $\square$  Kunststoff/Metall
- Blanc  $\square$  Matière plastique/Métal
- Wit  $\square$  Kunststof/Metaal



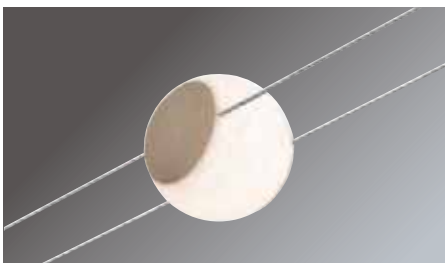

**Spot Lynn**

A++-A

incl. 1x4,5 W  
450 lm, 2.700 K  
DC 24 V  
∅92 mm  
EAN 4000870 941584

**941.58 new**

- 🌀 Eiche hell/Weiß 🗪 Kunststoff
- 🌀 Eiche hell/Blanc 🗪 Matière plastique
- 🌀 Eiche hell/Wit 🗪 Kunststof

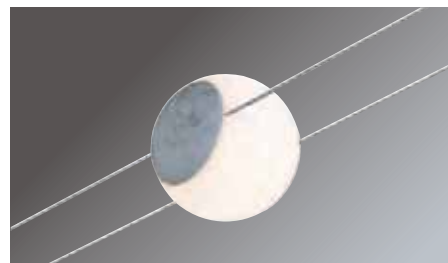
**Spot Emma**

A++-A

incl. 1x4,5 W  
450 lm, 2.700 K  
DC 24 V  
∅92 mm  
EAN 4000870 941591

**941.59 new**

- 🌀 Beton/Weiß 🗪 Kunststoff
- 🌀 Béton/Blanc 🗪 Matière plastique
- 🌀 Beton/Wit 🗪 Kunststof

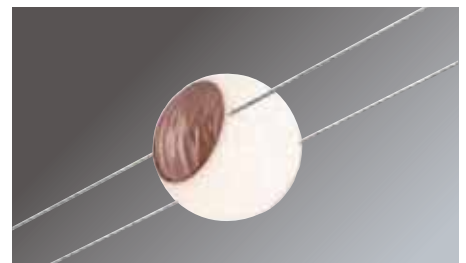
**Spot Mary**

A++-A

incl. 1x4,5 W  
450 lm, 2.700 K  
DC 24 V  
∅92 mm  
EAN 4000870 941607

**941.60 new**

- 🌀 Kupfer Struktur/Weiß 🗪 Kunststoff
- 🌀 Kupfer Struktur/Blanc 🗪 Matière plastique
- 🌀 Kupfer Struktur/Wit 🗪 Kunststof



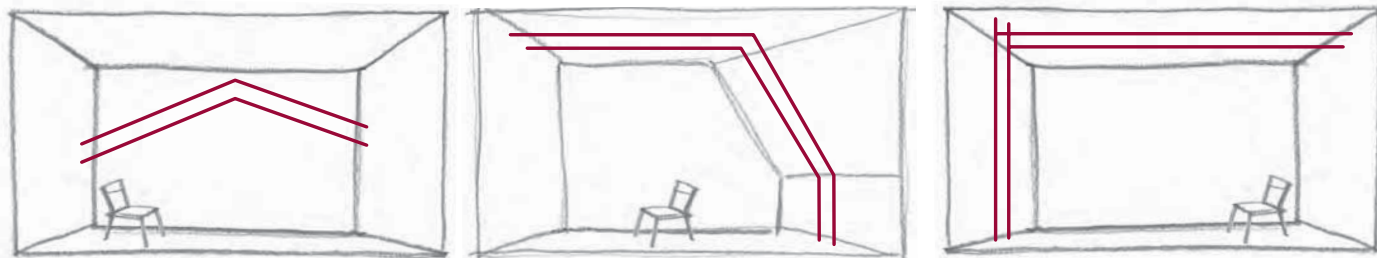

Seilsysteme sind eine flexible Lösung, um die eigenen vier Wände ins rechte Licht zu rücken. Die Verlegung der stromführenden Seile ist problemlos möglich und aufgrund der modernen 12 V Technologie sicherer und deutlich einfacher als bei herkömmlichen 230 V Installationen. Auch bei schwierigen räumlichen Situationen (z. B. schräge Decken oder Über-Eck-Verbindungen) bieten Seilsysteme ideale Lichtlösungen an. Bei der Nutzung von Umlenkern (zusätzlich erhältlich) können auch komplette Wohnbereiche mit nur einer einzigen Installation umfassend ausgeleuchtet werden. Mit über 30 verschiedenen Komplett-Sets wird jedem Einrichtungsgeschmack Rechnung getragen. Die Vielfalt der erhältlichen Leuchten bietet für jeden Anspruch die richtige Lösung: Gerichtetes Licht zur individuellen Objektbeleuchtung ist genauso möglich wie weiche Lichtverteilung für eine gleichmäßige Grundausleuchtung.

Les systèmes câbles offrent une solution flexible pour mettre votre intérieur en valeur. Vous pouvez installer sans problème les câbles conducteurs, cette technologie moderne 12 V garantissant en outre une pose plus sûre et beaucoup plus facile que celle des installations 230 V traditionnelles. Même dans les espaces difficiles (p. ex. plafonds mansardés ou raccords d'angles), les systèmes câbles offrent des solutions d'éclairage idéales. Ainsi, les renvois d'angle (disponibles en supplément) peuvent éclairer des pièces à vivre entières à partir d'une seule installation. Riche de plus de 30 kits différents, la gamme répond à tous les besoins d'éclairage. La diversité des luminaires disponibles offre la solution adéquate pour répondre à toutes les exigences. Une lumière précisément dirigée sur un objet est également possible, de même qu'une douce répartition lumineuse pour un éclairage de base homogène.

Kabelsystemen zijn een flexibele oplossing om de eigen vier muren in het juiste licht te plaatsen. Het leggen van de stroomvoerende kabel is probleemloos mogelijk en dankzij de moderne 12V-technologie veiliger en aanzienlijk eenvoudiger dan bij traditionele 230V-installaties. Ook in moeilijke ruimtelijke situaties (bijv. bij schuine plafonds of overhoekse verbindingen) bieden kabelsystemen ideale verlichtingsoplossingen. Bij het gebruik van afbuigelementen (apart verkrijgbaar) kunnen ook complete woonruimtes met één enkele installatie uitgebreid worden verlicht. Met meer dan 30 verschillende complete sets wordt rekening gehouden met elke interieurstijl. Het uitgebreide aanbod aan verkrijgbare lampen heeft voor elke smaak de juiste oplossing: gericht licht om voorwerpen individueel te verlichten of een zachte lichtverdeling voor een egale basisverlichting. Alles is mogelijk!

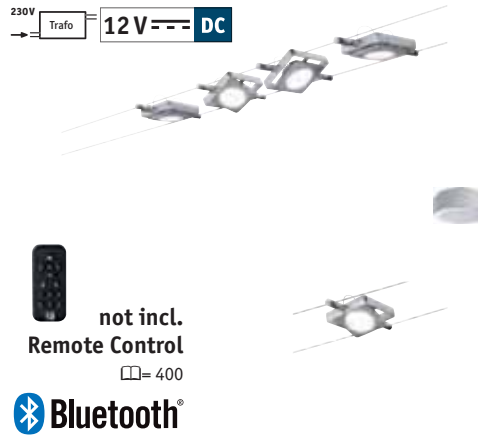

**Set MacLED**

incl. 4x4 W  
4x320 + 440 lm, 2.700 - 6.500 K  
230/12V, incl. 36 VA  
160 mm 2,5 mm<sup>2</sup> ⇔ 10 m  
EAN 4000870 501085  
**501.08 new**



not incl.  
**Remote Control**  
□ = 400  
Bluetooth®

**Spot MacLED**

incl. 1x4 W  
320 + 440 lm, 2.700 - 6.500 K  
12 V  
160 24 ⇔ 92 92 mm  
EAN 4000870 501122  
**501.12 new**

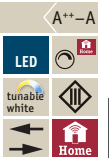

- ☞ Chrom matt Metall/Kunststoff
- ☞ Chrome mat Métal/Matière plastique
- ☞ Chrom matt Metaal/Kunststof

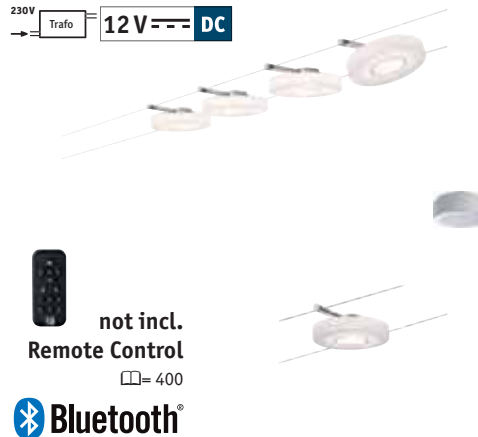

**Set DiscLED I**

incl. 4x4 W  
4x320 + 440 lm, 2.700 - 6.500 K  
230/12V, incl. 36 VA  
160 mm 2,5 mm<sup>2</sup> ⇔ 10 m  
EAN 4000870 501092  
**501.09 new**



not incl.  
**Remote Control**  
□ = 400  
Bluetooth®

**Spot DiscLED I**

incl. 1x4 W  
320 + 440 lm, 2.700 - 6.500 K  
12 V  
160 37 ø130 mm  
EAN 4000870 501139  
**501.13 new**



- ☞ Satin Metall/Kunststoff
- ☞ Satiné Métal/Matière plastique
- ☞ Satijn Metaal/Kunststof

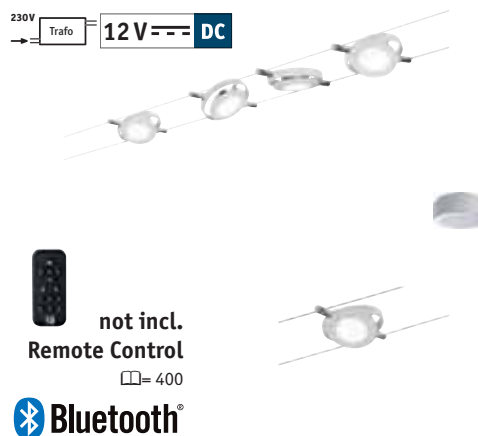

**Set RoundMac**

incl. 4x4 W  
4x320 + 440 lm, 2.700 - 6.500 K  
230/12V, incl. 36 VA  
160 mm 2,5 mm<sup>2</sup> ⇔ 10 m  
EAN 4000870 501078  
**501.07 new**



not incl.  
**Remote Control**  
□ = 400  
Bluetooth®

**Spot RoundMac**

incl. 1x4 W  
320 + 440 lm, 2.700 - 6.500 K  
12 V  
160 24 ø102 mm  
EAN 4000870 501115  
**501.11 new**



- ☞ Weiß matt Metall/Kunststoff
- ☞ Blanc dépoli Métal/Matière plastique
- ☞ Wit mat Metaal/Kunststof

**Set DiscLED II**

incl. 4×4 W  
4×320 + 440 lm, 2.700 - 6.500 K  
230/12 V, incl. 36 VA  
160 mm 2,5 mm<sup>2</sup> ⇔ 10 m  
EAN 4000870 501108  
**501.10 new**



not incl.  
**Remote Control**  
□ = 400  
 **Bluetooth®**

**Spot DiscLED II**

incl. 1×4 W  
320 + 440 lm, 2.700 - 6.500 K  
12 V  
160 mm 2,5 mm<sup>2</sup> ⇔ 10 m  
EAN 4000870 501146  
**501.14 new**



- Transparent Metall/Kunststoff
- Transparent Métal/Matière plastique
- Transarant Metaal/Kunststof

**Set IceLED**

incl. 4×4 W  
4×320 + 440 lm, 2.700 - 6.500 K  
230/12 V, incl. 36 VA  
160 mm 2,5 mm<sup>2</sup> ⇔ 10 m  
EAN 4000870 500163  
**500.16**



not incl.  
**Remote Control**  
□ = 400  
 **Bluetooth®**

- Chrom matt/Weiß Metall
- Chrome mat/Blanc Métal
- Chroom mat/Wit Metaal

**Set Basic**

230/12 V, incl. 36 VA  
40 mm 2,5 mm<sup>2</sup> ⇔ 210 mm 60 mm  
⇔ 10 m  
EAN 4000870 501153  
**501.15 new**

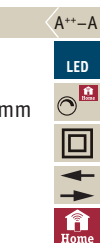

not incl.  
**Remote Control**  
□ = 400  
 **Bluetooth®**

- Chrom matt Metall
- Chrome mat Métal
- Chroom mat Metaal



- ⌘ Weiß/Chrom matt ▣ Kunststoff
- ⌘ Blanc/Chrome mat ▣ Matière plastique
- ⌘ Wit/Chroom mat ▣ Kunststof

230V → Trafo = 12V --- DC



#### TunLED

A++-A

incl. 5×4 W  
5×360 lm, 2.700 K  
230/12V, incl. ⚡ 30 VA  
⌘ 160 mm 1,5 mm<sup>2</sup> ⇔ 10 m  
EAN 4000870 039809

**3980 new**

LED



- ⌘ Weiß/Schwarz/Chrom ▣ Kunststoff
- ⌘ Blanc/Noir/Chrome ▣ Matière plastique
- ⌘ Wit/Zwart/Chroom ▣ Kunststof

230V → Trafo = 12V --- DC



#### TubeLED

A++-A

incl. 5×4 W  
5×360 lm, 2.700 K  
230/12V, incl. ⚡ 30 VA  
⌘ 160 mm 2,5 mm<sup>2</sup> ⇔ 10 m  
EAN 4000870 039816

**3981 new**

LED



- ⌘ Schwarz/Blau/Chrom ▣ Kunststoff
- ⌘ Noir/Bleu/Chrome ▣ Matière plastique
- ⌘ Zwart/Blauw/Chroom ▣ Kunststof

230V → Trafo = 12V --- DC

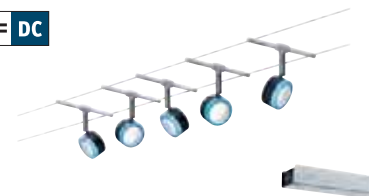

#### BlueLED

A++-A

incl. 5×4 W  
5×360 lm, 2.700 K  
230/12V, incl. ⚡ 30 VA  
⌘ 160 mm 2,5 mm<sup>2</sup> ⇔ 10 m  
EAN 4000870 039823

**3982 new**

LED



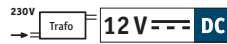

**OrbLED**

A++-A

incl. 5×4 W  
5×360 lm, 2.700 K  
230/12V, incl. ⚡ 30 VA  
⚙️ 160 mm 2,5 mm<sup>2</sup> ⇔ 10 m  
EAN 4000870 039830

**3983 new**



- 🌀 Chrom matt/Chrom 📦 Kunststoff
- 🌀 Chrome mat/Chrome 📦 Matière plastique
- 🌀 Chroom mat/Chroom 📦 Kunststof

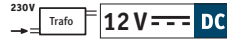

**Set RoundMac**

A++-A

incl. 6×4 W  
6×200 lm, 2.700 K  
230/12V, incl. ⚡ 36 VA  
⚙️ 160 mm 2,5 mm<sup>2</sup> ⇔ 10 m  
EAN 4000870 941065

**941.06**



**Set RoundMac**

A++-A

incl. 4×4 W  
4×200 lm, 2.700 K  
230/12V, incl. ⚡ 36 VA  
⚙️ 160 mm 2,5 mm<sup>2</sup> ⇔ 10 m  
EAN 4000870 941058

**941.05**



- 🌀 Weiß matt 📦 Metall/Kunststoff
- 🌀 Blanc dépoli 📦 Métal/Matière plastique
- 🌀 Wit mat 📦 Metaal/Kunststof

**Spot RoundMac**

A++-A

incl. 1×4 W  
200 lm, 2.700 K  
12V  
⚙️ 160 ⚡ 24 ⌀ 102 mm  
EAN 4000870 940884

**940.88**

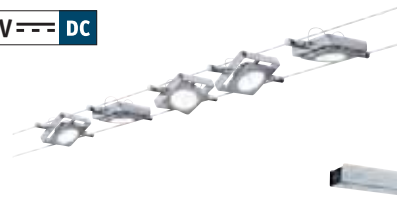
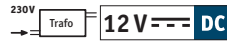

**Set MacLED**

A++-A

incl. 5×4 W  
5×200 lm, 2.700 K  
230/12V, incl. ⚡ 36 VA  
⚙️ 160 mm 2,5 mm<sup>2</sup> ⇔ 10 m  
EAN 4000870 941089

**941.08**



**Set MacLED**

A++-A

incl. 4×4 W  
4×200 lm, 2.700 K  
230/12V, incl. ⚡ 36 VA  
⚙️ 160 mm 2,5 mm<sup>2</sup> ⇔ 10 m  
EAN 4000870 941072

**941.07**



- 🌀 Chrom matt 📦 Metall/Kunststoff
- 🌀 Chrome mat 📦 Métal/Matière plastique
- 🌀 Chroom mat 📦 Metaal/Kunststof

**Spot MacLED**

A++-A

incl. 1×4 W  
200 lm, 2.700 K  
12V  
⚙️ 160 ⚡ 24 ⇔ 92 ⚡ 92 mm  
EAN 4000870 940891

**940.89**



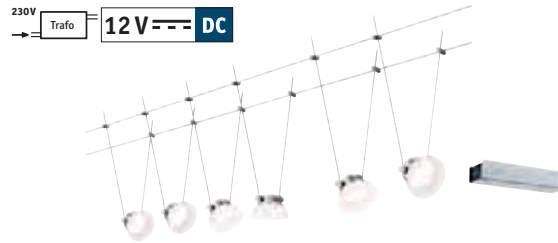

⌘ Chrom matt/Weiß ⌘ Metall/Kunststoff  
 ⌘ Chrome mat/Blanc ⌘ Métal/  
 Matière plastique  
 ⌘ Chroom mat/Wit ⌘ Metaal/Kunststof

**Set IceLED I**

A++-A

incl. 6×4 W  
 6×200 lm, 2.700 K  
 230/12 V, incl. ⚡ 36 VA  
 ⚙ 160 mm 2,5 mm<sup>2</sup> ⇔ 10 m  
 EAN 4000870 941133

**941.13**

LED



⌘ Chrom matt/Weiß ⌘ Metall/Kunststoff  
 ⌘ Chrome mat/Blanc ⌘ Métal/  
 Matière plastique  
 ⌘ Chroom mat/Wit ⌘ Metaal/Kunststof

**Set IceLED II**

A++-A

incl. 6×4 W  
 6×200 lm, 2.700 K  
 230/12 V, incl. ⚡ 30 VA  
 ⚙ 160 mm 2,5 mm<sup>2</sup> ⇔ 10 m  
 EAN 4000870 941157

**941.15**

LED



⌘ Chrom/Satin ⌘ Metall/Kunststoff  
 ⌘ Chrome/Satiné ⌘ Métal/Matière plastique  
 ⌘ Chroom/Satijn ⌘ Metaal/Kunststof

**Set DiscLED I**

A++-A

incl. 5×4 W  
 5×200 lm, 2.700 K  
 230/12 V, incl. ⚡ 36 VA  
 ⚙ 160 mm 2,5 mm<sup>2</sup> ⇔ 10 m  
 EAN 4000870 941096

**941.09**

LED

**Spot DiscLED I**

A++-A

incl. 1×4 W  
 200 lm, 2.700 K  
 12 V  
 ⚙ 160 ⚙ 37 ⚙ 130 mm  
 EAN 4000870 940907

**940.90**

LED



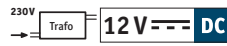

**Set DiscLED II**

A++-A

incl. 5x4 W  
 5x250 lm, 2.700 K  
 230/12V, incl.  $\pm$  30 VA  
 $\pm$  160 mm 2,5 mm<sup>2</sup>  $\leftrightarrow$  10 m  
 EAN 4000870 941102  
**941.10**

LED



- ⌘ Chrom  $\boxtimes$  Metall/Kunststoff
- ⌘ Chrome  $\boxtimes$  Métal/Matière plastique
- ⌘ Chroom  $\boxtimes$  Metaal/Kunststof

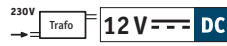

**DC Spot Lense**

A++-A

incl. 1x4,5 W  
 340 lm, 3.000 K  
 $\angle$  25°, 715 cd  
 12V  
 $\pm$  160  $\updownarrow$  165  $\leftrightarrow$  80  $\curvearrowright$  32 mm  
 EAN 4000870 940976  
**940.97**

LED



- ⌘ Chrom/Weiß  $\boxtimes$  Metall/Kunststoff
- ⌘ Chrome/Blanc  $\boxtimes$  Métal/Matière plastique
- ⌘ Chroom/Wit  $\boxtimes$  Metaal/Kunststof

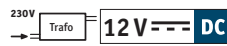
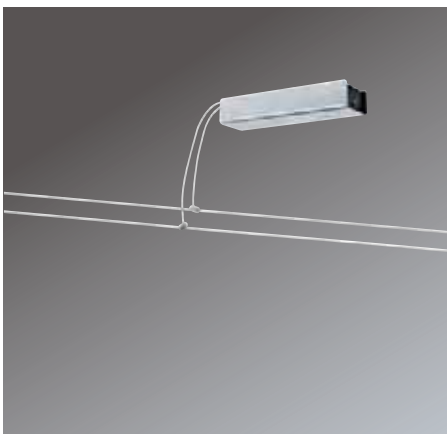

**Set Basic 12V DC**

A++-E

230/12V, incl.  $\pm$  36 VA  
 $\updownarrow$  40 mm 4 mm<sup>2</sup>  $\leftrightarrow$  210 mm  $\curvearrowright$  60 mm  
 $\leftrightarrow$  15 m  
 EAN 4000870 940969  
**940.96**

LED



- ⌘ Chrom matt  $\boxtimes$  Metall
- ⌘ Chrome mat  $\boxtimes$  Métal
- ⌘ Chroom mat  $\boxtimes$  Metaal



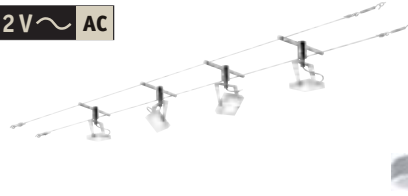

230V **12V** **AC**

**Set Meta**

A++-A

incl. 4×5 W  
4×350 lm, 2.700 K  
230/12 V, incl. 30 VA  
⊕ 160 mm 2,5 mm<sup>2</sup> ⇔ 10 m  
EAN 4000870 940792  
**940.79**

LED



Weiß/Chrom Metall/Glas  
 Blanc/Chrome Métal/Verre  
 Wit/Chroom Metaal/Glas



230V **12V** **AC**

**Set Stage**

A++-A

incl. 4×5 W  
4×300 lm, 2.700 K  
230/12 V, incl. 30 VA  
⊕ 160 mm 2,5 mm<sup>2</sup> ⇔ 10 m  
EAN 4000870 940808  
**940.80**

LED



Weiß/Chrom Metall/Glas  
 Blanc/Chrome Métal/Verre  
 Wit/Chroom Metaal/Glas

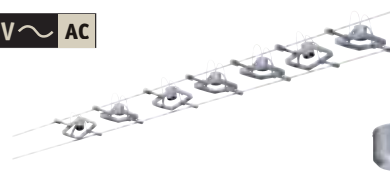

230V **12V** **AC**

**Set Mac II**

A++-E

max. 7×10 W, GU5,3  
230/12 V  
2,5 mm<sup>2</sup> ⇔ 10 m  
EAN 4000870 941522  
**941.52 new**

**Set Mac II**

A++-E

max. 5×10 W, GU5,3  
230/12 V, incl. 60 VA  
⊕ 160 mm 2,5 mm<sup>2</sup> ⇔ 10 m  
EAN 4000870 941331  
**941.33**



Chrom matt Metall/Kunststoff  
 Chrome mat Métal/Matière plastique  
 Chroom mat Metaal/Kunststof

284.66  
283.30  
283.47

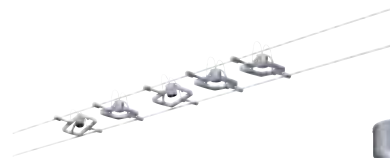
**Spot Mac II**

A++-E

max. 10 W, GU5,3  
12 V  
⊕ 160 ⊕ 55 ⇔ 70 ⊕ 70 mm  
EAN 4000870 941324  
**941.32**





230V **12V** **AC**

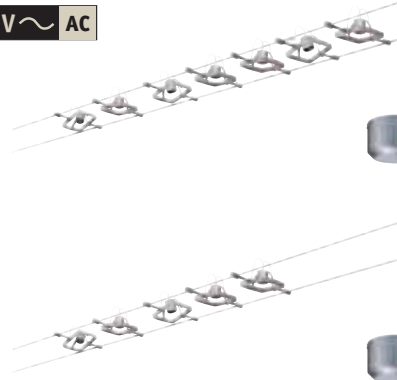

**Set Mac II** A++-E

max. 7×10 W, GU5,3  
230/12V  
2,5 mm<sup>2</sup> ⇔ 10 m  
EAN 4000870 941515  
**941.51 new**

**Set Mac II** A++-E

max. 5×10 W, GU5,3  
230/12V, incl. 60 VA  
 160 mm 2,5 mm<sup>2</sup> ⇔ 10 m  
EAN 4000870 941355  
**941.35**

- Nickel Metall/Kunststoff
- Nickel Métal/Matière plastique
- Nikkel Metaal/Kunststof

284.66  
283.30  
283.47



230V **12V** **AC**

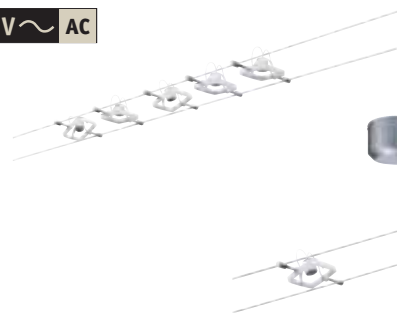

**Set Mac II** A++-E

max. 5×10 W, GU5,3  
230/12V, incl. 60 VA  
 160 mm 2,5 mm<sup>2</sup> ⇔ 10 m  
EAN 4000870 941348  
**941.34**

**Spot Mac II** A++-E

max. 10 W, GU5,3  
12V   
 160 70 mm  
EAN 4000870 941485  
**941.48 new**

- Weiß Metall
- Blanc Métal
- Wit Metaal

284.66  
283.30  
283.47

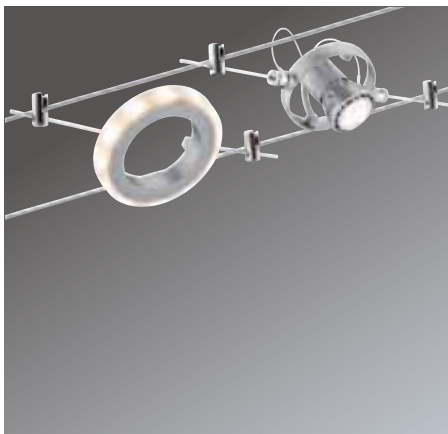

230V **12V** **AC**



**Set HaloLED** A++-E

max. 4×10 W, GU4/  
incl. 3×1,5 W   
230/12V, incl. 80 VA  
 160 mm 2,5 mm<sup>2</sup> ⇔ 12 m  
EAN 4000870 941423  
**941.42**

- Chrom matt Metall
- Chrome mat Métal
- Chroom mat Metaal

282.60





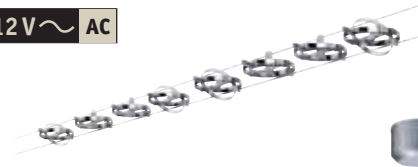



230V  **12V**  AC

**Cardan**

A++-E



max. 8×10 W, GU5,3  
230/12 V  
2,5 mm<sup>2</sup> ⇔ 10 m  
EAN 4000870 941539  
**941.53 new**

 Chrom matt/Chrom  Metall  
 Chrome mat/Chrome  Métal  
 Chroom mat/Chroom  Metaal

 284.66  
283.30  
283.47



**Set Cardan**

A++-E

max. 4×10 W, GU5,3  
230/12 V, incl.  80 VA  
 125 mm 2,5 mm<sup>2</sup> ⇔ 10 m  
EAN 4000870 7  
**941.44**

**Spot Cardan**

A++-E



max. 10 W, GU5,3  
12 V  
 125  100  110 mm  
EAN 4000870 941379  
**941.37**



230V  **12V**  AC





**Set Spice Salt**







A++-E

max. 5×10 W, GU5,3  
230/12 V, incl.  80 VA  
 160 mm 2,5 mm<sup>2</sup> ⇔ 10 m  
EAN 4000870 941454  
**941.45**

**Spot Salt**

A++-E

max. 10 W, GU5,3  
12 V  
 160  30  115  51  
 64 mm  
EAN 4000870 941393  
**941.39**

 Chrom matt  Metall  
 Chrome mat  Métal  
 Chroom mat  Metaal



 284.66  
283.30  
283.47



230V  **12V**  AC





**Set Sheela**

A++-E

max. 5×10 W, GU5,3  
230/12 V, incl.  60 VA  
 160 mm 2,5 mm<sup>2</sup> ⇔ 10 m  
EAN 4000870 941362  
**941.36**

**Spot Sheela**

A++-E

max. 10 W, GU5,3  
12 V  
 160  30  120  65  
 95 mm  
EAN 4000870 941317  
**941.31**

 Chrom matt/Opal  Metall/Glas  
 Chrome mat/Opale  Métal/Verre  
 Chroom mat/Opaal  Metaal/Glas

 283.30



230V **12V ~ AC**



**Set Colmar** A++-E

max. 5×10 W, GU4  
230/12V, incl. 80 VA  
⊕160 mm 2,5 mm<sup>2</sup> ⇔10 m  
EAN 4000870 941430  
**941.43**

**Spot Colmar** A++-E

max. 10 W, GU4  
12 V  
⊕160 ⊕30 ⇕110 ø85  
ø80 mm  
EAN 4000870 941386  
**941.38**

- Chrom/Satin Metall/Glas
- Chrome/Satiné Métal/Verre
- Chroom/Satijn Metaal/Glas

283.29



230V **12V ~ AC**

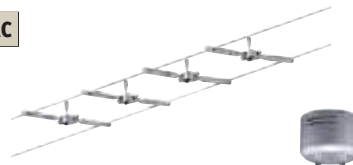

**Set Togo** A++-E

max. 4×10 W, GU5,3  
230/12V, incl. 80 VA  
⊕160 mm 4 mm<sup>2</sup> ⇔10 m  
EAN 4000870 941461  
**941.46**

**Spot Togo** A++-E

max. 10 W, GU5,3  
12 V  
⊕160 ⇕80 ø51 mm  
EAN 4000870 941478  
**941.47**

- Chrom Metall
- Chrome Métal
- Chroom Metaal

283.30



230V **12V ~ AC**

**Spot Comet** A++-E

max. 50 W, GU5,3  
12 V  
⇕300 ⇗300 mm  
EAN 4000870 971130  
**971.1229**

- Chrom Metall
- Chrome Métal
- Chroom Metaal

283.30  
284.66

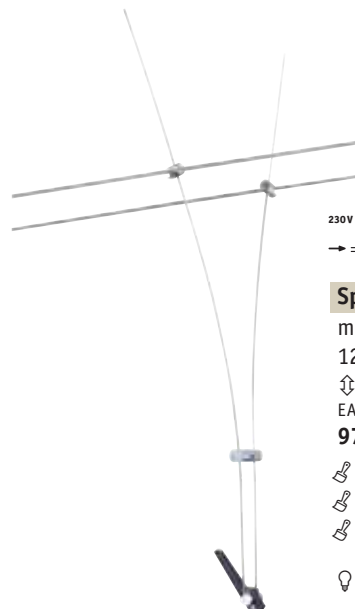

230V **12V ~ AC**

**Spot Light stick** A++-E

max. 50 W, GU5,3  
12 V  
⇕500 ⇗500 mm  
EAN 4000870 971239  
**971.229**

- Chrom Metall
- Chrome Métal
- Chroom Metaal

283.30  
284.66

*Kombinieren Sie selbst Ihr persönliches Lichtsystem*  
*Composez vous-même votre système d'éclairage personnel*  
*Combineer uw persoonlijk lichtstelsel zelf*

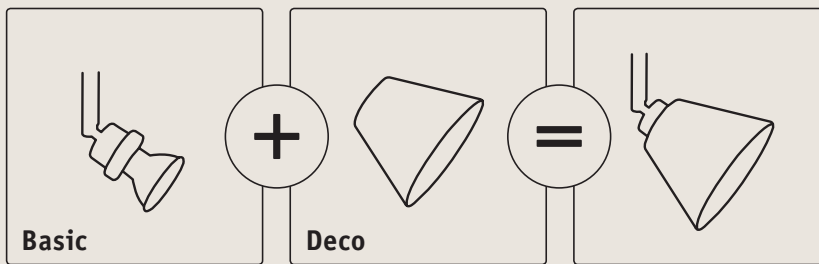

Deco □ = 140-141

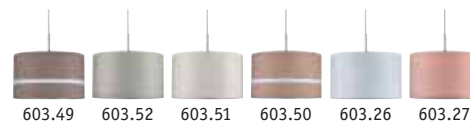

230V 12V ~ AC

### Spot Basic

max. 10 W, GU5,3  
 12 V  
 ⚙️ 160 ⚙️ 130 ⚙️ 130 ⚙️ 95 ⚙️ 75 mm  
 EAN 4000870 941416

**941.41**

🌀 Chrom matt Metall  
 🌀 Chrome mat Métal  
 🌀 Chroom mat Metaal

💡 283.30



230V 12V ~ AC

### 2Easy Basic 12V AC

max. 105 W  
 230/12 V, incl. 105 VA  
 ⚙️ 110 mm ⚙️ 180 mm ⚙️ 2,5 mm<sup>2</sup> ⚙️ 10 m  
 EAN 4000870 940037

**940.03**

🌀 Grau Kunststoff  
 🌀 Gris Matière plastique  
 🌀 Grijs Kunststof

**Wolbi**

max. 50 W  
 ⚡80 ø90 mm  
 EAN 4000870 600115  
**600.11**

- 🌀 Dichroic 🗍 Glas
- 🌀 Dichroïque 🗍 Verre
- 🌀 Dichroisch 🗍 Glas

**Vico**

max. 50 W  
 ⚡95 ø80 mm  
 EAN 4000870 953570  
**953.57**

- 🌀 Klar 🗍 Glas
- 🌀 Clair 🗍 Verre
- 🌀 Helder 🗍 Glas

**Twice**

max. 50 W  
 ⚡70 ø100 mm  
 EAN 4000870 701744  
**701.74**

- 🌀 Klar/Opak 🗍 Glas
- 🌀 Clair/Opaque 🗍 Verre
- 🌀 Helder/Opaak 🗍 Glas

**Vento**

max. 50 W  
 ⚡95 ø80 mm  
 EAN 4000870 953594  
**953.59**

- 🌀 Rauchglas 🗍 Glas
- 🌀 Verre fumé 🗍 Verre
- 🌀 Rookglas 🗍 Glas

**Vento**

max. 50 W  
 ⚡95 ø80 mm  
 EAN 4000870 953587  
**953.58**

- 🌀 Satin 🗍 Glas
- 🌀 Satiné 🗍 Verre
- 🌀 Satijn 🗍 Glas

**Wolbi**

max. 50 W  
 ⚡70 ø90 mm  
 EAN 4000870 600559  
**600.55**

- 🌀 Opal 🗍 Glas
- 🌀 Opale 🗍 Verre
- 🌀 Opaal 🗍 Glas

**Quad**

max. 50 W  
 ⚡80 ø75 mm  
 EAN 4000870 600153  
**600.15**

- 🌀 Weiß 🗍 Glas
- 🌀 Blanc 🗍 Verre
- 🌀 Wit 🗍 Glas

**Kegji**

max. 50 W  
 ⚡80 ø110 mm  
 EAN 4000870 600122  
**600.12**

- 🌀 Weiß 🗍 Glas
- 🌀 Blanc 🗍 Verre
- 🌀 Wit 🗍 Glas

**Wolbi**

max. 50 W  
 ⚡80 ø90 mm  
 EAN 4000870 600078  
**600.07**

- 🌀 Weiß 🗍 Glas
- 🌀 Blanc 🗍 Verre
- 🌀 Wit 🗍 Glas

**Turno**

max. 50 W  
 ⚡90 ø80 mm  
 EAN 4000870 953563  
**953.56**

- 🌀 Satin 🗍 Glas
- 🌀 Satiné 🗍 Verre
- 🌀 Satijn 🗍 Glas

**Zyli**

max. 50 W  
 ⚡80 ø70 mm  
 EAN 4000870 600047  
**600.04**

- 🌀 Weiß 🗍 Glas
- 🌀 Blanc 🗍 Verre
- 🌀 Wit 🗍 Glas

**Rado**

max. 50 W  
 ⚡95 ø70 mm  
 EAN 4000870 953556  
**953.55**

- 🌀 Klar 🗍 Glas
- 🌀 Clair 🗍 Verre
- 🌀 Helder 🗍 Glas

**Wolbi**

max. 50 W  
 ⚡80 ø90 mm  
 EAN 4000870 600092  
**600.09**

- 🌀 Weiß/Alu 🗍 Metall
- 🌀 Blanc/Alu 🗍 Métal
- 🌀 Wit/Alu 🗍 Metaal

**Tessa**

max. 50 W  
 ⌀152 ø255 mm  
 EAN 4000870 603499

**603.49**

- 🌀 Dunkelbraun ☐ Stoff
- 🌀 Marron foncé ☐ Tissus
- 🌀 Donkerbruin ☐ Textiel

**Tessa**

max. 50 W  
 ⌀152 ø255 mm  
 EAN 4000870 603505

**603.50**

- 🌀 Caramel ☐ Stoff
- 🌀 Caramel ☐ Tissus
- 🌀 Caramel ☐ Textiel

**DecoSystems Diffusor**

max. 20 W  
 ⌀1,5 ø255 mm  
 EAN 4000870 954935

**954.93**

- 🌀 Satin ☐ Kunststoff
- 🌀 Satiné ☐ Matière plastique
- 🌀 Satijn ☐ Kunststof

**Tessa**

max. 50 W  
 ⌀152 ø255 mm  
 EAN 4000870 603512

**603.51**

- 🌀 Crème ☐ Stoff
- 🌀 Crème ☐ Tissus
- 🌀 Crème ☐ Textiel

**Tessa**

max. 50 W  
 ⌀152 ø255 mm  
 EAN 4000870 603529

**603.52**

- 🌀 Hellgrau ☐ Stoff
- 🌀 Gris clair ☐ Tissus
- 🌀 Lichtgrijs ☐ Textiel

**Tessa**

max. 50 W  
 ⌀152 ø255 mm  
 EAN 4000870 603260

**603.26**

- 🌀 Weiß ☐ Stoff
- 🌀 Blanc ☐ Tissus
- 🌀 Wit ☐ Textiel

**Tessa**

max. 50 W  
 ⌀152 ø255 mm  
 EAN 4000870 603277

**603.27**

- 🌀 Apricot ☐ Stoff
- 🌀 Abricot ☐ Tissus
- 🌀 Apricot ☐ Textiel

- 🔗 Klar ☐ Kupfer/Kunststoff
- 🔗 Clair ☐ Cuivre/Matière plastique
- 🔗 Helder ☐ Koper/Kunststof



**Sicherheits-Spannseil, isoliert**  
**Câble de tension de sécurité isolé**  
**Veiligheids-spankabel, geïsoleerd**

2,5 mm<sup>2</sup> ⇔ 12 m  
 EAN 4000870 979693  
**979.069** 📦

4 mm<sup>2</sup> ⇔ 12 m  
 EAN 4000870 979556  
**979.055** 📦

6 mm<sup>2</sup> ⇔ 12 m  
 EAN 4000870 979471  
**979.047** 📦

4 mm<sup>2</sup> ⇔ 100 m  
 EAN 4000870 006566  
**979.057**

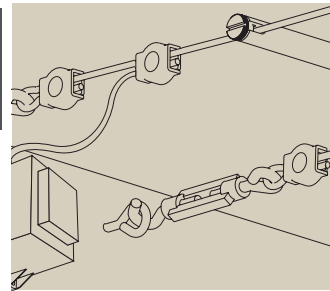

**Sicherheits-Seilklemme, für Stromeinspeisung, 1 Paar**  
**Attache boucle d'alimentation, 1 paire**  
**Veiligheids-kabelklem, voor stroomvoeding, 1 set**

2x



- 🔗 Chrom ☐ Metall
- 🔗 Chrome ☐ Métal
- 🔗 Chroom ☐ Metaal

max. 300 W  
 EAN 4000870 978290  
**978.029** 📦

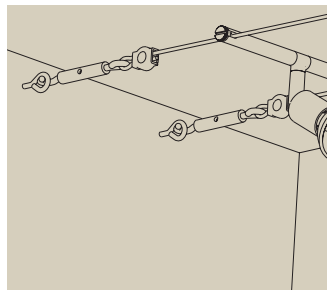

**Spann-Montageset, nicht isoliert**  
**Kit de traction non isolé**  
**Span-montageset, niet geïsoleerd**

2x

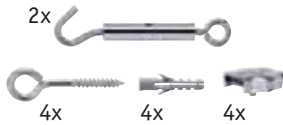

- 🔗 Chrom ☐ Metall
- 🔗 Chrome ☐ Métal
- 🔗 Chroom ☐ Metaal

EAN 4000870 178034  
**178.03** 📦

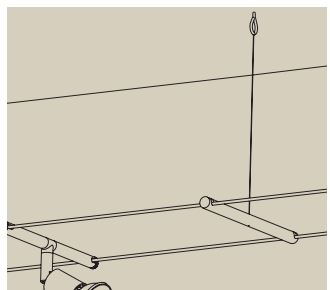

**Zwischenaufhängung**  
**Suspension anti-flèche**  
**Tussenophanging**



- 🔗 Klar ☐ Kunststoff
- 🔗 Clair ☐ Matière plastique
- 🔗 Helder ☐ Kunststof

160 mm ⇔ 100 cm  
 ø12 mm ⇔ 170 mm  
 EAN 4000870 178140  
**178.14** 📦

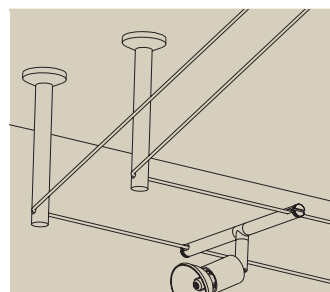

**Umlenker / Abhängung, zum Aufschrauben, 1 Paar**  
**Renvoi d'angle / Support tubes à visser, 1 paire**  
**Ombuiger / Ophanging, opschroefbaar, 1 set**

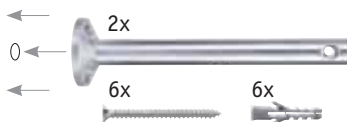

- 🔗 Chrom matt ☐ Metall
- 🔗 Chrome mat ☐ Métal
- 🔗 Chroom mat ☐ Metaal

⇔ 165 ø16 mm  
 EAN 4000870 178065  
**178.06** 📦



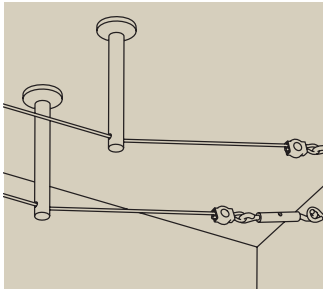

**Umlenker / Abhängung, zum Aufschrauben, 1 Paar**  
**Renvoi d'angle / Support tubes à visser, 1 paire**  
**Ombuiger / Ophanging, opschroefbaar, 1 set**

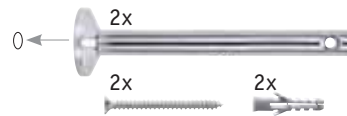

Chrom Metall  
 Chrome Métal  
 Chroom Metaal

165 ø16 mm  
 EAN 4000870 178249  
**178.24**

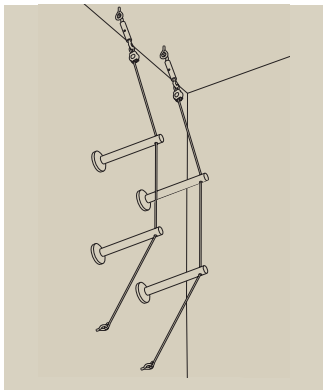

**Spann-Montageset**  
**Kit de traction**  
**Span-montageset**

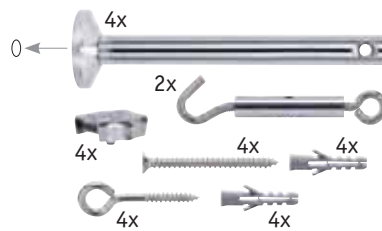

Chrom Metall  
 Chrome Métal  
 Chroom Metaal

165 ø16 mm  
 EAN 4000870 178348  
**178.34**

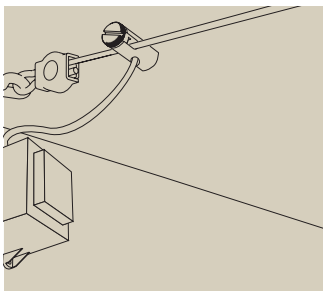

**Stromeinspeisung, 1 Paar**  
**Connecteur d'alimentation, 1 paire**  
**stroomvoeding, 1 set**



Chrom matt Metall  
 Chrome mat Métal  
 Chroom mat Metaal

max. 300 W  
 12 V  
 30 mm ø12 mm 6 mm<sup>2</sup>  
 EAN 4000870 972830  
**972.83**

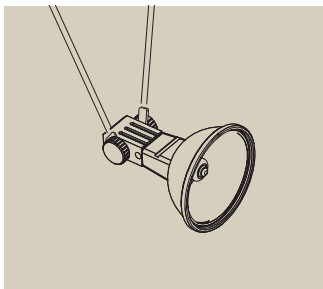

**Socket Lampenhalter, für Seilsysteme**  
**Tête de spot Socket pour câbles**  
**Socket lampenhouder, voor kabelsystemen**



Schwarz Metall  
 Noir Métal  
 Zwart Metaal

max. 35 W, G4  
 12 V  
 EAN 4000870 978412  
**978.41**



Schwarz Metall  
 Noir Métal  
 Zwart Metaal

max. 50 W, GX5,3  
 12 V  
 EAN 4000870 978450  
**978.45**



Weiß Metall  
 Blanc Métal  
 Wit Metaal

max. 50 W, GX5,3  
 12 V  
 EAN 4000870 978443  
**978.44**

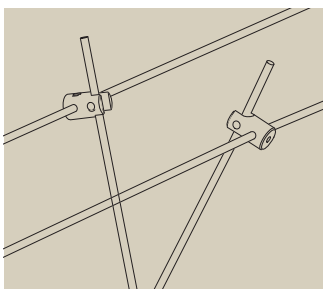

**Seilklotz für Seilsysteme max. 150W / Stangensysteme max. 300W 2er Pack**  
**Sabot contact pour câbles max. 150W / rails max. 300W par 2**  
**Kabelblok voor kabelsystemen max. 150W / stangsystemen max. 300W set van 2 stks**



Chrom Metall  
 Chrome Métal  
 Chroom Metaal

max. 150 W  
 12 V  
 EAN 4000870 978191  
**978.019**

# Rail Systems

- 146 ShiftLED
- 148 URail
- 173 Rail LED/12V



157 Chronos



159 Ceiling Socket



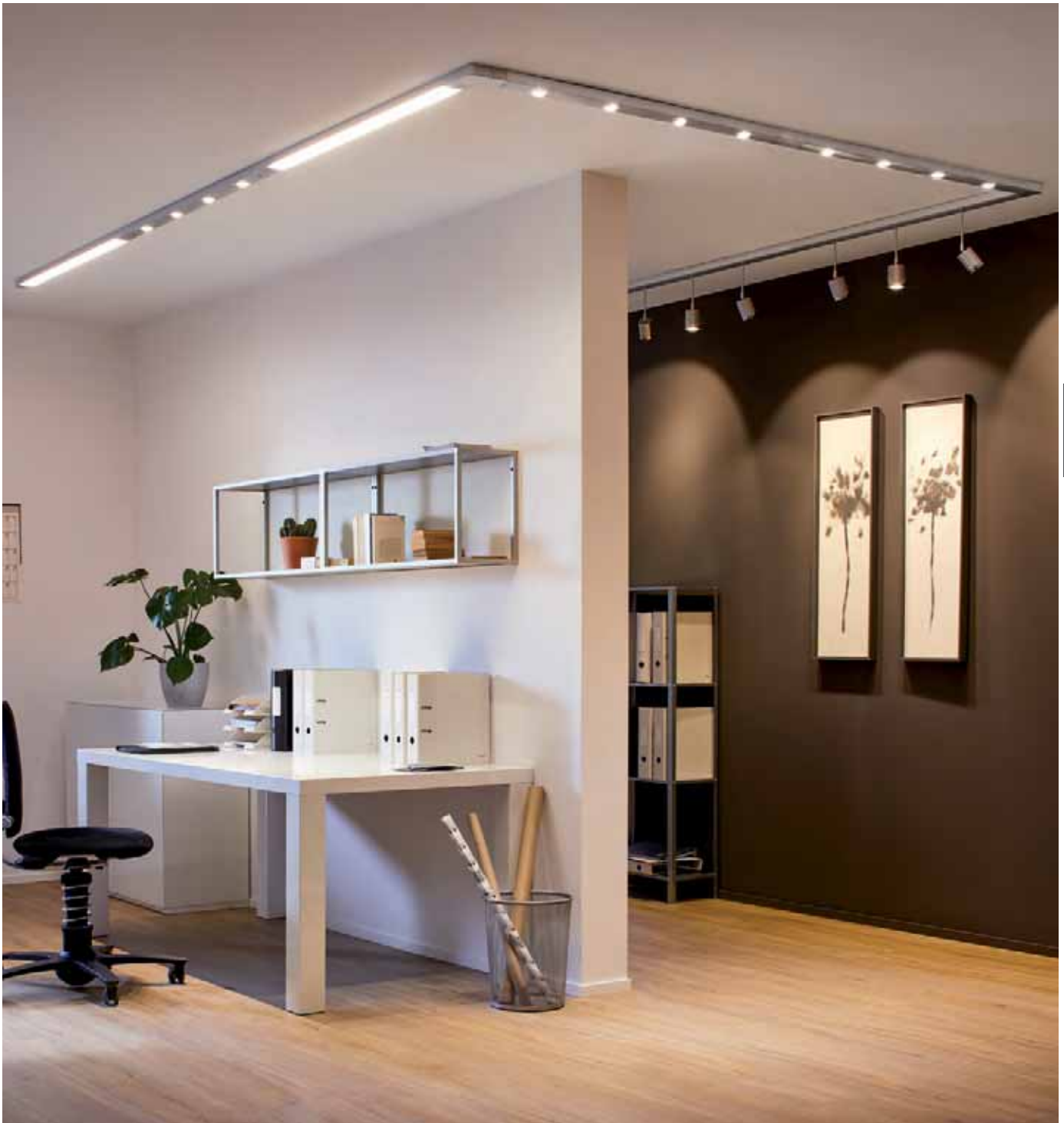

### ShiftLED: Das einfache Schienen-Stecksystem zum Preiseinstieg

Das ShiftLED-Schienensystem ist reduziert auf die wesentlichen Komponenten und bietet so ein faires Einstiegs paket für die Beleuchtung mit einem Schienensystem. Leicht verständlich und auf einen Blick erfassbar lässt sich das System direkt an der Decke montieren. Eine Mittel-/Endeinspeisung ist der Ausgangspunkt, um das Licht mit den jeweils einen Meter langen Leuchtschienen in den Raum zu bringen; mit dem L-Verbinder geht es um die Ecke.

### ShiftLED : Système de connexion simple pour rail en entrée de gamme

Le système rails ShiftLED est réduit aux composants essentiels et offre ainsi un système d'entrée de gamme pour l'éclairage par un système rails. Facilement compréhensible et assimilable au premier coup d'oeil, le système s'installe directement au plafond. Une alimentation à l'extrémité / centrale est le point de départ à l'éclairage d'une pièce avec un rail lumineux d'un mètre de long, le connecteur en L permet de suivre les angles.

### ShiftLED: Het eenvoudige railsteekstelsysteem tegen een instapprijs

Het ShiftLED-railsysteem is beperkt tot de essentiële componenten en biedt zo een fair instappakket voor de verlichting met een railsysteem. Makkelijk te begrijpen en op een blik vatbaar kan het systeem direct aan het plafond worden gemonteerd. Uitgangspunt is een midden-/eindvoeding, om het licht met de telkens één meter lange lichtrail in de ruimte te brengen; met de L-verbinding gaat het om de hoek.



**Glow** A++-A

incl. 1x15 W  
2.000 lm, 3.000 K  
230 V  
⌀32 ⇄1.100 ↗60 mm  
EAN 4000870 902004

**902.00 new**

Alu  Metall/Kunststoff  
Alu  Métal/Matière plastique  
Alu  Metaal/Kunststof



**Downlight** A++-A

incl. 4x5 W  
4x525 lm, 3.000 K  
230 V  
⌀32 ⇄1.100 ↗60 mm  
EAN 4000870 902028

**902.02 new**

Alu  Metall/Kunststoff  
Alu  Métal/Matière plastique  
Alu  Metaal/Kunststof



**Spot** A++-A

incl. 3x7 W  
3x610 lm, 3.000 K  
230 V  
⌀210 ⇄1.100 ↗60 mm  
EAN 4000870 902035

**902.03 new**

Alu  Metall/Kunststoff  
Alu  Métal/Matière plastique  
Alu  Metaal/Kunststof



**Middle-/End-Feed**

230 V  
⌀32 ⇄130 ↗60 mm  
EAN 4000870 902042

**902.04 new**

Alu  Kunststoff  
Alu  Matière plastique  
Alu  Kunststoff



**L-Connector right**

230 V  
⌀32 ⇄100 ↗98 mm  
EAN 4000870 902059

**902.05 new**

Alu  Kunststoff  
Alu  Matière plastique  
Alu  Kunststoff



**L-Connector left**

230 V  
⌀15 ⇄54 ↗25 mm  
EAN 4000870 902066

**902.06 new**

Alu  Kunststoff  
Alu  Matière plastique  
Alu  Kunststoff





### URail – das flexible 230V-Schienensystem von Paulmann

Maximal vielseitig: URail ist das universelle 230 V-Schienensystem zur direkten Deckenmontage oder wahlweise mit Deckenabstand, und das ganz ohne Trafo. Komplettssets, Spots (in 3 Lichttechniken), Pendel und die Schienen gibt es in den Materialfarben Chrom matt oder Weiß.

### URail – le système rail 230V flexible de Paulmann

Aux multiples facettes : URail est le système rail 230 V universel à monter directement et sans transformateur sur plafond ou sur plafond abaissé. Les kits complets, spots (3 technologies combinées), suspensions et rails sont disponibles dans les finitions chrome mat ou blanc.

### URail – het flexibele 230V-railsysteem van Paulmann

Maximaal veelzijdig: URail is het universele 230 V-railsysteem voor directe plafondmontage of naar keuze met plafondafstand, en dat zonder trafo. Complete sets, spots (in 3 lichttechnieken), pendels en rails zijn verkrijgbaar in de materiaalkleuren chroom mat of wit.

*Kombinieren Sie selbst Ihr persönliches Lichtsystem*  
*Composez vous-même votre système d'éclairage personnel*  
*Combineer uw persoonlijk lichtstelsel zelf*

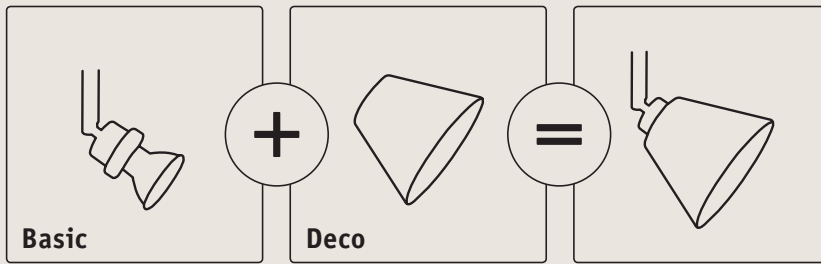

**Basic-Spot**

incl. 1x3,5 W, GZ10,  $\triangle A^+$   
 250 lm, 2.700 K  
 230 V  
 $\updownarrow$ 125  $\varnothing$ 51  $\nearrow$ 50 mm  
 EAN 4000870 951828

**951.82**

- Chrom matt Metall
- Chrome mat Métal
- Chroom mat Metaal

281.87

A++-E

LED

R, C

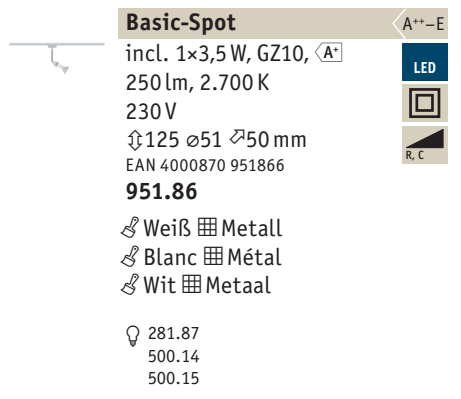

**Basic-Spot**

incl. 1x3,5 W, GZ10,  $\triangle A^+$   
 250 lm, 2.700 K  
 230 V  
 $\updownarrow$ 125  $\varnothing$ 51  $\nearrow$ 50 mm  
 EAN 4000870 951866

**951.86**

- Weiß Metall
- Blanc Métal
- Wit Metaal

281.87  
 500.14  
 500.15

A++-E

LED

R, C



**Basic-Pendulum**

incl. 1x3,5 W, GZ10,  $\triangle A^+$   
 230 V  
 $\updownarrow$ 135 cm  
 EAN 4000870 951835

**951.83**

- Chrom matt Metall
- Chrome mat Métal
- Chroom mat Metaal

285.36

A++-E

LED

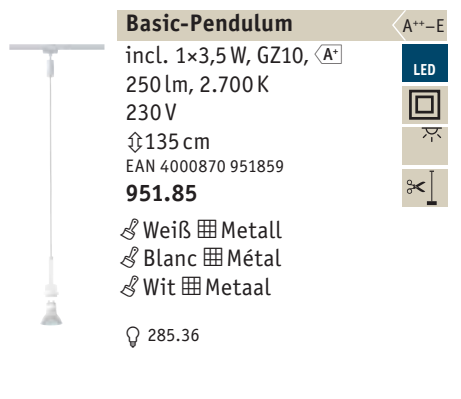

**Basic-Pendulum**

incl. 1x3,5 W, GZ10,  $\triangle A^+$   
 250 lm, 2.700 K  
 230 V  
 $\updownarrow$ 135 cm  
 EAN 4000870 951859

**951.85**

- Weiß Metall
- Blanc Métal
- Wit Metaal

285.36

A++-E

LED

**Wolbi**

max. 50 W  
 ⚡80 ø90 mm  
 EAN 4000870 600115  
**600.11**

- 🌀 Dichroic 📦 Glas
- 🌀 Dichroïque 📦 Verre
- 🌀 Dichroisch 📦 Glas

**Vico**

max. 50 W  
 ⚡95 ø80 mm  
 EAN 4000870 953570  
**953.57**

- 🌀 Klar 📦 Glas
- 🌀 Clair 📦 Verre
- 🌀 Helder 📦 Glas

**Twice**

max. 50 W  
 ⚡70 ø100 mm  
 EAN 4000870 701744  
**701.74**

- 🌀 Klar/Opak 📦 Glas
- 🌀 Clair/Opaque 📦 Verre
- 🌀 Helder/Opaak 📦 Glas

**Vento**

max. 50 W  
 ⚡95 ø80 mm  
 EAN 4000870 953594  
**953.59**

- 🌀 Rauchglas 📦 Glas
- 🌀 Verre fumé 📦 Verre
- 🌀 Rookglas 📦 Glas

**Vento**

max. 50 W  
 ⚡95 ø80 mm  
 EAN 4000870 953587  
**953.58**

- 🌀 Satin 📦 Glas
- 🌀 Satiné 📦 Verre
- 🌀 Satijn 📦 Glas

**Wolbi**

max. 50 W  
 ⚡70 ø90 mm  
 EAN 4000870 600559  
**600.55**

- 🌀 Opal 📦 Glas
- 🌀 Opale 📦 Verre
- 🌀 Opaal 📦 Glas

**Quad**

max. 50 W  
 ⚡80 ø75 mm  
 EAN 4000870 600153  
**600.15**

- 🌀 Weiß 📦 Glas
- 🌀 Blanc 📦 Verre
- 🌀 Wit 📦 Glas

**Kegi**

max. 50 W  
 ⚡80 ø110 mm  
 EAN 4000870 600122  
**600.12**

- 🌀 Weiß 📦 Glas
- 🌀 Blanc 📦 Verre
- 🌀 Wit 📦 Glas

**Wolbi**

max. 50 W  
 ⚡80 ø90 mm  
 EAN 4000870 600078  
**600.07**

- 🌀 Weiß 📦 Glas
- 🌀 Blanc 📦 Verre
- 🌀 Wit 📦 Glas

**Turno**

max. 50 W  
 ⚡90 ø80 mm  
 EAN 4000870 953563  
**953.56**

- 🌀 Satin 📦 Glas
- 🌀 Satiné 📦 Verre
- 🌀 Satijn 📦 Glas

**Zyli**

max. 50 W  
 ⚡80 ø70 mm  
 EAN 4000870 600047  
**600.04**

- 🌀 Weiß 📦 Glas
- 🌀 Blanc 📦 Verre
- 🌀 Wit 📦 Glas

**Rado**

max. 50 W  
 ⚡95 ø70 mm  
 EAN 4000870 953556  
**953.55**

- 🌀 Klar 📦 Glas
- 🌀 Clair 📦 Verre
- 🌀 Helder 📦 Glas

**Wolbi**

max. 50 W  
 ⚡80 ø90 mm  
 EAN 4000870 600092  
**600.09**

- 🌀 Weiß/Alu 📦 Metall
- 🌀 Blanc/Alu 📦 Métal
- 🌀 Wit/Alu 📦 Metaal





**Tessa**

max. 50 W  
 ⚙️ 152 ø255 mm  
 EAN 4000870 603499

**603.49**

- 🔗 Dunkelbraun 📦 Stoff
- 🔗 Marron foncé 📦 Tissus
- 🔗 Donkerbruin 📦 Textiel



**Tessa**

max. 50 W  
 ⚙️ 152 ø255 mm  
 EAN 4000870 603505

**603.50**

- 🔗 Caramel 📦 Stoff
- 🔗 Caramel 📦 Tissus
- 🔗 Caramel 📦 Textiel



**DecoSystems Diffusor**

max. 20 W  
 ⚙️ 1,5 ø255 mm  
 EAN 4000870 954935

**954.93** 📦

- 🔗 Satin 📦 Kunststoff
- 🔗 Satiné 📦 Matière plastique
- 🔗 Satijn 📦 Kunststof



**Tessa**

max. 50 W  
 ⚙️ 152 ø255 mm  
 EAN 4000870 603512

**603.51**

- 🔗 Creme 📦 Stoff
- 🔗 Crème 📦 Tissus
- 🔗 Crème 📦 Textiel



**Tessa**

max. 50 W  
 ⚙️ 152 ø255 mm  
 EAN 4000870 603529

**603.52**

- 🔗 Hellgrau 📦 Stoff
- 🔗 Gris clair 📦 Tissus
- 🔗 Lichtgrijs 📦 Textiel



**Tessa**

max. 50 W  
 ⚙️ 152 ø255 mm  
 EAN 4000870 603260

**603.26**

- 🔗 Weiß 📦 Stoff
- 🔗 Blanc 📦 Tissus
- 🔗 Wit 📦 Textiel



**Tessa**

max. 50 W  
 ⚙️ 152 ø255 mm  
 EAN 4000870 603277

**603.27**

- 🔗 Apricot 📦 Stoff
- 🔗 Abricot 📦 Tissus
- 🔗 Apricot 📦 Textiel





**Spot Dipper** A++-A

incl. 2x8 W  
2x652 lm, 2.700 K  
◄ 83°  
230 V  
⌀170 ⇄375 ↗26 mm  
EAN 4000870 954690

**954.69**

☞ Chrom matt/Weiß ☐ Metall/  
Kunststoff  
☞ Chrome mat/Blanc ☐ Métal/  
Matière plastique  
☞ Chroom mat/Wit ☐ Metaal/  
Kunststof

LED  
☐  
☞  
R, L, C

**Spot Dipper** A++-A

incl. 2x8 W  
2x652 lm, 2.700 K  
◄ 83°  
230 V  
⌀170 ⇄375 ↗26 mm  
EAN 4000870 954706

**954.70**

☞ Weiß/Chrom ☐ Metall/  
Kunststoff  
☞ Blanc/Chrome ☐ Métal/  
Matière plastique  
☞ Wit/Chroom ☐ Metaal/  
Kunststof

LED  
☐  
☞  
R, C



**Spot Double Pellet** A++-A

incl. 2x4 W  
2x294 lm, 2.700 K  
◄ 40°  
230 V  
⌀180 ⇄190 ↗40 mm  
EAN 4000870 954713

**954.71**

☞ Chrom matt/Weiß ☐ Metall/  
Kunststoff  
☞ Chrome mat/Blanc ☐ Métal/  
Matière plastique  
☞ Chroom mat/Wit ☐ Metaal/  
Kunststof

LED  
☐  
☞  
R, L, C

**Spot Double Pellet** A++-A

incl. 2x4 W  
2x294 lm, 2.700 K  
◄ 40°  
230 V  
⌀180 ⇄190 ↗40 mm  
EAN 4000870 954720

**954.72**

☞ Weiß/Chrom matt ☐ Metall/  
Kunststoff  
☞ Blanc/Chrome mat ☐ Métal/  
Matière plastique  
☞ Wit/Chroom mat ☐ Metaal/  
Kunststof

LED  
☐  
☞  
R, L, C



**Spot Pellet** A++-A

incl. 1x4 W  
294 lm, 2.700 K  
◄ 40°  
230 V  
⌀180 ⇄80 ↗40 mm  
EAN 4000870 954737

**954.73**

☞ Chrom matt/Weiß ☐ Metall/  
Kunststoff  
☞ Chrome mat/Blanc ☐ Métal/  
Matière plastique  
☞ Chroom mat/Wit ☐ Metaal/  
Kunststof

LED  
☐  
☞  
R, L, C

**Spot Pellet** A++-A

incl. 1x4 W  
294 lm, 2.700 K  
◄ 40°  
230 V  
⌀180 ⇄80 ↗40 mm  
EAN 4000870 954744

**954.74**

☞ Weiß/Chrom matt ☐ Metall/  
Kunststoff  
☞ Blanc/Chrome mat ☐ Métal/  
Matière plastique  
☞ Wit/Chroom mat ☐ Metaal/  
Kunststof

LED  
☐  
☞  
R, L, C

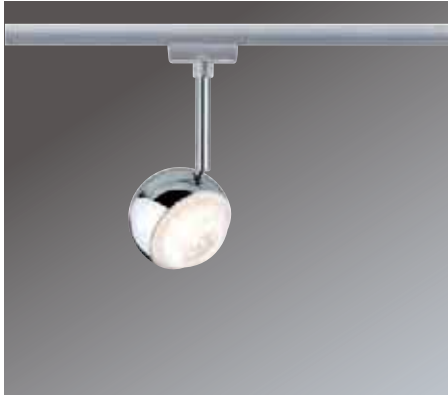

**Spot Capsule II** A++-A

incl. 1×6 W  
420 lm, 2.700 K  
↙ 30°  
230 V  
⌀210 ⇄80 ↗80 mm  
EAN 4000870 954553  
**954.55**

☞ Chrom matt/Chrom ☒ Metall/  
Kunststoff  
☞ Chrome mat/Chrome ☒ Métal/  
Matière plastique  
☞ Chroom mat/Chroom  
☒ Metaal/Kunststof

LED  
☐  
R, L, C

**Spot Capsule II** A++-A

incl. 1×6 W  
420 lm, 2.700 K  
↙ 30°  
230 V  
⌀210 ⇄80 ↗80 mm  
EAN 4000870 954560  
**954.56**

☞ Weiß/Chrom ☒ Metall/  
Kunststoff  
☞ Blanc/Chrome ☒ Métal/  
Matière plastique  
☞ Wit/Chroom ☒ Metaal/  
Kunststof

LED  
☐  
R, L, C



Inline Twenty



Inline Fourty



Inline Twenty



**Spot Inline Twenty** A++-A

incl. 1×2 W  
108 lm, 2.700 K  
230 V  
⌀16 ⇄200 ↗8,5 mm  
EAN 4000870 952917  
**952.91** ☞

☞ Transparent ☒ Kunststoff  
☞ Transparent  
☒ Matière plastique  
☞ Transparant ☒ Kunststof

LED  
☐

**Spot Inline Fourty** A++-A

incl. 1×3,3 W  
222 lm, 2.700 K  
230 V  
⌀16 ⇄400 ↗8,5 mm  
EAN 4000870 952924  
**952.92** ☞

☞ Transparent ☒ Kunststoff  
☞ Transparent  
☒ Matière plastique  
☞ Transparant ☒ Kunststof

LED  
☐

**Spot Inline Ninety** A++-A

incl. 1×5,2 W  
501 lm, 2.700 K  
230 V  
⌀16 ⇄900 ↗8,5 mm  
EAN 4000870 952931  
**952.93** ☞

☞ Transparent ☒ Kunststoff  
☞ Transparent  
☒ Matière plastique  
☞ Transparant ☒ Kunststof

LED  
☐

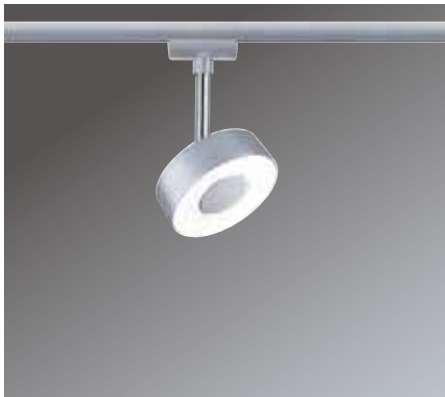
**Spot Circle**

A++-A

incl. 1x5 W  
308 lm, 2.700 K  
∠ 90°  
230 V  
⌀147 ⇄98 ↗50 mm  
EAN 4000870 952719

**952.71**

☞ Chrom matt ☐ Metall/  
Kunststoff  
☞ Chrome mat ☐ Métal/  
Matière plastique  
☞ Chroom mat ☐ Metaal/  
Kunststof

LED

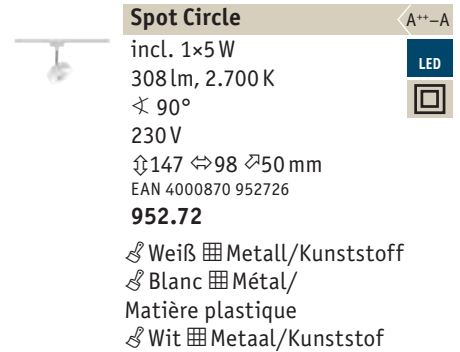
**Spot Circle**

A++-A

incl. 1x5 W  
308 lm, 2.700 K  
∠ 90°  
230 V  
⌀147 ⇄98 ↗50 mm  
EAN 4000870 952726

**952.72**

☞ Weiß ☐ Metall/Kunststoff  
☞ Blanc ☐ Métal/  
Matière plastique  
☞ Wit ☐ Metaal/Kunststof

LED

**Spot Wankel**

A++-A

incl. 1x5,4 W  
450 lm, 2.700 K  
∠ 35°  
230 V  
⌀173 ø55 ↗78 mm  
EAN 4000870 952047

**952.04**

☞ Chrom matt/Chrom ☐ Metall/  
Kunststoff  
☞ Chrome mat/Chrome ☐ Métal/  
Matière plastique  
☞ Chroom mat/Chroom  
☐ Metaal/Kunststof

LED

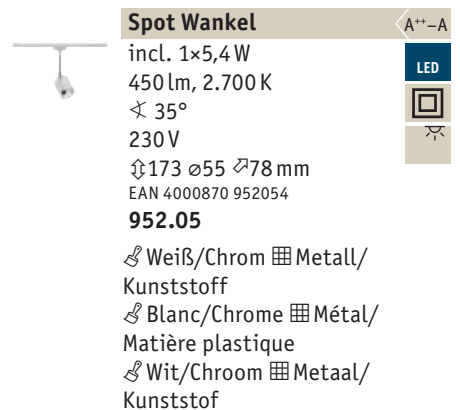
**Spot Wankel**

A++-A

incl. 1x5,4 W  
450 lm, 2.700 K  
∠ 35°  
230 V  
⌀173 ø55 ↗78 mm  
EAN 4000870 952054

**952.05**

☞ Weiß/Chrom ☐ Metall/  
Kunststoff  
☞ Blanc/Chrome ☐ Métal/  
Matière plastique  
☞ Wit/Chroom ☐ Metaal/  
Kunststof

LED

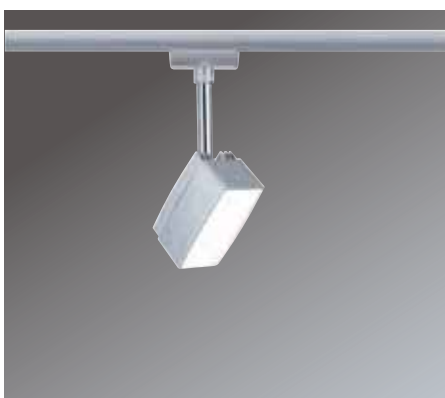
**Spot Pedal**

A++-A

incl. 1x5 W  
395 lm, 2.700 K  
∠ 100°  
230 V  
⌀175 ⇄50 ↗48 mm  
EAN 4000870 952696

**952.69**

☞ Chrom matt ☐ Metall/  
Kunststoff  
☞ Chrome mat ☐ Métal/  
Matière plastique  
☞ Chroom mat ☐ Metaal/  
Kunststof

LED

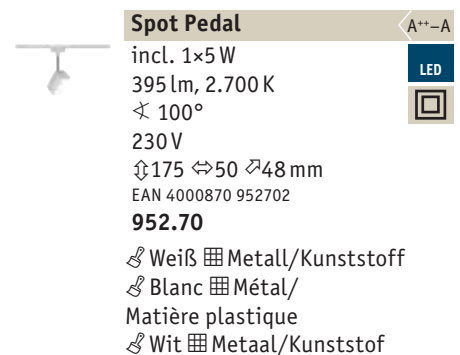
**Spot Pedal**

A++-A

incl. 1x5 W  
395 lm, 2.700 K  
∠ 100°  
230 V  
⌀175 ⇄50 ↗48 mm  
EAN 4000870 952702

**952.70**

☞ Weiß ☐ Metall/Kunststoff  
☞ Blanc ☐ Métal/  
Matière plastique  
☞ Wit ☐ Metaal/Kunststof

LED

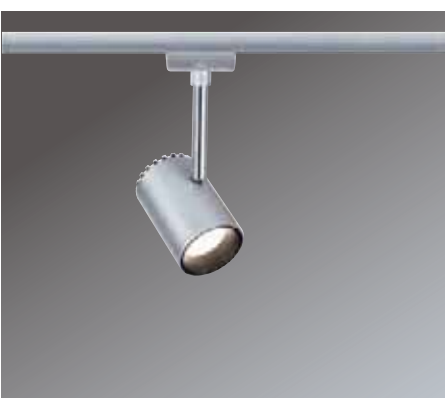
**Spot Shine**

A++-A

incl. 1x5 W  
225 lm, 2.700 K  
∠ 75°  
230 V  
⌀180 ⇄59 ↗90 mm  
EAN 4000870 952733

**952.73**

☞ Chrom matt ☐ Metall/  
Kunststoff  
☞ Chrome mat ☐ Métal/  
Matière plastique  
☞ Chroom mat ☐ Metaal/  
Kunststof

LED

**Spot Shine**

A++-A

incl. 1x5 W  
225 lm, 2.700 K  
∠ 75°  
230 V  
⌀180 ⇄59 ↗90 mm  
EAN 4000870 952832

**952.83**

☞ Weiß ☐ Metall/Kunststoff  
☞ Blanc ☐ Métal/  
Matière plastique  
☞ Wit ☐ Metaal/Kunststof

LED





**Spot Barelli** A++-E

incl. 1x6,5 W, GU10, A+

425 lm, 2.700 K

230 V

⌀165 ø51 ⇄100 ↗51 mm

EAN 4000870 951545

**951.54**

☞ Chrom matt/Chrom M Metall/  
Kunststoff

☞ Chrome mat/Chrome M Métal/  
Matière plastique

☞ Chroom mat/Chroom  
M Metaal/Kunststof

💡 284.64  
283.00

**Spot Barelli** A++-E

incl. 1x6,5 W, GU10, A+

425 lm, 2.700 K

230 V

⌀165 ø51 ⇄100 ↗51 mm

EAN 4000870 951552

**951.55**

☞ Weiß/Chrom M Metall/  
Kunststoff

☞ Blanc/Chrome M Métal/  
Matière plastique

☞ Wit/Chroom M Metaal/  
Kunststof

💡 284.64  
283.00



**Spot Tube** A++-E

incl. 1x6,5 W, GU10, A+

425 lm, 2.700 K

230 V

⌀112 ø65 mm

EAN 4000870 952856

**952.85**

☞ Chrom matt/Chrom M Metall/  
Kunststoff

☞ Chrome mat/Chrome M Métal/  
Matière plastique

☞ Chroom mat/Chroom  
M Metaal/Kunststof

💡 284.64  
283.00

**Spot Tube** A++-E

incl. 1x6,5 W, GU10, A+

425 lm, 2.700 K

230 V

⌀112 ø65 mm

EAN 4000870 952863

**952.86**

☞ Weiß/Chrom M Metall/  
Kunststoff

☞ Blanc/Chrome M Métal/  
Matière plastique

☞ Wit/Chroom M Metaal/  
Kunststof

💡 284.64  
283.00



**Spot Cone** A++-E

max. 10 W, GU10

230 V

⌀180 ø85 ↗90 mm

EAN 4000870 976135

**976.13**

☞ Chrom matt/Chrom M Metall/  
Kunststoff

☞ Chrome mat/Chrome M Métal/  
Matière plastique

☞ Chroom mat/Chroom  
M Metaal/Kunststof

💡 284.64  
500.61  
500.62

**Spot Cone** A++-E

max. 10 W, GU10

230 V

⌀180 ø85 ↗90 mm

EAN 4000870 953624

**953.62**

☞ Weiß/Chrom M Metall/  
Kunststoff

☞ Blanc/Chrome M Métal/  
Matière plastique

☞ Wit/Chroom M Metaal/  
Kunststof

💡 284.64  
500.61  
500.62



**Spot Pipe** A++-E

max. 10 W, GU10

230 V

⌀150 ø65 ↗100 mm

EAN 4000870 976128

**976.12**

☞ Chrom matt/Chrom M Metall/  
Kunststoff

☞ Chrome mat/Chrome M Métal/  
Matière plastique

☞ Chroom mat/Chroom  
M Metaal/Kunststof

💡 284.64  
500.61  
500.62

**Spot Pipe** A++-E

max. 10 W, GU10

230 V

⌀150 ø65 ↗100 mm

EAN 4000870 953631

**953.63**

☞ Weiß/Chrom M Metall/  
Kunststoff

☞ Blanc/Chrome M Métal/  
Matière plastique

☞ Wit/Chroom M Metaal/  
Kunststof

💡 284.64  
500.61  
500.62

**Spot Pure I**

A++-E

max. 10 W, GU10  
230 V  
⌀110 ⇄58 ⌀66 mm  
EAN 4000870 953297

**953.29**

🔗 Chrom matt/Chrom 📦 Metall/  
Kunststoff  
🔗 Chrome mat/Chrome 📦 Métal/  
Matière plastique  
🔗 Chroom mat/Chroom 📦 Metaal/  
Kunststof

💡 284.64  
285.36  
500.61  
500.62

LED

**Spot Pure I**

A++-E

max. 10 W, GU10  
230 V  
⌀110 ⇄58 ⌀66 mm  
EAN 4000870 953303

**953.30**

🔗 Weiß/Chrom 📦 Metall/  
Kunststoff  
🔗 Blanc/Chrome 📦 Métal/  
Matière plastique  
🔗 Wit/Chroom 📦 Metaal/  
Kunststof

💡 284.64  
285.36  
500.61  
500.62

**Spot Pure II**

A++-E

max. 10 W, GU10  
230 V  
⌀110 ⇄58 ⌀66 mm  
EAN 4000870 953310

**953.31**

🔗 Chrom matt/Chrom 📦 Metall/  
Kunststoff  
🔗 Chrome mat/Chrome 📦 Métal/  
Matière plastique  
🔗 Chroom mat/Chroom 📦 Metaal/  
Kunststof

🔗 Chrom matt/Chrom 📦 Metall/  
Kunststoff  
🔗 Chrome mat/Chrome 📦 Métal/  
Matière plastique  
🔗 Chroom mat/Chroom 📦 Metaal/  
Kunststof

💡 284.64  
285.36  
500.61  
500.62

LED

**Spot Pure II**

A++-E

max. 10 W, GU10  
230 V  
⌀110 ⇄58 ⌀66 mm  
EAN 4000870 953334

**953.33**

🔗 Weiß/Chrom 📦 Metall/  
Kunststoff  
🔗 Blanc/Chrome 📦 Métal/  
Matière plastique  
🔗 Wit/Chroom 📦 Metaal/  
Kunststof

**Starter Set Pure II**

A++-E

max. 3×10 W, GU10  
230 V  
⇄1,2 m  
EAN 4000870 954638

**954.63****Spot Barelli**

A++-E

max. 10 W, GU10  
230 V  
⌀138 ⇄68 ⌀35 mm  
EAN 4000870 954614

**954.61**

🔗 Chrom matt/Chrom 📦 Metall/  
Kunststoff  
🔗 Chrome mat/Chrome 📦 Métal/  
Matière plastique  
🔗 Chroom mat/Chroom 📦 Metaal/  
Kunststof

🔗 Chrom matt/Chrom 📦 Metall/  
Kunststoff  
🔗 Chrome mat/Chrome 📦 Métal/  
Matière plastique  
🔗 Chroom mat/Chroom 📦 Metaal/  
Kunststof

💡 284.64  
285.36  
500.61  
500.62

LED

**Starter Set Barelli**

A++-E

max. 3×10 W, GU10  
230 V  
⇄1,2 m  
EAN 4000870 954591

**954.59**



⚙ Chrom matt/Chrom  Metall/Kunststoff  
 ⚙ Chrome mat/Chrome  Métal/  
 Matière plastique  
 ⚙ Chroom mat/Chroom  Metaal/Kunststof

⚡ 284.64  
 ⚡ 500.61  
 ⚡ 500.62



**Spot Cover**

A++-E

max. 10 W, GU10  
 230 V  
 ⚡140 ⇄58 ⚡90 mm  
 EAN 4000870 953358  
**953.35**



**Spot Cover**

A++-E

max. 10 W, GU10  
 230 V  
 ⚡140 ⇄58 ⚡90 mm  
 EAN 4000870 953365  
**953.36**



⚙ Weiß/Chrom  Metall/  
 Kunststoff  
 ⚙ Blanc/Chrome  Métal/  
 Matière plastique  
 ⚙ Wit/Chroom  Metaal/Kunststof



**Starter Set Cover**

A++-E

max. 3×10 W, GU10  
 230 V  
 ⇄1,2 m  
 EAN 4000870 954621  
**954.62**



**Spot Blossom**

A++-E

max. 10 W, G9  
 230 V  
 ⚡128 ⇄74 ⚡115 mm  
 EAN 4000870 953372  
**953.37**



⚙ Chrom matt/Satin  Metall/Glas  
 ⚙ Chrome mat/Satiné  Métal/  
 Verre  
 ⚙ Chroom mat/Satijn  Metaal/Glas

⚡ 285.33  
 ⚡ 284.46



**Spot Blossom**

A++-E

max. 10 W, G9  
 230 V  
 ⚡128 ⇄74 ⚡115 mm  
 EAN 4000870 953426  
**953.42**



⚙ Weiß/Satin  Metall/Glas  
 ⚙ Blanc/Satiné  Métal/  
 Verre  
 ⚙ Wit/Satijn  Metaal/Glas

⚡ 285.33  
 ⚡ 284.46



**Spot Blossom**

A++-E

max. 10 W, G9  
 230 V  
 ⚡128 ⇄74 ⚡115 mm  
 EAN 4000870 953389  
**953.38**



⚙ Chrom matt/Klar/Satin  
 Metall/Glas  
 ⚙ Chrome mat/Clair/Satiné  
 Métal/Verre  
 ⚙ Chroom mat/Helder/Satijn  
 Metaal/Glas

⚡ 285.33  
 ⚡ 284.46



**Spot Blossom**

A++-E

max. 10 W, G9  
 230 V  
 ⚡128 ⇄74 ⚡115 mm  
 EAN 4000870 953433  
**953.43**



⚙ Weiß/Klar/Satin  Metall/Glas  
 ⚙ Blanc/Clair/Satiné  Métal/  
 Verre  
 ⚙ Wit/Helder/Satijn  Metaal/  
 Glas

⚡ 285.33  
 ⚡ 284.46

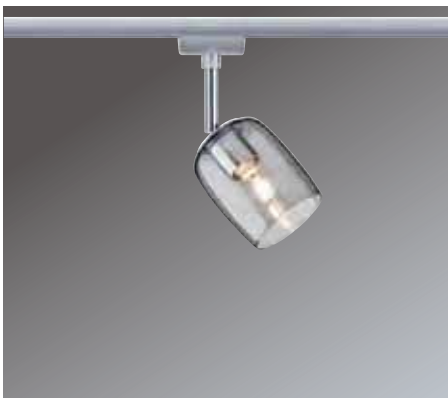

**Spot Blossom**

A++-E

max. 10 W, G9  
 230 V  
 ⚡128 ⇄74 ⚡115 mm  
 EAN 4000870 953396  
**953.39**



⚙ Chrom matt/Rauchglas  
 Metall/Glas  
 ⚙ Chrome mat/Verre fumé  
 Métal/Verre  
 ⚙ Chroom mat/Rookglas  
 Metaal/Glas

⚡ 285.33  
 ⚡ 284.46



**Spot Blossom**

A++-E

max. 10 W, G9  
 230 V  
 ⚡128 ⇄74 ⚡115 mm  
 EAN 4000870 953440  
**953.44**



⚙ Weiß/Grau transparent  
 Metall/Glas  
 ⚙ Blanc/Gris transparent  
 Métal/Verre  
 ⚙ Wit/Grijs transparant  
 Metaal/Glas

⚡ 285.33



not incl.  
Remote Control  
□= 400  
Bluetooth®



#### BLE LED Flutter Chronos

A++-A

incl. 1x12 W  
1.500 lm, 2.700 - 6.500 K  
230 V

⌀122 ⇄266 ↗114 mm  
EAN 4000870 955055

955.05 new

☞ Chrom matt/Weiß  
☞ Metall/Kunststoff  
☞ Chrome mat/Blanc  
☞ Métal/Matière plastique  
☞ Chroom mat/Wit  
☞ Metaal/Kunststof

LED

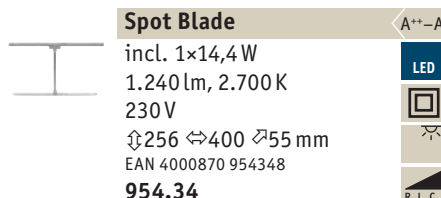

#### Spot Blade

A++-A

incl. 1x14,4 W  
1.240 lm, 2.700 K  
230 V

⌀256 ⇄400 ↗55 mm  
EAN 4000870 954348

954.34

☞ Chrom matt/Chrom ☞ Metall/  
Kunststoff  
☞ Chrome mat/Chrome ☞ Métal/  
Matière plastique  
☞ Chroom mat/Chroom  
☞ Metaal/Kunststof

R, L, C

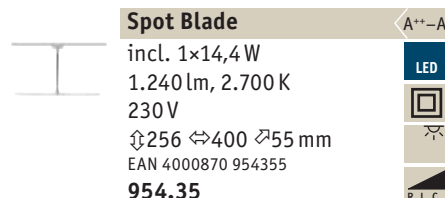

#### Spot Blade

A++-A

incl. 1x14,4 W  
1.240 lm, 2.700 K  
230 V

⌀256 ⇄400 ↗55 mm  
EAN 4000870 954355

954.35

☞ Weiß/Chrom ☞ Metall/  
Kunststoff  
☞ Blanc/Chrome ☞ Métal/  
Matière plastique  
☞ Wit/Chroom ☞ Metaal/  
Kunststof

R, L, C

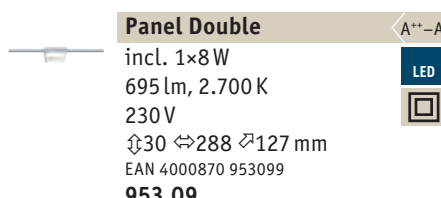

#### Panel Double

A++-A

incl. 1x8 W  
695 lm, 2.700 K  
230 V

⌀30 ⇄288 ↗127 mm  
EAN 4000870 953099

953.09

☞ Chrom matt/Chrom ☞ Kunst-  
stoff  
☞ Chrome mat/Chrome ☞ Mat-  
ière plastique  
☞ Chroom mat/Chroom ☞ Kunst-  
stof

R, L, C

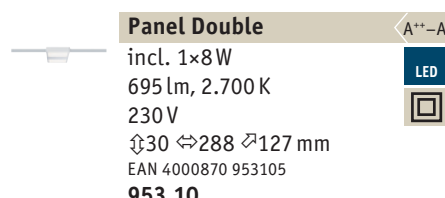

#### Panel Double

A++-A

incl. 1x8 W  
695 lm, 2.700 K  
230 V

⌀30 ⇄288 ↗127 mm  
EAN 4000870 953105

953.10

☞ Weiß/Chrom ☞ Kunststoff  
☞ Blanc/Chrome ☞ Matière plas-  
tique  
☞ Wit/Chroom ☞ Kunststof

R, L, C



**Panel Ring**

A++-A

incl. 1x7 W  
812 lm, 2.700 K  
230 V  
ø220 ↗30 mm  
EAN 4000870 953150  
**953.15**



☞ Chrom matt/Chrom ☒ Kunststoff  
☞ Chrome mat/Chrome ☒ Matière plastique  
☞ Chroom mat/Chroom ☒ Kunststof

**Panel Ring**

A++-A

incl. 1x7 W  
812 lm, 2.700 K  
230 V  
ø220 ↗30 mm  
EAN 4000870 953167  
**953.16**



☞ Weiß/Chrom ☒ Kunststoff  
☞ Blanc/Chrome ☒ Matière plastique  
☞ Wit/Chroom ☒ Kunststof



**Panel Loop**

A++-A

incl. 1x7 W  
812 lm, 2.700 K  
230 V  
↕35 ↔380 ↗110 mm  
EAN 4000870 953198  
**953.19**



☞ Chrom matt/Chrom ☒ Kunststoff  
☞ Chrome mat/Chrome ☒ Matière plastique  
☞ Chroom mat/Chroom ☒ Kunststof

**Panel Loop**

A++-A

incl. 1x7 W  
812 lm, 2.700 K  
230 V  
↕35 ↔380 ↗110 mm  
EAN 4000870 953204  
**953.20**



☞ Weiß/Chrom ☒ Kunststoff  
☞ Blanc/Chrome ☒ Matière plastique  
☞ Wit/Chroom ☒ Kunststof



**Safira**

A++-A

incl. 1x5,2 W  
400 lm, 2.700 K  
230 V  
↕136 ø80 ↔80 mm  
EAN 4000870 955017  
**955.01 new**



☞ Chrom/Klar/Satin ☒ Metall/ Acryl  
☞ Chrome/Clair/Satiné ☒ Métal/ Acryl  
☞ Chroom/Helder/Satijn ☒ Metaal/ Acryl



**Topa**

A++-A

incl. 1x5,2 W  
400 lm, 2.700 K  
230 V  
↕73 ø80 ↔80 mm  
EAN 4000870 955024  
**955.02 new**



☞ Chrom/Klar/Satin ☒ Metall/ Acryl  
☞ Chrome/Clair/Satiné ☒ Métal/ Acryl  
☞ Chroom/Helder/Satijn ☒ Metaal/ Acryl





### Ceiling Socket

A++-E

max. 20 W, E27

230 V

∅96 ∅55 mm

EAN 4000870 952009

**952.00 new**

- Chrom  Metall/Kunststoff

- Chrome  Métal/

- Matière plastique

- Chroom  Metaal/Kunststof

- 283.80

- 283.87

- 283.95

- 284.57

- 284.36



### Ceiling Globe Big

A++-E

max. 20 W, E27

230 V

∅420 ∅300 mm

EAN 4000870 976043

**976.04**

- Chrom matt/Opal  Metall/Glas

- Chrome mat/Opale  Métal/Verre

- Chroom mat/Opaal  Metaal/Glas

- 282.98

- 500.53

- 500.54

- 500.52

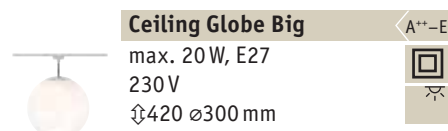

### Ceiling Globe Big

A++-E

max. 20 W, E27

230 V

∅420 ∅300 mm

EAN 4000870 976050

**976.05**

- Weiß/Opal  Metall/Glas

- Blanc/Opale  Métal/Verre

- Wit/Opaal  Metaal/Glas

- 282.98

- 500.53

- 500.54

- 500.52



### Ceiling Globe Small

A++-E

max. 10 W, E14

230 V

∅320 ∅200 mm

EAN 4000870 976029

**976.02**

- Chrom matt/Opal  Metall/Glas

- Chrome mat/Opale  Métal/

- Verre

- Chroom mat/Opaal  Metaal/

- Glas

- 284.67

- 500.55

- 500.56

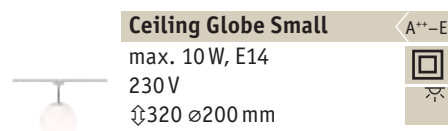

### Ceiling Globe Small

A++-E

max. 10 W, E14

230 V

∅320 ∅200 mm

EAN 4000870 976036

**976.03**

- Weiß/Opal  Metall/Glas

- Blanc/Opale  Métal/Verre

- Wit/Opaal  Metaal/Glas

- 284.67

- 500.55

- 500.56



**Pendulum Capsule II** A++-A

incl. 1x6 W  
420 lm, 2.700 K  
230 V  
⏏ 130 cm ø87 mm  
EAN 4000870 954577  
**954.57**

Chrom matt/Chrom  Metall/  
Kunststoff  
 Chrome mat/Chrome  Métal/  
Matière plastique  
 Chroom mat/Chroom  
 Metaal/Kunststof

**Pendulum Capsule II** A++-A

incl. 1x6 W  
420 lm, 2.700 K  
230 V  
⏏ 130 cm ø87 mm  
EAN 4000870 954584  
**954.58**

Weiß/Chrom  Metall/  
Kunststoff  
 Blanc/Chrome  Métal/  
Matière plastique  
 Wit/Chroom  Metaal/  
Kunststof



**LED Pendulum Barrel** A++-A

incl. 1x6 W  
370 lm, 2.700 K  
∠ 106°, 139 cd  
230 V  
⏏ 135 cm ø85 mm  
EAN 4000870 951774  
**951.77**

Chrom matt/Alu eloxiert  
 Metall/Kunststoff  
 Chrome mat/Alu anodisé  
 Métal/Matière plastique  
 Chroom mat/Alu geëloxeerd  
 Metaal/Kunststof



**Remo II** A++-E

max. 25 W, GU10  
230 V  
⌀200 mm ⌀158 cm ø125 mm  
EAN 4000870 949993  
**949.99 new**

☞ Chrom matt/Satin ☒ Glas/  
Metall  
☞ Chrome mat/Satiné ☒ Verre/  
Métal  
☞ Chroom mat/Satijn ☒ Glas/  
Metaal

💡 284.18



**Arido II** A++-E

incl. 1x5 W, GU10, A+  
490 lm, 2.700 K  
230 V  
⌀200 mm ⌀158 cm ø110 mm  
EAN 4000870 949986  
**949.98 new**

☞ Chrom matt/Klar/Satin  
☒ Glas/Metall  
☞ Chrome mat/Clair/Satiné  
☒ Verre/Métal  
☞ Chroom mat/Helder/Satijn  
☒ Glas/Metaal

💡 284.18



**Pendulum Sarrasani** A++-E

max. 10 W, GU10  
230 V  
⌀135 cm ø140 mm  
EAN 4000870 954515  
**954.51**

☞ Chrom matt/Dichroic  
☒ Metall/Glas  
☞ Chrome mat/Dichroïque  
☒ Métal/Verre  
☞ Chroom mat/Dichroïsch  
☒ Metaal/Glas

💡 283.56



**Pendulum Sarrasani** A++-E

max. 10 W, GU10  
230 V  
⌀135 cm ø140 mm  
EAN 4000870 954508  
**954.50**

☞ Chrom matt/Opal ☒ Metall/  
Glas  
☞ Chrome mat/Opale ☒ Métal/  
Verre  
☞ Chroom mat/Opaal ☒ Metaal/  
Glas

💡 283.56

**Pendulum Sarrasani** A++-E

max. 20 W, GZ10 / GU10  
230 V  
⌀135 cm ø140 mm  
EAN 4000870 954904  
**954.90**

☞ Weiß/Opal ☒ Metall/Glas  
☞ Blanc/Opale ☒ Métal/Verre  
☞ Wit/Opaal ☒ Metaal/Glas

💡 283.56

*Kombinieren Sie selbst Ihr persönliches Lichtsystem*  
*Composez vous-même votre système d'éclairage personnel*  
*Combineer uw persoonlijk lichtstelsel zelf*

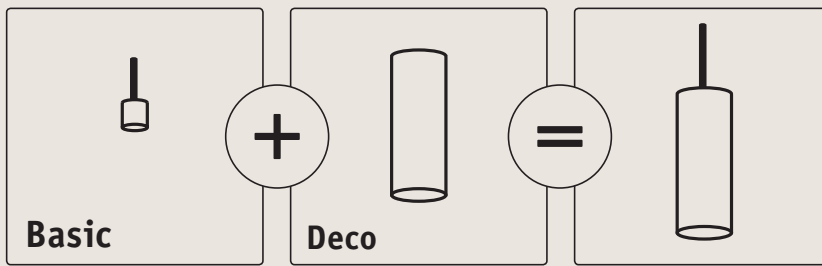

**2Easy Basic Pendulum** A++-E

max. 20 W, E27  
 230 V  
 ⚙️ 150 cm  
 EAN 4000870 954362  
**954.36**

- 🔗 Chrom matt/Chrom   Metall/  
Kunststoff
- 🔗 Chrome mat/Chrome   Métal/  
Matière plastique
- 🔗 Chroom mat/Chroom   Metaal/  
Kunststof

💡 283.49  
 283.98  
 500.52  
 500.53  
 500.54

**2Easy Basic Pendulum** A++-E

max. 20 W, E27  
 230 V  
 ⚙️ 150 cm  
 EAN 4000870 954379  
**954.37**

- 🔗 Weiß/Chrom   Metall/Kunststoff
- 🔗 Blanc/Chrome   Métal/  
Matière plastique
- 🔗 Wit/Chroom   Metaal/Kunststof

💡 283.49  
 283.98  
 500.52  
 500.53  
 500.54



**2Easy Diffusor**

max. 20 W  
 ø454 mm  
 EAN 4000870 954928  
**954.92**

- 🔗 Satin   Kunststoff
- 🔗 Satiné   Matière plastique
- 🔗 Satijn   Kunststof



**Tessa**

max. 50 W  
 ⚙️ 260 ø454 mm  
 EAN 4000870 954652  
**954.65**

- 🔗 Hellgrau   Stoff
- 🔗 Gris clair   Tissus
- 🔗 Lichtgrijs   Textiel



**Tessa**

max. 50 W  
 ⚙️ 260 ø454 mm  
 EAN 4000870 954669  
**954.66**

- 🔗 Crème   Stoff
- 🔗 Crème   Tissus
- 🔗 Crème   Textiel



**Tessa**

max. 50 W  
 ⚙️ 260 ø454 mm  
 EAN 4000870 954676  
**954.67**

- 🔗 Caramel   Stoff
- 🔗 Caramel   Tissus
- 🔗 Caramel   Textiel



**Tessa**

max. 50 W  
 ⚙️ 260 ø454 mm  
 EAN 4000870 954683  
**954.68**

- 🔗 Dunkelbraun   Stoff
- 🔗 Marron foncé   Tissus
- 🔗 Donkerbruin   Textiel



### Livo

↑280 ø75 mm  
EAN 4000870 998427

**998.42**

- ↳ Opal ▣ Glas
- ↳ Opale ▣ Verre
- ↳ Opaal ▣ Glas



### Shade Pien

max. 20 W  
↑230 ø250 mm  
EAN 4000870 954430

**954.43**

- ↳ Rosa matt ▣ Metall
- ↳ Rose dépoli ▣ Métal
- ↳ Rose mat ▣ Metaal



### Shade Pirm

max. 20 W  
↑230 ø280 mm  
EAN 4000870 954409

**954.40**

- ↳ Grau matt ▣ Metall
- ↳ Gris dépoli ▣ Métal
- ↳ Grijs mat ▣ Metaal



### Shade Pien

max. 20 W  
↑230 ø250 mm  
EAN 4000870 954423

**954.42**

- ↳ Beige matt ▣ Metall
- ↳ Beige dépoli ▣ Métal
- ↳ Beige mat ▣ Metaal



### Shade Pom

max. 20 W  
↑240 ø350 mm  
EAN 4000870 954386

**954.38**

- ↳ Weiß matt ▣ Metall
- ↳ Blanc dépoli ▣ Métal
- ↳ Wit mat ▣ Metaal



### Vento

↑280 ø170 mm  
EAN 4000870 953518

**953.51**

- ↳ Klar ▣ Glas
- ↳ Clair ▣ Verre
- ↳ Helder ▣ Glas



### Drio

↑280 ø152 mm  
EAN 4000870 953525

**953.52**

- ↳ Rauchglas ▣ Glas
- ↳ Verre fumé ▣ Verre
- ↳ Rookglas ▣ Glas



### Vico

↑280 ø150 mm  
EAN 4000870 953532

**953.53**

- ↳ Satin ▣ Glas
- ↳ Satiné ▣ Verre
- ↳ Satijn ▣ Glas



### Vento

↑280 ø170 mm  
EAN 4000870 953549

**953.54**

- ↳ Opal ▣ Glas
- ↳ Opale ▣ Verre
- ↳ Opaal ▣ Glas





**Spot Uplight Salto**

A++-A

incl. 1x16 W  
1.316 lm, 2.700 K  
230 V

⌀19 ⇄135 ↗130 mm  
EAN 4000870 953211

**953.21**

- ☞ Chrom matt ☒ Metall/  
Kunststoff
- ☞ Chrome mat ☒ Métal/  
Matière plastique
- ☞ Chroom mat ☒ Metaal/  
Kunststof



**Spot Uplight Salto**

A++-A

incl. 1x16 W, GU10  
1.316 lm, 2.700 K  
230 V

⌀19 ⇄135 ↗130 mm  
EAN 4000870 953228

**953.22**

- ☞ Weiß ☒ Metall/Kunststoff
- ☞ Blanc ☒ Métal/  
Matière plastique
- ☞ Wit ☒ Metaal/Kunststof



**Spot Uplight Case**

A++-A

incl. 1x16 W  
1.408 lm, 2.700 K  
230 V

⌀19 ⇄165 ↗90 mm  
EAN 4000870 953235

**953.23**

- ☞ Chrom matt ☒ Metall/  
Kunststoff
- ☞ Chrome mat ☒ Métal/  
Matière plastique
- ☞ Chroom mat ☒ Metaal/  
Kunststof



**Spot Uplight Case**

A++-A

incl. 1x16 W, GU10  
1.408 lm, 2.700 K  
230 V

⌀19 ⇄165 ↗90 mm  
EAN 4000870 953242

**953.24**

- ☞ Weiß ☒ Metall/Kunststoff
- ☞ Blanc ☒ Métal/  
Matière plastique
- ☞ Wit ☒ Metaal/Kunststof





#### Wall Spot Disc

A++-A

incl. 1x5,5 W  
440 lm, 2.700 K  
∠ 45°  
230 V  
ø95 ⇄410 mm  
EAN 4000870 954546

**954.54**

☞ Chrom matt/Weiß ☒ Metall/  
Kunststoff

☞ Chrome mat/Blanc ☒ Métal/  
Matière plastique

☞ Chroom mat/Wit ☒ Metaal/  
Kunststof



On/Off



#### Wall Spot Torch

A++-A

incl. 1x5,5 W  
440 lm, 2.700 K  
230 V  
⇄35 ⇄43 ⇄486 mm  
EAN 4000870 954522

**954.52**

☞ Chrom matt/Schwarz

☒ Metall/Kunststoff

☞ Chrome mat/Noir ☒ Métal/  
Matière plastique

☞ Chroom mat/Zwart ☒ Metaal/  
Kunststof



On/Off



#### Wall Spot Knob

A++-A

incl. 1x5,5 W  
440 lm, 2.700 K  
∠ 45°  
230 V  
⇄75 ⇄51 ⇄380 mm  
EAN 4000870 954539

**954.53**

☞ Chrom matt/Weiß ☒ Metall/  
Kunststoff

☞ Chrome mat/Blanc ☒ Métal/  
Matière plastique

☞ Chroom mat/Wit ☒ Metaal/  
Kunststof



On/Off



**LED End Cap**

A++-A



incl. 1x5,8 W  
501 lm, 2.700 K  
∠ 80°  
230 V  
∅27 ⇔141 ↗57 mm  
EAN 4000870 954799

LED



R, L, C

**954.79**

☞ Chrom matt ☒ Metall  
☞ Chrome mat ☒ Métal  
☞ Chrom mat ☒ Metaal



**LED End Cap**

A++-A

incl. 1x5,8 W  
501 lm, 2.700 K  
∠ 80°  
230 V  
∅27 ⇔141 ↗57 mm  
EAN 4000870 954805

LED



R, L, C

**954.80**

☞ Weiß ☒ Metall  
☞ Blanc ☒ Métal  
☞ Wit ☒ Metaal



**LED Line Connector**

A++-A



incl. 1x5,8 W  
501 lm, 2.700 K  
∠ 80°  
230 V  
∅27 ⇔225 ↗57 mm  
EAN 4000870 954775

LED



R, L, C

**954.77**

☞ Chrom matt ☒ Metall  
☞ Chrome mat ☒ Métal  
☞ Chrom mat ☒ Metaal



**LED Line Connector**

A++-A

incl. 1x5,8 W  
501 lm, 2.700 K  
∠ 80°  
230 V  
∅27 ⇔225 ↗57 mm  
EAN 4000870 954782

LED



R, L, C

**954.78**

☞ Weiß ☒ Metall  
☞ Blanc ☒ Métal  
☞ Wit ☒ Metaal



**LED L-Connector**

A++-A



incl. 1×5,8W  
501lm, 2.700K  
∠ 80°  
230V  
⇅27 ⇄141 ↗141 mm  
EAN 4000870 954850

**954.85**

- 🔗 Chrom matt  Metall
- 🔗 Chrome mat  Métal
- 🔗 Chroom mat  Metaal

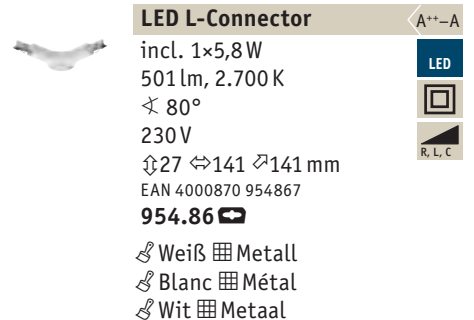
**LED L-Connector**

A++-A



incl. 1×5,8W  
501lm, 2.700K  
∠ 80°  
230V  
⇅27 ⇄141 ↗141 mm  
EAN 4000870 954867

**954.86**

- 🔗 Weiß  Metall
- 🔗 Blanc  Métal
- 🔗 Wit  Metaal

**LED T-Connector**

A++-A



incl. 1×5,8W  
501lm, 2.700K  
∠ 80°  
230V  
⇅27 ⇄224 ↗141 mm  
EAN 4000870 954836

**954.83**

- 🔗 Chrom matt  Metall
- 🔗 Chrome mat  Métal
- 🔗 Chroom mat  Metaal

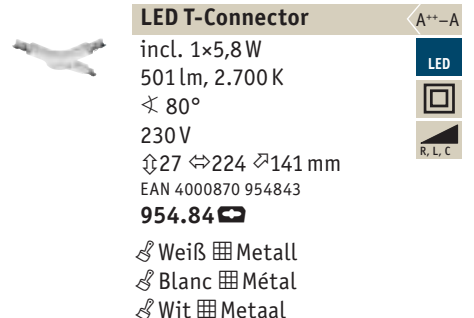
**LED T-Connector**

A++-A



incl. 1×5,8W  
501lm, 2.700K  
∠ 80°  
230V  
⇅27 ⇄224 ↗141 mm  
EAN 4000870 954843

**954.84**

- 🔗 Weiß  Metall
- 🔗 Blanc  Métal
- 🔗 Wit  Metaal

**LED Y-Connector**

A++-A



incl. 1×5,8W  
501lm, 2.700K  
∠ 80°  
230V  
⇅27 ⇄223 ↗195 mm  
EAN 4000870 954812

**954.81**

- 🔗 Chrom matt  Metall
- 🔗 Chrome mat  Métal
- 🔗 Chroom mat  Metaal

**LED Y-Connector**

A++-A



incl. 1×5,8W  
501lm, 2.700K  
∠ 80°  
230V  
⇅27 ⇄223 ↗195 mm  
EAN 4000870 954829

**954.82**

- 🔗 Weiß  Metall
- 🔗 Blanc  Métal
- 🔗 Wit  Metaal



Decke  
Plafond  
Ceiling

Schiene nicht kürzbar  
Rail taille fixe  
Stang kan niet versteld worden

Wand  
Mur  
Wall

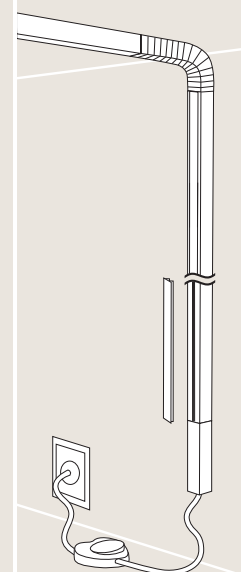
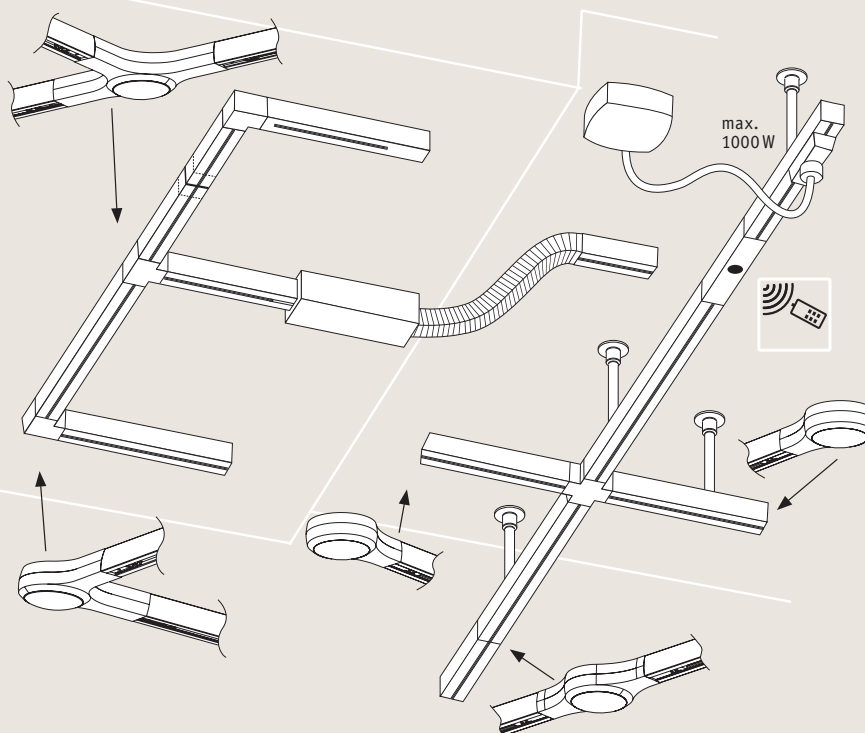



**CM**

- ↳ Chrom matt
- ↳ Chrome mate
- ↳ Chroom mat



**W**

- ↳ Weiß
- ↳ Blanc
- ↳ Wit

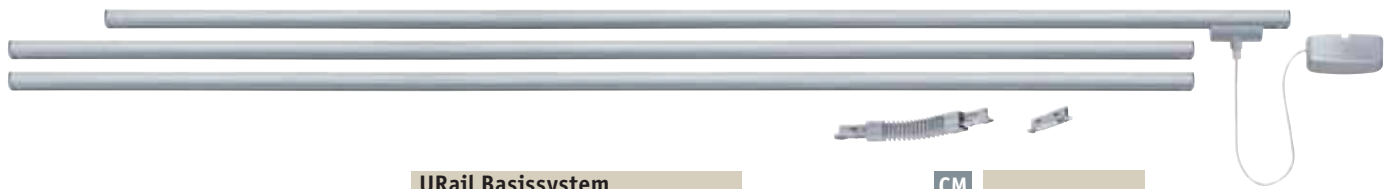

**URail Basissystem**  
**Système de base URail**  
**URail Basissysteem**  
 max. 1.000 W  
 ⇔3,1 m

**CM**  
 EAN 4000870 950166  
**950.16**



**Schiene**  
**Rail**  
**Rail**  
 max. 1.000 W  
 ⚡18 mm ⚡18 mm ⇔0,1 m



**CM** ⇔0,1 m  
 EAN 4000870 950869  
**950.86**

**W** ⇔0,1 m  
 EAN 4000870 954980  
**954.98**



**CM** ⇔0,5 m  
 EAN 4000870 968543  
**968.54**

**W** ⇔0,5 m  
 EAN 4000870 976821  
**976.82**



**CM** ⇔1 m  
 EAN 4000870 968338  
**968.33**

**W** ⇔1 m  
 EAN 4000870 976838  
**976.83**



**CM** ⇔2 m  
 EAN 4000870 968345  
**968.34**

**W** ⇔2 m  
 EAN 4000870 976845  
**976.84**



**Safety Cover strip**

⚡10 mm ⇔0,7 m

EAN 4000870 951262  
**951.26**



**Abhängung**  
**Support tubes**  
**Ophanging**

⚡105 ø23 mm

**CM**  
 EAN 4000870 975992  
**975.99**

**W**  
 EAN 4000870 976883  
**976.88**



**Universal Endcap 2-Pack**

⚡18 ⇔13 ⚡21 mm

**CM**  
 EAN 4000870 954966  
**954.96**

**W**  
 EAN 4000870 954973  
**954.97**



**Linien Verbinder**  
**Connecteur en ligne**  
**Lijnverbinding**

EAN 4000870 951361  
**951.36**

max. 1.000 W  
⌀15 ⇄70 ⌀11 mm



29 mm

**L-Verbinder**  
**L-Connecteur**  
**L-Verbinding**

**CM**   
EAN 4000870 976487  
**976.48**

**W**   
EAN 4000870 976494  
**976.49**

max. 1.000 W  
⌀18 ⇄62 ⌀62 mm



36 mm

**T-Verbinder**  
**T-Conecteur**  
**T-Verbinding**

**CM**   
EAN 4000870 976562  
**976.56**

**W**   
EAN 4000870 976869  
**976.86**

max. 1.000 W  
⌀18 ⇄104 ⌀62 mm



36 mm

**X-Verbinder**  
**X-Conecteur**  
**X-Verbinding**

**CM**   
EAN 4000870 976579  
**976.57**

**W**   
EAN 4000870 976876  
**976.87**

max. 1.000 W  
⌀18 ⇄104 ⌀104 mm

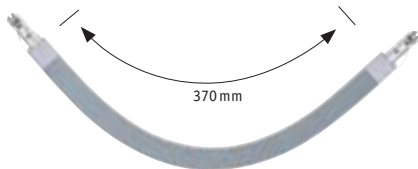

370 mm

**Verbinder Maxiflex**  
**Connecteur Maxiflex**  
**Verbinding Maxiflex**

**CM**   
EAN 4000870 953273  
**953.27**

**W**   
EAN 4000870 953280  
**953.28**

max. 1.000 W  
⌀18 ⇄440 ⌀18 mm

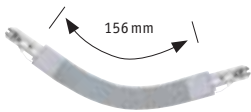

156 mm

**Flex Verbinder II**  
**Connecteur flexible II**  
**Verbinding flexibel II**

**CM**   
EAN 4000870 953259  
**953.25**

**W**   
EAN 4000870 953266  
**953.26**

max. 1.000 W  
⌀18 ⇄227 ⌀18 mm



230V → || ← 230V

**Stromtrenner**  
**Séparateur de circuit**  
**Stroomonderbreker**

EAN 4000870 951408  
**951.40**

⌀18 ⇄70 ⌀18 mm



**Endeinspeisung**  
**Alimentation de fin de ligne**  
**Eindvoeding**

**CM**   
EAN 4000870 976555  
**976.55**

**W**   
EAN 4000870 976852  
**976.85**

max. 1.000 W  
⌀18 ⇄161 ⌀18 mm

not incl.  
Line Connector



**Mittel- / Endeinspeisung**  
**Alimentation en milieu / fin de circuit**  
**Midden- / eindvoeding**

**CM**   
EAN 4000870 968857  
**968.85**

**W**   
EAN 4000870 968864  
**968.86**

max. 1.000 W  
⌀27 ⇄205 ⌀45 mm

not incl.  
Line Connector



**Mittel- / Endeinspeisung**  
**Alimentation en milieu / fin de circuit**  
**Midden- / eindvoeding**

**CM**   
EAN 4000870 968314  
**968.31**

**W**   
EAN 4000870 976791  
**976.79**

max. 1.000 W  
⌀30 mm ⌀75 mm ⇄165 mm  
⇄0,5 m

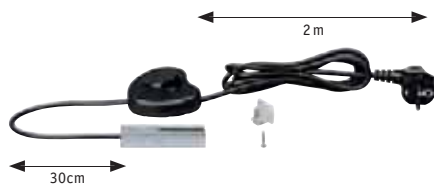

**Endeinspeisung**  
**Alimentation de fin de ligne**  
**Eindvoeding**

max. 1.000 W  
 ⌀18 mm ⇄18 mm ⇄2,4 m

**CM**  
 EAN 4000870 951255  
**951.25**



- ▶ Der Schienenschalter bietet die Möglichkeit nachfolgende Wandabschnitte direkt zu- oder abzuschalten
- ▶ Einfache Steck-Montage

- ▶ Le commutateur rail permet d'activer ou de désactiver directement les sections murales
- ▶ Montage à emboîtement simple

- ▶ De railschakelaar biedt de mogelijkheid de volgende wandgedeelten direct in- of uit te schakelen
- ▶ Eenvoudige steekmontage



**Rail Switch**  
 max. 500 W  
 ⌀18 ⇄135 ⇄18 mm

**CM**  
 EAN 4000870 952825  
**952.82**

**W**  
 EAN 4000870 953112  
**953.11**

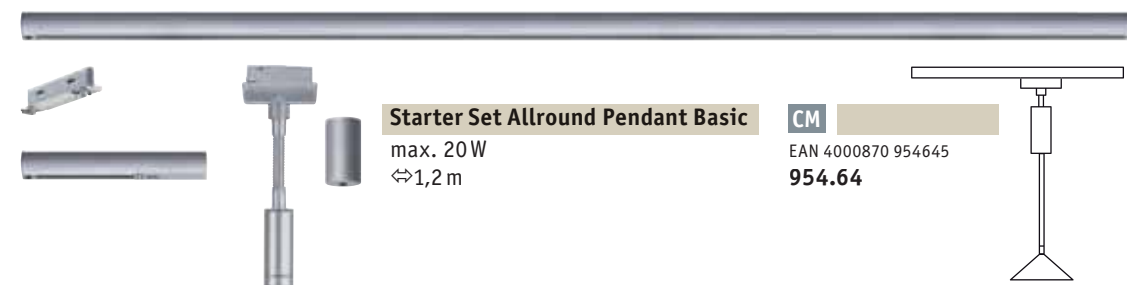

**Starter Set Allround Pendant Basic**  
 max. 20 W  
 ⇄1,2 m

**CM**  
 EAN 4000870 954645  
**954.64**

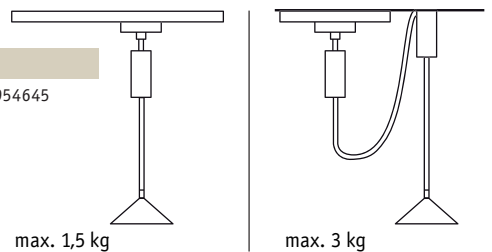

**Universal Pendant Adapter**  
 ⌀106 ⌀62 mm

**CM**  
 EAN 4000870 954942  
**954.94**

**W**  
 EAN 4000870 954959  
**954.95**

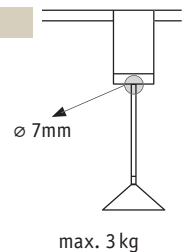

**Adapter für Pendel, kürzbar**  
**Adaptateur pour suspension, réglable**  
**Adapter voor pendel, kan verkort worden**

⇄135 ⌀26 mm

**CM**  
 EAN 4000870 974742  
**974.74**

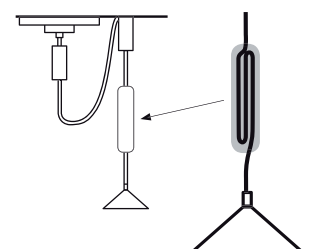

- ▶ Einschaltdauer von 1-30 min. einstellbar
- ▶ Dämmerungssensor ist stufenlos einstellbar
- ▶ Erfasst auch kleine Bewegungen und lässt das Licht so dauerhaft eingeschaltet
- ▶ Einspeisung für URail Schiene zur Montage auf dem Decken- oder Wandauslass
- ▶ Durée d'activation réglable de 1 à 30 minutes
- ▶ Le détecteur crépusculaire est réglable en continu
- ▶ Détecte même les petits mouvements et maintient donc durablement la lumière allumée
- ▶ Alimentation électrique du rail URail pour pose sur prise murale ou au plafond
- ▶ Inschakelduur van 1-30 min instelbaar
- ▶ Schemersensor is traploos instelbaar
- ▶ Registreert ook kleine bewegingen en laat het licht zo duurzaam ingeschakeld
- ▶ Voeding voor URail-railsysteem voor montage aan plafond- of wanduitgang



**Motion Sensor**

max. 500 W  
 ⚡34 ↔235 ↗56 mm

**CM**  
 EAN 4000870 953174  
**953.17** ↔

**W**  
 EAN 4000870 953181  
**953.18** ↔

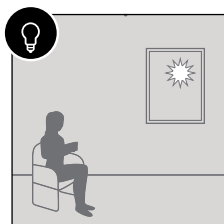

Dämmerungssensor – das Licht wird erst eingeschaltet, wenn es draußen dunkel wird

Détecteur crépusculaire - la lumière ne s'allume qu'à l'obscurité dehors

Schemersensor – het licht wordt pas ingeschakeld, wanneer het buiten donker wordt

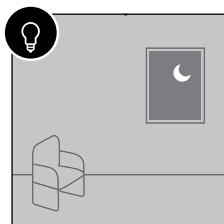

Energiesparend – befindet sich niemand im Raum, bleibt das Licht aus

Économe en énergie - reste éteint si personne n'est présent dans la pièce

Energiebesparend – wanneer zich niemand in de ruimte bevindt, blijft het licht uit

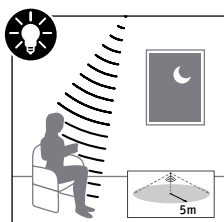

Selbst bei geringer Bewegung bleibt das Licht eingeschaltet

La lumière reste allumée même avec de petits mouvements

Zelfs bij de kleinste beweging blijft het licht ingeschakeld



**Bluetooth Dimm/Switch**

max. 250 W  
 Ω max. 250 W, C max. 100 W, I max. 100 W  
 ⚡35 ↔220 ↗56 mm

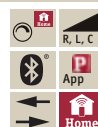

**CM**  
 EAN 4000870 501160  
**501.16** ↔ **new**

**W**  
 EAN 4000870 501177  
**501.17** ↔ **new**

not. incl. **Bluetooth®**  
**Remote Control**  
 ☐= 400



**URail Dimm/Switch Adapter**

max. 400 W  
 Ω max. 400 W, C max. 150 W,  
 ⚡35 ↔155 ↗56 mm

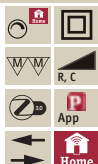

**W**  
 EAN 4000870 500514  
**500.51** **new**

**CM**  
 EAN 4000870 500507  
**500.50** **new**

not. incl. **ZigBee®**  
**Remote Control**  
 ☐= 402



**IR Rail-Switch Fernbedienung**  
**Télécommande commutateur Rail IR**  
**IR rail-schakelaar afstandsbediening**

**CM**  
 EAN 4000870 950739  
**950.73**

⇅7 ⇄40 ↗85 mm

- ▶ Fernbedienung zum komfortablen Schalten oder Dimmen von URail Systemen.
- ▶ Der in einem Verbindungsstück integrierte Empfänger steuert alle nachfolgenden Systemabschnitte.
- ▶ Über die vier Funktionstasten der Fernbedienung können 2 getrennte Schaltungen oder 2 Dimmvorgänge gesteuert werden.

- ▶ Télécommande permettant d'éteindre ou de varier confortablement l'intensité des systèmes de rail en U.
- ▶ Le récepteur intégré dans un connecteur commande la totalité des sections suivantes du système.
- ▶ Les quatre touches de fonctions de la télécommande peuvent commander deux circuits séparés ou deux processus de variation.

- ▶ Afstandsbediening voor comfortabel schakelen of dimmen van URail-systemen.
- ▶ De in een verbindingsstuk geïntegreerde ontvanger stuurt alle volgende systeemdelen.
- ▶ Met de vier functietoetsen kunnen 2 gescheiden schakelingen of 2 dimvoorgangen worden gestuurd.



**IR Rail-Switch**  
**Commutateur Rail IR**  
**IR rail-schakelaar**

**CM**  
 EAN 4000870 976531  
**976.53**

**W**  
 EAN 4000870 976548  
**976.54**

max. 500 W  
 ⇅18 ⇄240 ↗18 mm

- ▶ Mindestlast 3W - für LED geeignet
- ▶ Einfache Steck-Montage
- ▶ Schaltet und dimmt nachfolgende Abschnitte

- ▶ Charge minimale 3 W, adapté aux LED
- ▶ Montage à emboîtement simple
- ▶ Commute et atténue les sections suivantes

- ▶ Minimumbelasting 3 W geschikt voor LED
- ▶ Eenvoudige steekmontage
- ▶ Schakelt en dimt de volgende delen



**Wireless Adapter**

max. 50 W  
 ⇅50 ⇄166 ↗20 mm

**CM**  
 EAN 4000870 952948  
**952.94**

**W**  
 EAN 4000870 952955  
**952.95**

- ▶ Ermöglicht die Steuerung von Einzelköpfen und Gruppenschaltungen, sodass verschiedene Lichtszenarien geschaltet werden können (wie bei einem 2 Phasen-Schienensystem)
- ▶ Alle Gruppen per Fernbedienung schaltbar
- ▶ Filigranes Gehäuse für die Funk-Elektronik
- ▶ Max. 50 W pro Adapter, auch für Halogenleuchten geeignet

- ▶ Permet de contrôler des têtes séparées et des commandes groupées, de sorte les divers scénarios d'éclairage puissent être commutés (comme pour un système sur rail biphasé)
- ▶ Tous les groupes sont commutables par télécommande
- ▶ Boîtier de radiocommunication très mince
- ▶ 50 W maximum par adaptateur, convient également aux lampes halogènes

- ▶ Maakt de besturing van afzonderlijke elementen en groepsschakelingen mogelijk, zodat verschillende lichtscenario's kunnen worden geschakeld (zoals bij een 2-fasenrailsysteem)
- ▶ Alle groepen per afstandsbediening schakelbaar
- ▶ Filigraan behuizing voor de radio-elektronica
- ▶ Max. 50 W per adapter, ook geschikt voor halogeenlampen



**Remote for Wireless Adapter**

**CM**  
 EAN 4000870 952962  
**952.96**



**BLE Adapter**

max. 50 W  
 ⇅50 ⇄166 ↗20 mm

**CM**  
 EAN 4000870 954751  
**954.75** **new**

**W**  
 EAN 4000870 954768  
**954.76** **new**

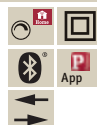

not. incl. **Bluetooth®**  
**Remote Control**  
 □□= 400



- 🌀 Chrom matt   Metall
- 🌀 Chrome mat   Métal
- 🌀 Chroom mat   Metaal

**QuadLED**

incl. 4x4 W  
 4x200 lm, 2.700 K  
 230/12 V, incl.  $\text{⊖}$  30 VA  
 $\text{⊕}$  30 mm  $\leftrightarrow$  1,6 m  
 EAN 4000870 951927  
**951.92**

A++-A

LED

**QuadLED**

incl. 6x4 W  
 6x200 lm, 2.700 K  
 230/12 V, incl.  $\text{⊖}$  30 VA  
 $\text{⊕}$  30 mm  $\leftrightarrow$  2,9 m  
 EAN 4000870 951934  
**951.93**

A++-A

LED





- 🔗 Chrom matt 📦 Metall
- 🔗 Chrome mat 📦 Métal
- 🔗 Chroom mat 📦 Metaal

**IceLED I**

A++-A

incl. 4×4 W  
 4×200 lm, 2.700 K  
 230/12 V, incl. ⚡ 30 VA  
 ⚙️ 30 mm ↔ 1,6 m  
 EAN 4000870 951941  
**951.94**

LED

**IceLED I**

A++-A

incl. 6×4 W  
 6×200 lm, 2.700 K  
 230/12 V, incl. ⚡ 30 VA  
 ⚙️ 30 mm ↔ 3 m  
 EAN 4000870 951958  
**951.95**

LED



- 🔗 Chrom matt 📦 Metall
- 🔗 Chrome mat 📦 Métal
- 🔗 Chroom mat 📦 Metaal

**IceLED II**

A++-A

incl. 4×4 W  
 4×200 lm, 2.700 K  
 230/12 V, incl. ⚡ 30 VA  
 ⚙️ 30 mm ↔ 1,6 m  
 EAN 4000870 951965  
**951.96**

LED

**IceLED II**

A++-A

incl. 6×4 W  
 6×200 lm, 2.700 K  
 230/12 V, incl. ⚡ 30 VA  
 ⚙️ 30 mm ↔ 3 m  
 EAN 4000870 951972  
**951.97**

LED



- 🔗 Weiß/Chrom 📦 Metall/Glas
- 🔗 Blanc/Chrome 📦 Métal/Verre
- 🔗 Wit/Chroom 📦 Metaal/Glas

**Stage**

A++-A

incl. 4×5 W  
 4×300 lm, 2.700 K  
 230 V, incl. ⚡ 30 VA  
 ⚙️ 30 mm ↔ 2,1 m  
 EAN 4000870 950777  
**950.77**

LED





# Function

- 178 MaxLED
- 192 YourLED
- 222 Profile
- 232 CabinetLight



230 Socle Profil



187 MaxLED RGBW





- ▶ MaxLED LED-Strips eröffnen durch ihre große Leuchtkraft völlig neuartige Ideen für allgemeines Raum- und Arbeitslicht
- ▶ Eine dichte LED Bestückung sorgt für ein kontinuierliches Lichtbild - ideal zur Verarbeitung in Profilen
- ▶ 1m Strip MaxLED 1000 entspricht in etwa der Lichtwirkung einer 75 W Glühlampe
- ▶ MaxLED wird in erweiterungsfähigen Basissets in wohnlichem Warmweiß - 2700 K, Tageslichtweiß - 6500 K oder als RGB-Farbwechsel mit Fernbedienung angeboten
- ▶ Licht zum Aufkleben: Dank rückseitigem Klebestreifen ohne Werkzeug schnell verlegt
- ▶ Grâce à leur forte intensité lumineuse, les rubans LED MaxLED ouvrent tout un nouveau monde de possibilités pour l'éclairage de travail et l'éclairage d'intérieur
- ▶ La grande densité de LED diffuse un halo de lumière continue - idéal pour l'installation dans des profilés
- ▶ Un ruban MaxLED 1000 d'1 m permet d'obtenir le même effet de lumière qu'une ampoule à incandescence de 75 W
- ▶ MaxLED est disponible avec une télécommande en kit de base extensible dans un blanc chaud agréable - 2700 K, un blanc lumière du jour - 6500 K ou un changement de couleur RGB
- ▶ Éclairage à coller : pose rapide sans outil grâce au ruban adhésif double-face
- ▶ MaxLED ledstrips creëren door hun grote lichtkracht volledig nieuwe ideeën voor algemeen ruimte- en werklicht
- ▶ Vele leds zorgen voor een continu lichtbeeld - optimaal voor verwerking in profielen
- ▶ 1 m strip MaxLED 1000 komt qua lichtsterkte overeen met een 75 W gloeilamp
- ▶ MaxLED wordt aangeboden in uitbreidbare basissets in aangenaam warm wit - 2700 K, daglichtwit - 6500 K of als RGB-kleurwissel met afstandsbediening
- ▶ Licht om vast te plakken: dankzij hechtstrips aan de achterzijde zonder gereedschap snel gemonteerd

MaxLED Tunable White





MaxLED 500  
2700 K

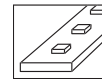

- 🔗 Silber 📏 Metall
- 🔗 Argent 📏 Métal
- 🔗 Zilver 📏 Metaal



**Strip Warm white 1m**

incl. 1x7 W  
550 lm, 2.700 K  
DC 24 V  
⌀3 mm ⌀12,5 mm ↔1 m  
EAN 4000870 705810  
**705.81**



**Strip Warm white 2,5m**

incl. 1x16 W  
1.375 lm, 2.700 K  
24 V  
⌀3 mm ⌀12,5 mm ↔2,5 m  
EAN 4000870 708279  
**708.27**



**Basic Set Warm white 1,5m expanded max. 3m**

incl. 1x10 W  
825 lm, 2.700 K  
230/24 V, incl. ⚡20 VA  
⌀3 mm ⌀12,5 mm ↔1,5-3 m  
EAN 4000870 705773  
**705.77**



**Basic Set Warm white 3m expanded 5,5 m**

incl. 1x20 W  
1.650 lm, 2.700 K  
230/24 V, incl. ⚡36 VA  
⌀3 mm ⌀12,5 mm ↔3-5,5 m  
EAN 4000870 705797  
**705.79**



**Basic Set Warm white 5m expanded max. 16,5m**

incl. 1x33 W  
2.750 lm, 2.700 K  
230/24 V, incl. ⚡75 VA  
⌀3 mm ⌀12,5 mm ↔5-16,5 m  
EAN 4000870 706046  
**706.04**



**Basic Set Warm white 10m expanded max. 20m**

incl. 1x53,5 W  
5.500 lm, 2.700 K  
230/24 V, incl. ⚡80 VA  
⌀3 mm ⌀12,5 mm ↔10-20 m  
EAN 4000870 708293  
**708.29**



**Basic Set Warm white 10m expanded max. 20m**

incl. 1x53,5 W  
5.500 lm, 2.700 K  
230/24 V, incl. ⚡80 VA  
⌀3 mm ⌀12,5 mm ↔10-20 m  
EAN 4000870 709078  
**709.07 new**

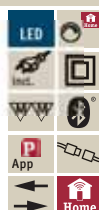

not incl.  
**Remote Control**  
☐= 400





- 🔗 Silber 📏 Metall
- 🔗 Argent 📏 Métal
- 🔗 Zilver 📏 Metaal

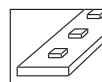

**Strip Daylight 1m** A++-A

incl. 1x6 W  
550 lm, 6.500 K  
DC 24 V  
⌀3 mm ↗12,5 mm ↔1 m  
EAN 4000870 705827  
**705.82** 📦

LED  
incl.  
W/W  
🔗



**Strip Daylight 2,5m** A++-A

incl. 1x14 W  
1.375 lm, 6.500 K  
24 V  
⌀3 mm ↗12,5 mm ↔2,5 m  
EAN 4000870 708286  
**708.28** 📦

LED  
incl.  
W/W  
🔗



**Basic Set Daylight 1,5m expanded 3,5 m** A++-A

incl. 1x8,5 W  
825 lm, 6.500 K  
230/24 V, incl. ⚡ 20 VA  
⌀3 mm ↗12,5 mm ↔1,5-3,5 m  
EAN 4000870 705780  
**705.78** 📦

LED  
incl.  
W/W  
🔗



**Basic Set Daylight 3m expanded 6,5 m** A++-A

incl. 1x17 W  
1.650 lm, 6.500 K  
230/24 V, incl. ⚡ 36 VA  
⌀3 mm ↗12,5 mm ↔3-6,5 m  
EAN 4000870 705803  
**705.80** 📦

LED  
incl.  
W/W  
🔗



**Basic Set Daylight 5m expanded max. 13m** A++-A

incl. 1x28 W  
2.750 lm, 6.500 K  
230/24 V, incl. ⚡ 60 VA  
⌀3 mm ↗12,5 mm ↔5-13 m  
EAN 4000870 706053  
**706.05** 📦

LED  
incl.  
W/W  
🔗

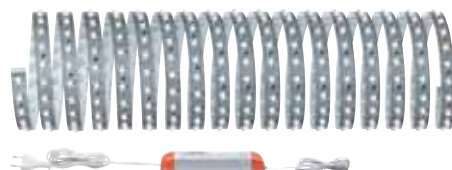

**Basic Set Daylight 10m expanded max. 20m** A++-A

incl. 1x48,5 W  
5.500 lm, 6.500 K  
230/24 V, incl. ⚡ 75 VA  
⌀3 mm ↗12,5 mm ↔10-20 m  
EAN 4000870 708309  
**708.30** 📦

LED  
incl.  
W/W  
🔗



**Basic Set Daylight 10m expanded max. 20m** A++-A

incl. 1x48,5 W  
5.500 lm, 6.500 K  
230/24 V, incl. ⚡ 75 VA  
⌀3 mm ↗12,5 mm ↔10-20 m  
EAN 4000870 709085  
**709.08 new**

LED  
incl.  
W/W  
App  
Home



not incl.  
**Remote Control**  
📏= 400





MaxLED 500

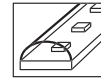

- 🔗 Silber 📦 Kunststoff
- 🔗 Argent 📦 Matière plastique
- 🔗 Zilver 📦 Kunststof



**Strip Warm white 1m**

incl. 1×7 W  
550 lm, 2.700 K  
DC 24 V  
⌀4 mm ⌀12,5 mm ⇄1 m  
EAN 4000870 706633  
**706.63** 📦



**Basic Set Warm white 1,5m expanded max. 3m**

incl. 1×10 W  
825 lm, 2.700 K  
230/24 V, incl. ⚡20 VA  
⌀4 mm ⌀12,5 mm ⇄1,5-3 m  
EAN 4000870 706688  
**706.68** 📦

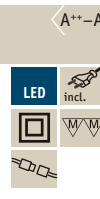

**Basic Set Warm white 3m expanded 5,5 m**

incl. 1×20 W  
1.650 lm, 2.700 K  
230/24 V, incl. ⚡36 VA  
⌀4 mm ⌀12,5 mm ⇄3-5,5 m  
EAN 4000870 706664  
**706.66** 📦

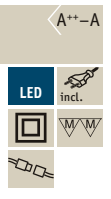

**Basic Set Warm white 1,5m expanded max. 3m Dimm/Switch Controller IR**

incl. 1×10 W  
825 lm, 2.700 K  
230/24 V, incl. ⚡20 VA  
⌀4 mm ⌀12,5 mm ⇄1,5-3 m  
EAN 4000870 708026  
**708.02** 📦



**Basic Set Warm white 3m expanded max. 5,4m Dimm/Switch Controller IR**

incl. 1×20 W  
1.650 lm, 2.700 K  
230/24 V, incl. ⚡36 VA  
⌀4 mm ⌀12,5 mm ⇄3-5,5 m  
EAN 4000870 708033  
**708.03** 📦

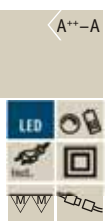

**Strip Daylight 1m**

incl. 1×6 W  
550 lm, 6.500 K  
DC 24 V  
⌀4 mm ⌀12,5 mm ⇄1 m  
EAN 4000870 706640  
**706.64** 📦



**Basic Set Daylight 1,5m expanded 3,5 m**

incl. 1×8,5 W  
825 lm, 6.500 K  
230/24 V, incl. ⚡20 VA  
⌀4 mm ⌀12,5 mm ⇄1,5-3,5 m  
EAN 4000870 706671  
**706.67** 📦



**Basic Set Daylight 3m expanded 6,5 m**

incl. 1×17 W  
1.650 lm, 6.500 K  
230/24 V, incl. ⚡36 VA  
⌀4 mm ⌀12,5 mm ⇄3-6,5 m  
EAN 4000870 706657  
**706.65** 📦

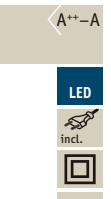

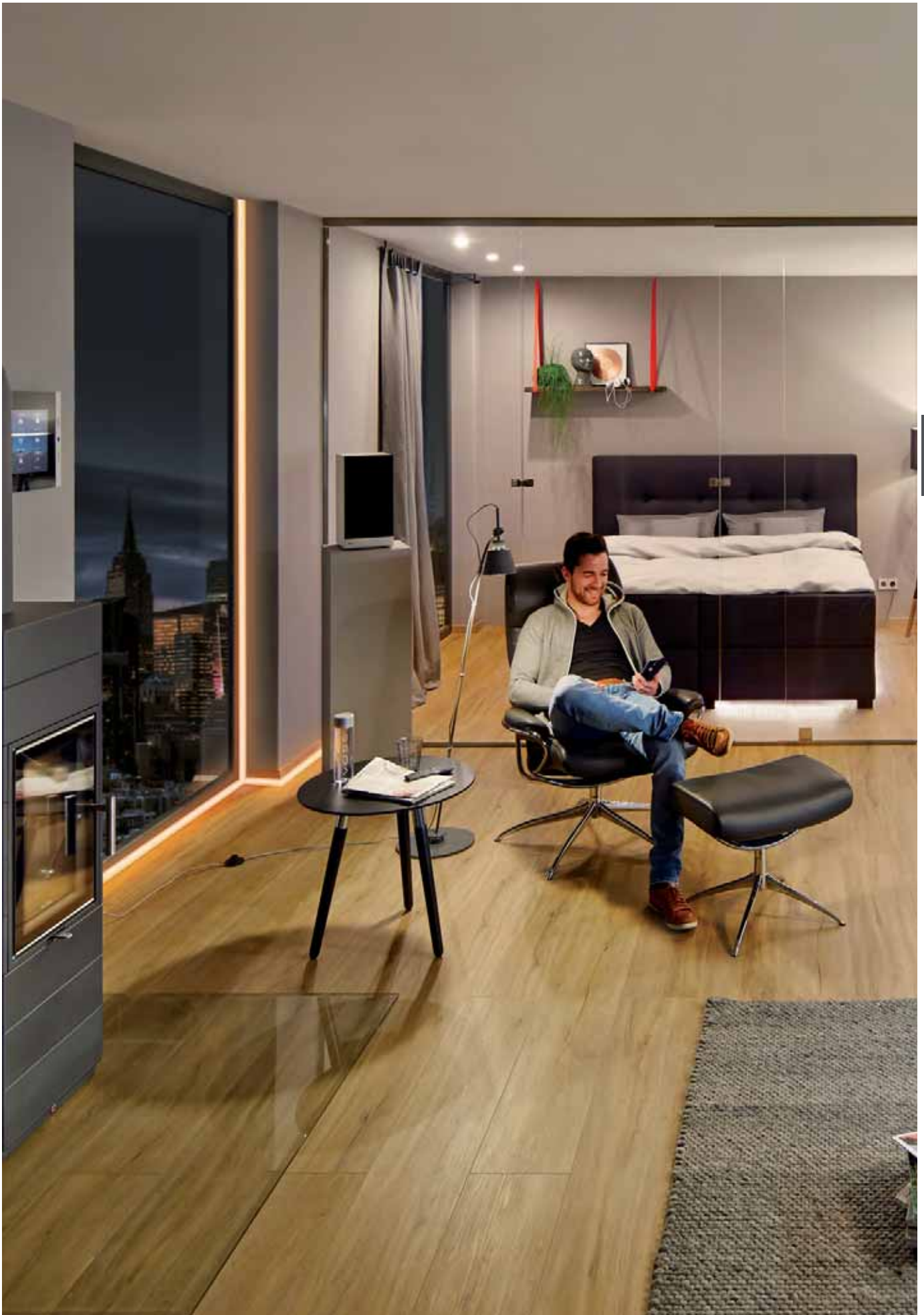

Silber Metall  
 Argent Métal  
 Zilver Metaal

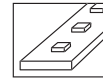

**Strip Warm white 1m**

incl. 1x13,5 W  
 1.100 lm, 2.700 K  
 DC 24 V  
 ⌀3 mm ⌀12,5 mm ⇄1 m  
 EAN 4000870 705681  
**705.68**



**Basic Set Warm white 1,5m expanded max. 5m**

incl. 1x20 W  
 1.650 lm, 2.700 K  
 230/24 V, incl. ⚡ 60 VA  
 ⌀3 mm ⌀12,5 mm ⇄1,5-5 m  
 EAN 4000870 705858  
**705.85**



**Basic Set Warm white 3m expanded max. 7m**

incl. 1x40 W  
 3.300 lm, 2.700 K  
 230/24 V, incl. ⚡ 75 VA  
 ⌀3 mm ⌀12,5 mm ⇄3-7 m  
 EAN 4000870 705889  
**705.88**



**Strip Daylight 1m**

incl. 1x11,5 W  
 1.100 lm, 6.500 K  
 DC 24 V  
 ⌀3 mm ⌀12,5 mm ⇄1 m  
 EAN 4000870 705698  
**705.69**



**Basic Set Daylight 1,5m expanded max. 3m**

incl. 1x17 W  
 1.650 lm, 6.500 K  
 230/24 V, incl. ⚡ 36 VA  
 ⌀3 mm ⌀12,5 mm ⇄1,5-3 m  
 EAN 4000870 705865  
**705.86**



**Basic Set Daylight 3m expanded max. 5,5m**

incl. 1x34 W  
 3.300 lm, 6.500 K  
 230/24 V, incl. ⚡ 60 VA  
 ⌀3 mm ⌀12,5 mm ⇄3-5,5 m  
 EAN 4000870 705896  
**705.89**





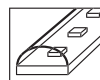

- 🔗 Silber 🧺 Kunststoff
- 🔗 Argent 🧺 Matière plastique
- 🔗 Zilver 🧺 Kunststof



**Strip Warm white 1m**  
 incl. 1x13,5 W  
 1.100 lm, 2.700 K  
 DC 24 V  
 ⌀4 mm ⌀12,5 mm ↔1 m  
 EAN 4000870 706763  
**706.76**



**Basic Set Warm white 1,5m expanded max. 5m**  
 incl. 1x20 W  
 1.650 lm, 2.700 K  
 230/24 V, incl. ⚡60 VA  
 ⌀4 mm ⌀12,5 mm ↔1,5-5 m  
 EAN 4000870 706725  
**706.72**

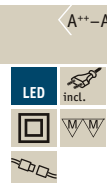

**Basic Set Warm white 3m expanded max. 7m**  
 incl. 1x40 W  
 3.300 lm, 2.700 K  
 230/24 V, incl. ⚡75 VA  
 ⌀4 mm ⌀12,5 mm ↔3-7 m  
 EAN 4000870 706701  
**706.70**



**Basic Set Warm white 1,5m expanded max. 5m Dimm/Switch Controller IR**  
 incl. 1x20 W  
 1.650 lm, 2.700 K  
 230/24 V, incl. ⚡60 VA  
 ⌀4 mm ⌀12,5 mm ↔1,5-5 m  
 EAN 4000870 708002  
**708.00**



**Basic Set Warm white 3m expanded max. 7m Dimm/Switch Controller IR**  
 incl. 1x40 W  
 3.300 lm, 2.700 K  
 230/24 V, incl. ⚡75 VA  
 ⌀4 mm ⌀12,5 mm ↔3-7 m  
 EAN 4000870 708019  
**708.01**



**Strip Daylight 1m**  
 incl. 1x11,5 W  
 1.100 lm, 6.500 K  
 DC 24 V  
 ⌀4 mm ⌀12,5 mm ↔1 m  
 EAN 4000870 706756  
**706.75**



**Basic Set Daylight 1,5m expanded max. 3m**  
 incl. 1x17 W  
 1.650 lm, 6.500 K  
 230/24 V, incl. ⚡36 VA  
 ⌀4 mm ⌀12,5 mm ↔1,5-3 m  
 EAN 4000870 706718  
**706.71**



**Basic Set Daylight 3m expanded max. 5,5m**  
 incl. 1x34 W  
 3.300 lm, 6.500 K  
 230/24 V, incl. ⚡60 VA  
 ⌀4 mm ⌀12,5 mm ↔3-5,5 m  
 EAN 4000870 706695  
**706.69**



- 🔗 Silber 🏠 Metall
- 🔗 Argent 🏠 Métal
- 🔗 Zilver 🏠 Metaal

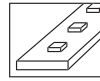

**Strip RGB 1m**

incl. 1x13,5 W  
 420 lm  
 DC 24 V  
 ⌀3 mm ↗12,5 mm ↔1 m  
 EAN 4000870 705704  
**705.70** 🏠

A++-A

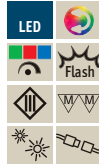

**Basic Set RGB 1,5m  
 expanded max. 3m**

incl. 1x20 W  
 630 lm  
 230/24 V, incl. ⚡ 36 VA  
 ⌀3 mm ↗12,5 mm ↔1,5-3 m  
 EAN 4000870 705872  
**705.87** 🏠

A++-A

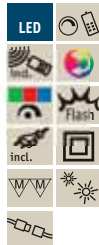

**Basic Set RGB 3m  
 expanded max. 5m**

incl. 1x40 W  
 1.260 lm  
 230/24 V, incl. ⚡ 60 VA  
 ⌀3 mm ↗12,5 mm ↔3-5 m  
 EAN 4000870 705674  
**705.67** 🏠

A++-A

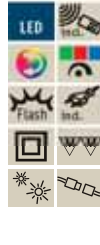

- 🔗 Silber 📦 Kunststoff
- 🔗 Argent 📦 Matière plastique
- 🔗 Zilver 📦 Kunststof

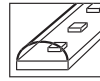

**Strip RGB 1m**

incl. 1x13,5W  
 420 lm  
 DC 24 V  
 ⌀4 mm ⌀12,5 mm ⇄1 m  
 EAN 4000870 706572  
**706.57** 📦

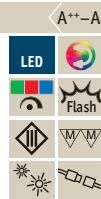

**Basic Set RGB 1,5m  
 expanded max. 3m**

incl. 1x20 W  
 630 lm  
 230/24 V, incl. ⚡ 36 VA  
 ⌀4 mm ⌀12,5 mm ⇄1,5-3 m  
 EAN 4000870 706749  
**706.74** 📦

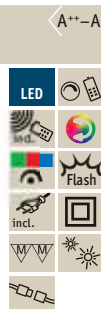

**Basic Set RGB 3m  
 expanded max. 5m**

incl. 1x40 W  
 1.260 lm  
 230/24 V, incl. ⚡ 60 VA  
 ⌀4 mm ⌀12,5 mm ⇄3-5 m  
 EAN 4000870 706732  
**706.73** 📦

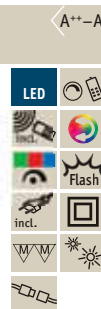

- 🔗 Silber 📦 Kunststoff
- 🔗 Argent 📦 Matière plastique
- 🔗 Zilver 📦 Kunststof

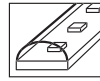
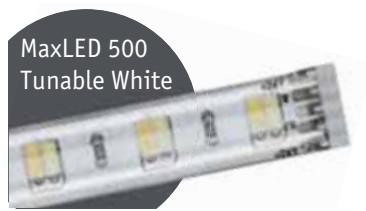

**Strip 1m Tunable White**

A++-A

incl. 1x7 W  
 550-580 lm, 2.700 - 6.500 K  
 ✗ 120°  
 DC 24 V  
 ⚙️ 3 mm ⚙️ 12,5 mm ↔ 1 m  
 EAN 4000870 706305  
**706.30** 📦

- LED
- tunable white
- 📏
- ⚡
- 🔗



**Basic Set 1,5m Tunable White - max. exp. 3m**

A++-A

incl. 1x10 W  
 720-750 lm, 2.700 - 6.500 K  
 ✗ 120°  
 230/24 V, incl. ⚡ 20 VA  
 ⚙️ 3 mm ⚙️ 12,5 mm ↔ 1,5-3 m  
 EAN 4000870 706237  
**706.23** 📦

- LED
- tunable white
- 📏
- ⚡
- 🔗

**Basic Set 3m Tunable White - max. exp. 5m**

A++-A

incl. 1x20 W  
 1.650-1.740 lm, 2.700 - 6.500 K  
 ✗ 120°  
 230/24 V, incl. ⚡ 36 VA  
 ⚙️ 3 mm ⚙️ 12,5 mm ↔ 3-5 m  
 EAN 4000870 706244  
**706.24** 📦

- LED
- tunable white
- 📏
- ⚡
- 🔗

- 🔗 Silber 📦 Kunststoff
- 🔗 Argent 📦 Matière plastique
- 🔗 Zilver 📦 Kunststof



**Strip 1m RGBW**

incl. 1x12 W  
 3.000 K  
 ✎ 120°  
 DC 24 V  
 ⚙ 3 mm ⚙ 12,5 mm ↔ 1 m  
 EAN 4000870 706343  
**706.34**

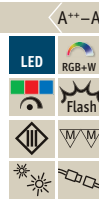

**Basic Set 1,5m RGBW - max. exp. 3m**

incl. 1x18 W  
 580+630 lm, 3.000 K  
 ✎ 120°  
 230/24 V, incl. ⚡ 36 VA  
 ⚙ 3 mm ⚙ 12,5 mm ↔ 1,5-3 m  
 EAN 4000870 706275  
**706.27**

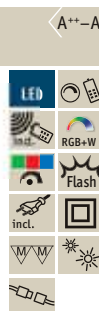

**Basic Set 3m RGBW - max. exp. 6m**

incl. 1x36 W  
 1.160+1.260 lm, 3.000 K  
 ✎ 120°  
 230/24 V, incl. ⚡ 60 VA  
 ⚙ 3 mm ⚙ 12,5 mm ↔ 3-6 m  
 EAN 4000870 706282  
**706.28**



- ↳ Weiß 田 Kunststoff
- ↳ Blanc 田 Matière plastique
- ↳ Wit 田 Kunststof



**Flex-Connector 10cm**

⌀6 ⇔100 ↗15 mm  
 EAN 4000870 705766  
**705.76** 📦



**Flex-Connector 1m**

⌀6 mm ↗15 mm ⇔1 m  
 EAN 4000870 705759  
**705.75** 📦



**Flex-Connector 5m**

⌀6 mm ↗15 mm ⇔5 m  
 EAN 4000870 705742  
**705.74** 📦



4x

8x

**MaxLED Edge-Connector**

max. 144 W  
 ⌀12 ⇔17 ↗16 mm  
 EAN 4000870 706152  
**706.15** 📦



4x

8x

**MaxLED Edge-Connector 90°**

max. 144 W  
 ⌀4,5 ⇔25 ↗25 mm  
 EAN 4000870 706169  
**706.16** 📦



1x

**MaxLED X-Connector**

max. 144 W  
 ⌀6 ⇔32 ↗28 mm  
 EAN 4000870 706176  
**706.17** 📦



**MaxLED Clip-to-Clip Connector**

max. 144 W  
 ⌀4,5 ⇔20 ↗13,5 mm  
 EAN 4000870 706183  
**706.18** 📦

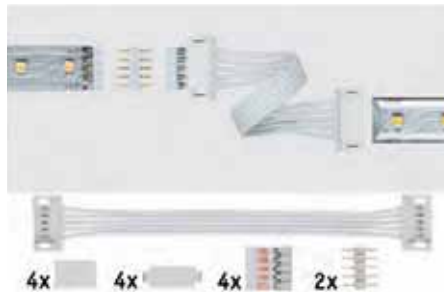

4x

4x

4x

2x

**Universal MaxLED Connector**

max. 144 W  
 ⌀7 ⇔100 ↗19 mm  
 EAN 4000870 709191  
**709.19** 📦 **new**



Universal MaxLED  
 Connector 709.19  
 Fits only in  
 Corner & Deep Profil

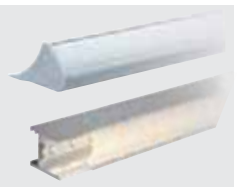

**Power Supply 230/24V DC**

max. 36 W  
 230/24 V, incl. ⚡ 36 VA  
 ⌀24 ⇔166 ↗52 mm  
 EAN 4000870 708231  
**708.23** 📦



- ↳ Weiß 田 Kunststoff
- ↳ Blanc 田 Matière plastique
- ↳ Wit 田 Kunststof



**Power Supply 230/24V DC**

max. 60 W  
 230/24 V, incl. ⚡ 60 VA  
 ⌀35 ⇔175 ↗54 mm  
 EAN 4000870 708248  
**708.24** 📦



- ↳ Weiß 田 Kunststoff
- ↳ Blanc 田 Matière plastique
- ↳ Wit 田 Kunststof

- ▶ Zum Schalten oder Dimmen einzelner MaxLED Strips
- ▶ Fernbedienung auch als praktische Funkausführung 2,4 GHz

- ▶ Pour commuter ou faire varier l'intensité de rubans MaxLED individuels
- ▶ Télécommande également disponible en version radio 2,4 GHz

- ▶ Voor het schakelen of dimmen van afzonderlijke MaxLED-strips
- ▶ Afstandsbediening ook als praktische radio-uitvoering 2,4 GHz



**Dimm/Switch Controller IR**

max. 144 W  
 CR 2025 x 1  
 DC 24 V  
 ⌀22 ⇄50 ↗35 mm  
 EAN 4000870 706831  
**706.83**



**RGB-Controller 2.4GHz**

max. 144 W  
 AAA/1,5V (Micro) x 2  
 DC 24 V  
 ⌀22,5 ⇄85 ↗45 mm  
 EAN 4000870 706213  
**706.21**



**Dimm/Switch-Controller 2.4GHz**

max. 144 W  
 AAA/1,5V (Micro) x 2  
 DC 24 V  
 ⌀22,5 ⇄85 ↗45 mm  
 EAN 4000870 706190  
**706.19**



**RGBW-Controller 2.4GHz**

max. 144 W  
 AAA/1,5V (Micro) x 2  
 DC 24 V  
 ⌀20 ⇄110 ↗53 mm  
 EAN 4000870 797976  
**797.97 new**



- ▶ Zur Verstärkung des Steuerungssignals vom MaxLED Controller

- ▶ Permet d'amplifier le signal de commande de la commande MaxLED

- ▶ Voor versterking van het stuursignaal van MaxLED-regelaar



**Mono Color Amplifier**

max. 144 W  
 DC 24 V  
 ⌀24 ⇄105 ↗65 mm  
 EAN 4000870 706848  
**706.84**



- ☞ Alu matt ☒ Metall
- ☞ Alu mat ☒ Métal
- ☞ Alu mat ☒ Metaal



for MaxLED RGB Stripe

**RGB Amplifier**

max. 144 W  
 DC 24 V  
 ⌀24 ⇄105 ↗65 mm  
 EAN 4000870 706855  
**706.85**



- ☞ Alu matt ☒ Metall
- ☞ Alu mat ☒ Métal
- ☞ Alu mat ☒ Metaal

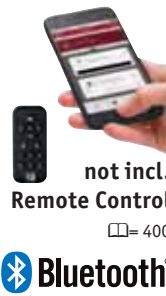

- ↳ Weiß 田 Kunststoff
- ↳ Blanc 田 Matière plastique
- ↳ Wit 田 Kunststof



### Switch/Dimm Controller

max. 144 W  
DC 24 V  
⌀19 ⇄39 ↗80 mm  
EAN 4000870 500026  
**500.02**

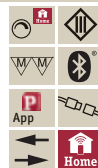

### TunableWhite Controller

max. 144 W  
DC 24 V  
⌀19 ⇄39 ↗80 mm  
EAN 4000870 500033  
**500.03**



### RGBW Controller

max. 144 W  
DC 24 V  
⌀19 ⇄39 ↗80 mm  
EAN 4000870 500040  
**500.04**



- ↳ Weiß/Grau 田 Kunststoff
- ↳ Blanc/Gris 田 Matière plastique
- ↳ Wit/Grijs 田 Kunststof



### Switch/Dimm Controller

max. 144 W  
DC 24 V  
⌀28 ⇄38 ↗95 mm  
EAN 4000870 500453  
**500.45**

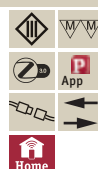

### Tunable White Controller

max. 144 W  
DC 24 V  
⌀28 ⇄38 ↗95 mm  
EAN 4000870 500460  
**500.46**

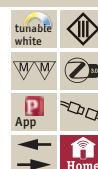

### RGBW Controller

max. 72 W  
DC 24 V  
⌀28 ⇄38 ↗95 mm  
EAN 4000870 500477  
**500.47**

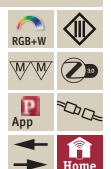



## YourLED Strip

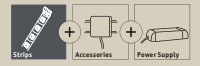

## Accessories

☰ = 196 »



## Power Supply

☰ = 198

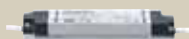
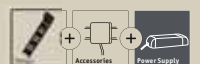

Power Supply 15 W 230/12 V DC



Power Supply 48 W 230/12 V DC



Power Supply 60 W 230/12 V DC

## YourLED ECO Strip

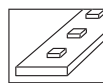
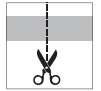
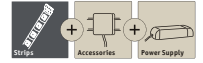

- 🔗 Schwarz 🏠 Metall
- 🔗 Noir 🏠 Métal
- 🔗 Zwart 🏠 Metaal

Accessories  
📦 = 196-205



### ECO Strip RGB 1m

incl. 1x6 W  
110 lm  
∠ 120°  
DC 12 V  
⌀2,5 mm ⌀10,5 mm ⇄1 m  
EAN 4000870 704608  
**704.60** 📦



### ECO Strip RGB 3m

incl. 1x14,5 W  
330 lm  
∠ 120°  
DC 12 V  
⌀2,5 mm ⌀10,5 mm ⇄3 m  
EAN 4000870 702529  
**702.52** 📦



### ECO Strip RGB 5m

incl. 1x18 W  
550 lm  
∠ 120°  
DC 12 V  
⌀2,5 mm ⌀10,5 mm ⇄5 m  
EAN 4000870 702536  
**702.53** 📦



### ECO Basic Set RGB 3m expanded max. 5m

incl. 1x14,5 W  
330 lm  
∠ 120°  
230/12 V, incl. - 24 VA  
⌀2,5 mm ⌀10,5 mm ⇄3-5 m  
EAN 4000870 704301  
**704.30** 📦

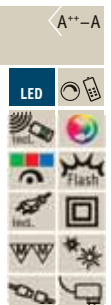

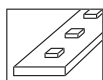

- 👉 Weiß 🗪 Metall
- 👉 Blanc 🗪 Métal
- 👉 Wit 🗪 Metaal

Accessories  
📖 = 196-205



**ECO Strip Warm white 1m** A++-A

incl. 1x2,4 W  
160 lm, 3.000 K  
✗ 120°  
DC 12 V  
⇅ 2,5 mm ⇅ 10,5 mm ⇄ 1 m  
EAN 4000870 704592  
**704.59** 📦

LED

👉

🔌

🔌

🔌

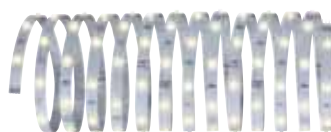
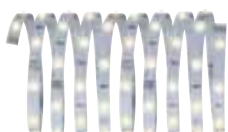

**ECO Strip Warm white 3m** A++-A

incl. 1x6,8 W  
480 lm, 3.000 K  
✗ 120°  
DC 12 V  
⇅ 2,5 mm ⇅ 10,5 mm ⇄ 3 m  
EAN 4000870 702543  
**702.54** 📦

LED

👉

🔌

🔌

🔌

**ECO Strip Warm white 5m** A++-A

incl. 1x10,5 W  
780 lm, 3.000 K  
✗ 120°  
DC 12 V  
⇅ 2,5 mm ⇅ 10,5 mm ⇄ 5 m  
EAN 4000870 702550  
**702.55** 📦

LED

👉

🔌

🔌

🔌

**ECO Basic Set Warm white 3m expanded max. 5m** A++-A

incl. 1x6,8 W  
480 lm, 3.000 K  
✗ 120°  
230/12 V, incl. ⚡ 12 VA  
⇅ 2,5 mm ⇅ 10,5 mm ⇄ 3-6 m  
EAN 4000870 704288  
**704.28** 📦

LED

incl. 👉

🔌

🔌

🔌

🔌



**ECO Strip Neutral white 1m** A++-A

incl. 1x2,4 W  
180 lm, 4.000 K  
✗ 120°  
DC 12 V  
⇅ 2,5 mm ⇅ 10,5 mm ⇄ 1 m  
EAN 4000870 704585  
**704.58** 📦

LED

👉

🔌

🔌

🔌



**ECO Strip Neutral white 3m** A++-A

incl. 1x6,8 W  
540 lm, 4.000 K  
✗ 120°  
DC 12 V  
⇅ 2,5 mm ⇅ 10,5 mm ⇄ 3 m  
EAN 4000870 702574  
**702.56** 📦

LED

👉

🔌

🔌

🔌

**ECO Strip Neutral white 5m** A++-A

incl. 1x10,5 W  
900 lm, 4.000 K  
✗ 120°  
DC 12 V  
⇅ 2,5 mm ⇅ 10,5 mm ⇄ 5 m  
EAN 4000870 702574  
**702.57** 📦

LED

👉

🔌

🔌

🔌

**ECO Basic Set Neutral white 3m expanded max. 5m** A++-A

incl. 1x6,8 W  
540 lm, 4.000 K  
✗ 120°  
230/12 V, incl. ⚡ 12 VA  
⇅ 2,5 mm ⇅ 10,5 mm ⇄ 3-6 m  
EAN 4000870 704295  
**704.29** 📦

LED

incl. 👉

🔌

🔌

🔌

🔌

## YourLED Strip

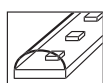
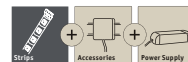

- ↳ Schwarz 田 Kunststoff
- ↳ Noir 田 Matière plastique
- ↳ Zwart 田 Kunststof

Accessories  
 □ = 196-205



### Strip RGB 98cm

incl. 1x7W  
 184 lm  
 ∠ 120°  
 DC 12V  
 ⌀3 mm ⇄975 mm ⇄10,5 mm  
 ⇄1 m  
 EAN 4000870 702109  
**702.10**

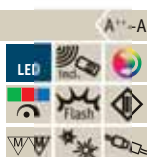

### Strip RGB 3m

incl. 1x17,8W  
 184 lm  
 ∠ 120°  
 DC 12V  
 ⌀3 mm ⇄10,5 mm ⇄3 m  
 EAN 4000870 705940  
**705.94**

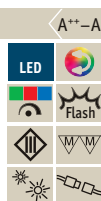

### Basic Set RGB 1,5m expanded max. 2,5m

incl. 1x10W  
 275 lm  
 ∠ 120°  
 230/12V, incl. 18VA  
 ⌀3 mm ⇄10,5 mm ⇄1,5-3 m  
 EAN 4000870 703199  
**703.19**

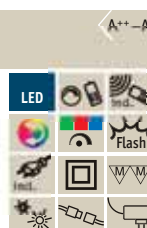

### Basic Set RGB 3m expanded max. 5m

incl. 1x17,8W  
 550 lm  
 ∠ 120°  
 230/12V, incl. 24VA  
 ⌀3 mm ⇄10,5 mm ⇄3-5 m  
 EAN 4000870 703229  
**703.22**

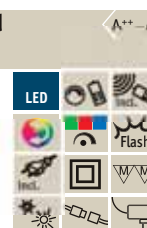

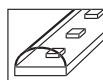

- 🔧 Weiß 📦 Kunststoff
- 🔧 Blanc 📦 Matière plastique
- 🔧 Wit 📦 Kunststof

Accessories  
📖 = 196-205



**Strip Warm white 97cm**

incl. 1x3 W  
265 lm, 3.000 K  
✗ 120°  
DC 12 V  
⌀3 mm ⇄975 mm ↗10,5 mm ⇄1 m  
EAN 4000870 702086  
**702.08**

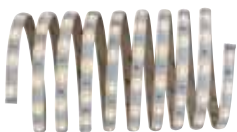

**Strip Warm white 3m**

incl. 1x7,5 W  
800 lm, 3.000 K  
✗ 120°  
DC 12 V  
⌀3 mm ↗10,5 mm ⇄3 m  
EAN 4000870 705926  
**705.92**



**Basic Set Warm white 1,5m expanded max. 4,8m**

incl. 1x4,5 W  
400 lm, 3.000 K  
230/12 V, incl. ⚡ 12 VA  
⌀3 mm ↗10,5 mm ⇄1,5-4,8 m  
EAN 4000870 703175  
**703.17**



**Basic Set Warm white 3m expanded max. 7,5m**

incl. 1x7,5 W  
800 lm, 3.000 K  
230/12 V, incl. ⚡ 18 VA  
⌀3 mm ↗10,5 mm ⇄3-7,5 m  
EAN 4000870 703205  
**703.20**



**Strip Daylight 97cm**

incl. 1x3 W  
270 lm, 6.000 K  
✗ 120°  
DC 12 V  
⌀3 mm ⇄975 mm ↗10,5 mm ⇄1 m  
EAN 4000870 702093  
**702.09**



**Strip Daylight 3m**

incl. 1x7,5 W  
810 lm, 6.000 K  
✗ 120°  
DC 12 V  
⌀3 mm ↗10,5 mm ⇄3 m  
EAN 4000870 705933  
**705.93**



**Basic Set Daylight 1,5m expanded max. 4,8m**

incl. 1x4,5 W  
405 lm, 6.000 K  
230/12 V, incl. ⚡ 12 VA  
⌀3 mm ↗10,5 mm ⇄1,5-4,8 m  
EAN 4000870 703182  
**703.18**



**Basic Set Daylight 3m expanded max. 7,5m**

incl. 1x7,5 W  
810 lm, 6.000 K  
230/12 V, incl. ⚡ 18 VA  
⌀3 mm ↗10,5 mm ⇄3-7,5 m  
EAN 4000870 703212  
**703.21**



for  
RGB Color  
□ = 192, 194



Power Supply

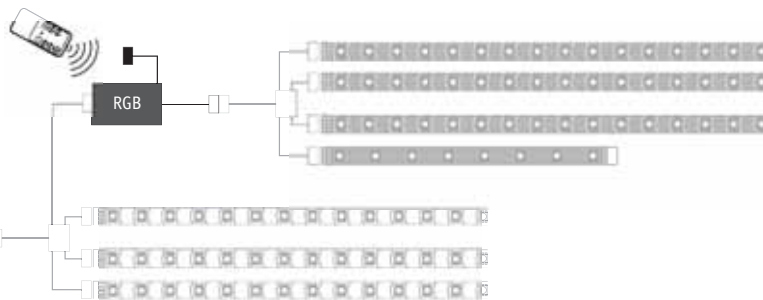

■ Kunststoff  
■ Matière plastique  
■ Kunststof

- ▶ Notwendig zur Ansteuerung von YourLED und YourLED ECO RGB-Streifen
- ▶ IR-Fernbedienung mit freier Wahl voreingestellter Farben sowie zur Feinjustierung der einzelnen Farbkanäle nach Bedarf. 4 Programme (Farbwechsel, Stroboskop,...)
- ▶ Dreistufig dimmbar.
- ▶ Indispensable pour la commande de YourLED ECO et YourLED ECO RGB
- ▶ Télécommande avec couleurs pré réglées au choix et réglage fin des canaux de couleur en fonction des besoins. 4 programmes (changement de couleurs/ stroboscope, etc.)
- ▶ Gradateur 3 niveaux.
- ▶ Vereist voor de besturing van YourLED en YourLED ECO RGB-strips
- ▶ IR-afstandsbediening met vrije keuze van voorinstelde kleuren alsook voor de justering van de afzonderlijke kleurkanalen naar behoefte. 4 programma's (kleurwissel, stroboscoop,...)
- ▶ Drietraps dimbaar.

**RGB-Controller 12V DC**

max. 60 W  
CR 2025 × 1  
DC 12 V  
⌀22 ⇄60 ⌀35 mm  
EAN 4000870 702024  
**702.02**



for  
RGB Color  
□ = 192, 194

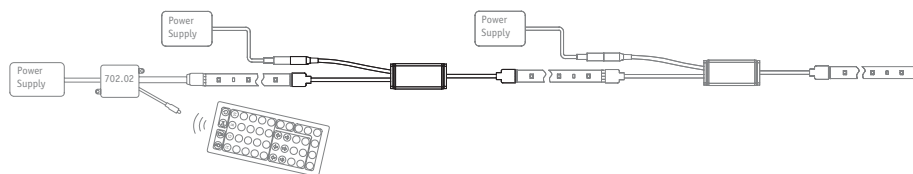

↳ Weiß ■ Kunststoff  
↳ Blanc ■ Matière plastique  
↳ Wit ■ Kunststof

- ▶ Zur Verstärkung des Steuerungssignals vom YourLED RGB-Controller Art. 702.02.
- ▶ So lassen sich über eine Fernbedienung größere YourLED RGB- oder YourLED ECO RGB-Strip-Systeme synchron steuern.
- ▶ Über jeden Verstärker wird ein zusätzlicher Power Supply angeschlossen, um die Systemleistung zu erhöhen
- ▶ Permet d'amplifier le signal de commande de la commande YourLED RGB, art. 702.02.
- ▶ À l'aide d'une télécommande, il est possible de commander simultanément des systèmes de ruban YourLED ECO RGB ou YourLED de plus grande taille.
- ▶ Une alimentation électrique supplémentaire est branchée sur chaque amplificateur pour augmenter la puissance du système
- ▶ Voor versterking van het stuursignaal van YourLED RGB-regelaar art. 702.02.
- ▶ Zo kunnen met een afstandsbediening grotere YourLED of YourLED ECO RGB-stripsystemen synchron worden gestuurd.
- ▶ Via elke versterker wordt een aanvullende Power Supply aangesloten, om het systeemvermogen te verhogen

**RGB Amplifier**

max. 60 W  
DC 12 V  
⌀8 ⇄51 ⌀27 mm  
EAN 4000870 709122  
**709.12** new



for  
Strip  
□ 193, 195

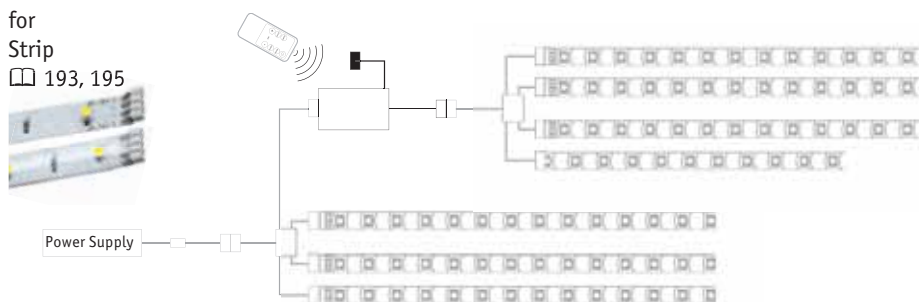

- ↳ Weiß □ Kunststoff
- ↳ Blanc □ Matière plastique
- ↳ Wit □ Kunststof

- ▶ Zum Schalten oder Dimmen einfarbiger YourLED, YourLED ECO oder DECO Strips
- ▶ Der Controller mit Fernbedienung bietet Komfort und begeistert durch angenehmes dimmbares Stimmungslicht
- ▶ Pour commuter ou varier l'intensité des rubans monocouleurs YourLED, YourLED ECO ou DECO Strips
- ▶ Avec sa télécommande, le contrôleur offre un grand confort d'utilisation et enthousiasme par son agréable éclairage d'ambiance à intensité variable.
- ▶ Voor het schakelen of dimmen van eenkleurige YourLED, YourLED ECO of DECO Strips
- ▶ De controller met afstandsbediening biedt comfort en overtuigt door aangename dimbare sfeerverlichting.



**Dimm/Switch Controller IR**

max. 60 W  
CR 2025 × 1  
DC 12 V  
∅22 ⇔ 63 ⇔ 35 mm  
EAN 4000870 704615  
**704.61**



for  
Strip  
□ 193, 195

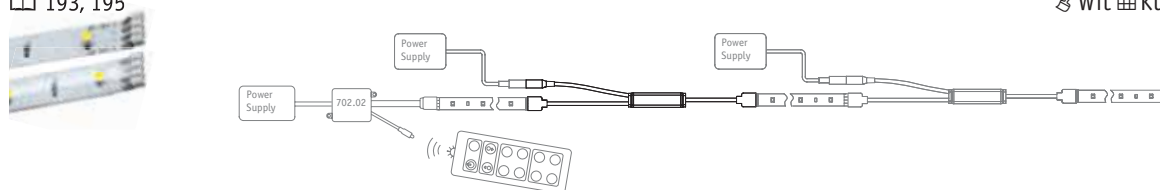

- ↳ Weiß □ Kunststoff
- ↳ Blanc □ Matière plastique
- ↳ Wit □ Kunststof

- ▶ Zur Verstärkung des Steuerungssignals vom YourLED Dimm/Schalt-Controller Art. 704.61
- ▶ So lassen sich über eine Fernbedienung größere einfarbige YourLED, YourLED ECO oder DECO Strip-Systeme synchron dimmen oder schalten
- ▶ Über jeden Verstärker wird ein zusätzlicher Power Supply angeschlossen, um die Systemleistung zu erhöhen
- ▶ Permet d'amplifier le signal de commande du contrôleur de variation et de commutation YourLED, réf. 704.61
- ▶ Avec la télécommande, vous pouvez simultanément commuter ou varier l'intensité des systèmes de ruban YourLED, YourLED ECO ou DECO de plus grande taille
- ▶ Une alimentation électrique supplémentaire est branchée sur chaque amplificateur pour augmenter la puissance du système
- ▶ Ter versterking van het stuursignaal van de YourLED dim/schakel-controller art. 704.61
- ▶ Zo kunnen grotere eenkleurige YourLED, YourLED ECO of DECO Strip-systemen synchron worden gedimd of geschakeld met een afstandsbediening
- ▶ Via elke versterker wordt een aanvullende Power Supply aangesloten, om het systeemvermogen te verhogen



**Mono Color Amplifier**

max. 60 W  
DC 12 V  
∅8 ⇔ 50 ⇔ 15 mm  
EAN 4000870 709115  
**709.11** new



Maximum total length of your system:	15W	48W		60W	
	→	→	↔	→	↔
YourLED	5 m	10 m	20 m (10 m + 10 m)	12 m	24 m (12 m + 12 m)
YourLED ECO	6 m	12,5 m	25 m (12,5 m + 12,5 m)	15 m	30 m (15 m + 15 m)
YourLED RGB	2 m	4 m	8 m (4 m + 4 m)	5 m	10 m (5 m + 5 m)
YourLED ECO RGB	2,5 m	6 m	12 m (6 m + 6 m)	8 m	16 m (8 m + 8 m)

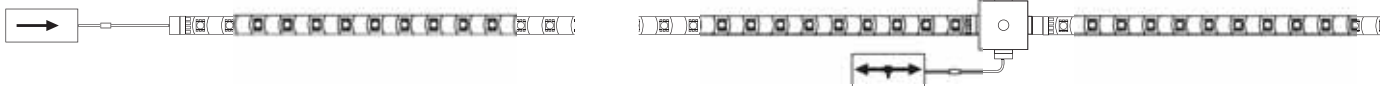

→ Maximale Länge für direkt hintereinander gesteckte Strips.

→ Longueur maximale de strips branchés successivement.

→ Maximale lengte voor direct achter elkaar ingestoken Strips.

↔ Der erste Wert in Klammern unter der Gesamtlänge gibt die maximale Strecke an, die direkt mit dem Trafo angeschlossen werden kann. Für die volle Länge, benötigen Sie zusätzlich eine Junction-Box oder einen X-Connector, um die Leistung zu verteilen. Bei weiteren Abzweigungen wird die Gesamtlänge kürzer. Summieren Sie die einzelnen Watt-Werte der Strips, um die Trafogröße zu ermitteln.

↔ La première valeur entre parenthèses sous la longueur totale indique la longueur maximale qui peut être raccordée directement avec le transformateur. Pour toute la longueur, il est nécessaire de disposer d'une boîte de jonction ou d'un connecteur en croix pour répartir la puissance. La longueur totale sera plus courte sur d'autres dérivations. Cumulez toutes les valeurs en watts des rubans pour déterminer la taille du transformateur.

↔ De eerste waarde tussen haakjes onder de totale lengte geeft de maximale afstand aan die direct met de trafo kan worden aangesloten. Om het vermogen over de volledige lengte te verdelen heeft u bovendien een Junction-Box of een X-Connector nodig. In het geval van nog meer aftakkingen wordt de totale lengte korter. Tel de afzonderlijke watt-waarden van de strips samen om de trafogrootte te bepalen.

- 🌀 Grau/Schwarz 🧱 Kunststoff
- 🌀 Gris/Noir 🧱 Matière plastique
- 🌀 Grijs/Zwart 🧱 Kunststof



**Power Supply 230/12V DC**

max. 15 W  
230/12 V, incl. ⚡ 15 VA  
⌀18 ↔125 ⚡40 mm  
EAN 4000870 701997  
**701.99** 📦



**Power Supply 230/12V DC**

max. 48 W  
230/12 V, incl. ⚡ 48 VA  
⌀40 ↔135 ⚡55 mm  
EAN 4000870 702000  
**702.00** 📦



**Power Supply 60W 230/12V DC IP65**

max. 60 W  
230/12 V, incl. ⚡ 60 VA  
⌀40 ↔225 ⚡60 mm  
EAN 4000870 702017  
**702.01** 📦

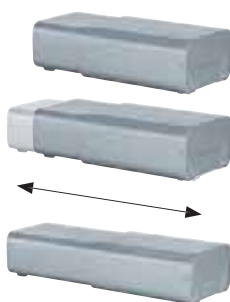
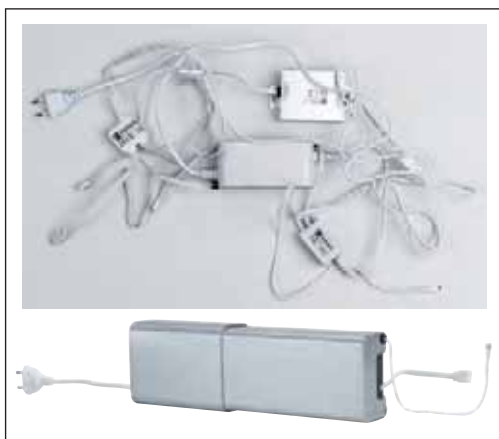

**Trafobox**

⌀58 ↔96 ⚡208-308 mm  
EAN 4000870 705919  
**705.91** 📦

- 🌀 Chrom matt 🧱 Kunststoff/Alu
- 🌀 Chrome mat 🧱 Matière plastique/Alu
- 🌀 Chroom mat 🧱 Kunststof/Alu





 10°  
50-10mm  
on/off

 Weiß  Kunststoff  
 Blanc  Matière plastique  
 Wit  Kunststof

- ▶ Näherungsschalter für die An-/Aus-Schaltung der LED-Strips und anderer Produkte
- ▶ Max. 75 W (magnetische Trafos)
- ▶ Max. 60 W (elektronische Last)
- ▶ Max. 250 W (Glühlampen)

- ▶ Interrupteur de proximité Marche/Arrêt des rubans LED et autres produits
- ▶ Max. 75 W (transformateurs magnétiques)
- ▶ Max. 60 W (charge électronique)
- ▶ Max. 250 W (ampoules à incandescence)



- ▶ Naderingsschakelaar voor het in-/uitschakelen van de LED-Strips en andere producten
- ▶ Max. 75 W (magnetische trafo's)
- ▶ Max. 60 W (elektronische last)
- ▶ Max. 250 W (gloeilampen)



**PIR-Sensor 230V**

max. 60 W  
230 V  
⌀19 ⌀17,5 ↔85 ↗36 mm  
EAN 4000870 704516  
**704.51** 



 120°  
0,5-5m  
5s-60s  
for Strip  
 193, 195

 Weiß  Kunststoff  
 Blanc  Matière plastique  
 Wit  Kunststof



**IR-Sensor**

max. 60 W  
DC 12 V  
⌀18 ↔50 ↗36 mm  
EAN 4000870 707265  
**707.26** 



for Strip  
 193, 195

 Weiß  Kunststoff  
 Blanc  Matière plastique  
 Wit  Kunststof



**On/Off Switch**

max. 60 W  
DC 12 V  
⌀15 ↔60 ↗26 mm  
EAN 4000870 707272  
**707.27** 



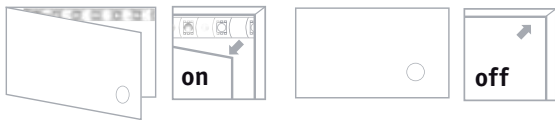

- 👉 Weiß 📦 Kunststoff
- 👉 Blanc 📦 Matière plastique
- 👉 Wit 📦 Kunststof

- |  |  |  |
|--|--|--|
| <ul style="list-style-type: none"> <li>▶ Magnetschalter zur praktischen Steuerung von YourLED Strips an Türen, Fenstern oder Möbelstücken.</li> <li>▶ Geeignet zur Steuerung von einfarbigen Strips 3000K, 4000K, 6000K</li> <li>▶ Einfache Montage mit Klebepads</li> </ul> | <ul style="list-style-type: none"> <li>▶ Commutateur magnétique pour la commande pratique de Strips YourLED sur les portes, fenêtres ou meubles.</li> <li>▶ Convient au contrôle de rubans monochromes 3000 K, 4000 K, 6000 K</li> <li>▶ Montage aisé grâce à des pastilles autocollantes</li> </ul> | <ul style="list-style-type: none"> <li>▶ Magneetschakelaar voor praktische besturing van YourLED Strips aan deuren, ramen of meubelstukken.</li> <li>▶ Geschikt voor de besturing van eenkleurige strips 3000K, 4000K, 6000K</li> <li>▶ Eenvoudige montage met hecht pads</li> </ul> |
|--|--|--|



**Magnetic Switch**

max. 60 W  
 DC 12 V  
 ⚡13,5 ↔40 ⚡20 mm  
 EAN 4000870 709108  
**709.10** 🚚 **new**



- 👉 Silber 📦 Kunststoff
- 👉 Argent 📦 Matière plastique
- 👉 Zilver 📦 Kunststof

- |   |   |   |
|---|---|---|
| <ul style="list-style-type: none"> <li>▶ Bequem schalten und dimmen durch Antippen</li> <li>▶ Touchschalter zur modernen Steuerung von YourLED Strips</li> <li>▶ Geeignet zur Steuerung von einfarbigen Strips 3000K, 4000K, 6000K</li> <li>▶ Einfache Montage mit Klebepads</li> </ul> | <ul style="list-style-type: none"> <li>▶ Commutation et variation d'intensité confortables par simple effleurement</li> <li>▶ Commutateur tactile pour un contrôle moderne des Strips YourLED</li> <li>▶ Convient au contrôle de rubans monochromes 3000 K, 4000 K, 6000 K</li> <li>▶ Montage aisé grâce à des pastilles autocollantes</li> </ul> | <ul style="list-style-type: none"> <li>▶ Comfortabel schakelen en dimmen door aantikken</li> <li>▶ Touchschakelaar voor moderne besturing van YourLED Strips</li> <li>▶ Geschikt voor de besturing van eenkleurige strips 3000K, 4000K, 6000K</li> <li>▶ Eenvoudige montage met hecht pads</li> </ul> |
|---|---|---|

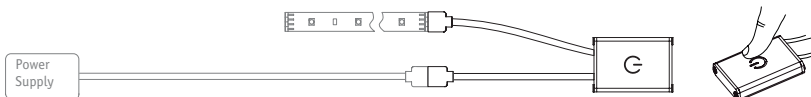

**Touch Switch**

max. 60 W  
 DC 12 V  
 ⚡8,5 ↔43 ⚡30 mm  
 EAN 4000870 709139  
**709.13** 🚚 **new**



- 👉 Weiß 📦 Kunststoff
- 👉 Blanc 📦 Matière plastique
- 👉 Wit 📦 Kunststof

- |  |  |  |
|--|--|--|
| <ul style="list-style-type: none"> <li>▶ Mini-Schalter und Dimmer zur praktischen Steuerung von YourLED Strips</li> <li>▶ Geeignet zur Steuerung von einfarbigen Strips 3000K, 4000K, 6000K</li> </ul> | <ul style="list-style-type: none"> <li>▶ Mini-commutateur pour le contrôle pratique des Strips YourLED</li> <li>▶ Convient au contrôle de rubans monochromes 3000 K, 4000 K, 6000 K</li> </ul> | <ul style="list-style-type: none"> <li>▶ Minischakelaar voor praktische besturing van YourLED Strips</li> <li>▶ Geschikt voor de besturing van eenkleurige strips 3000K, 4000K, 6000K</li> </ul> |
|--|--|--|

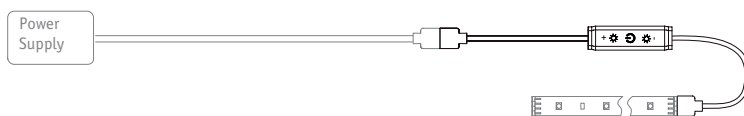

**Cord Switch**

max. 60 W  
 DC 12 V  
 ⚡5,5 ↔52 ⚡12 mm  
 EAN 4000870 709146  
**709.14** 🚚 **new**





- 👉 Silber 📦 Kunststoff
- 👉 Argent 📦 Matière plastique
- 👉 Zilver 📦 Kunststof

- ▶ Dämmerungsschalter zur tageslichtabhängigen Steuerung von YourLED Strips - schafft Komfort und Sicherheit
- ▶ Geeignet zur Steuerung von einfarbigen Strips 3000K, 4000K, 6000K
- ▶ Sensibilität fest definiert (<20Lux = Licht an)
- ▶ Einfache Montage mit Klebepads

- ▶ Interrupteur crépusculaire pour la commande de YourLED asservie à la lumière du jour - Crée confort et de sécurité
- ▶ Convient au contrôle de rubans monochromes 3000 K, 4000 K, 6000 K
- ▶ Sensibilité fixe (< 20Lux = lumière allumée)
- ▶ Montage aisé grâce à des pastilles autocollantes

- ▶ Schemerschakelaar voor daglichtafhankelijke besturing van YourLED Strips, zorgt voor comfort en veiligheid
- ▶ Geschikt voor de besturing van eenkleurige strips 3000K, 4000K, 6000K
- ▶ Gevoeligheid vast ingesteld (<20 lux = licht aan)
- ▶ Eenvoudige montage met hecht pads



**Twilight Sensor**

max. 60 W  
 DC 12 V  
 ⚡8,5 ⇄43 ⚡30 mm  
 EAN 4000870 709153  
**709.15** 📦 **new**

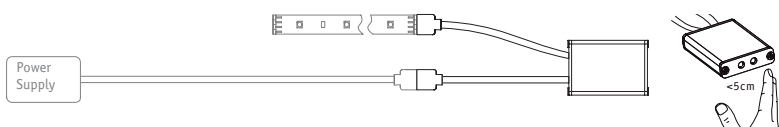

- 👉 Silber 📦 Kunststoff
- 👉 Argent 📦 Matière plastique
- 👉 Zilver 📦 Kunststof

- ▶ Näherungsschalter schaltet ab 3 cm Ein oder Aus
- ▶ Touchschalter zur berührungslosen Steuerung von YourLED Strips
- ▶ Geeignet zur Steuerung von einfarbigen Strips 3000K, 4000K, 6000K
- ▶ Einfache Montage mit Klebepads

- ▶ Détecteur de proximité commutation M/A à partir de 3 cm
- ▶ Commutateur tactile pour la commande sans contact des Strips YourLED
- ▶ Convient au contrôle de rubans monochromes 3000 K, 4000 K, 6000 K
- ▶ Montage aisé grâce à des pastilles autocollantes

- ▶ Naderingsschakelaar schakelt vanaf 3cm Aan of Uit
- ▶ Touchschakelaar voor contactloze besturing van YourLED Strips
- ▶ Geschikt voor de besturing van eenkleurige strips 3000K, 4000K, 6000K
- ▶ Eenvoudige montage met hecht pads



**PIR-Sensor**

max. 60 W  
 DC 12 V  
 ⚡8,5 ⇄43 ⚡30 mm  
 EAN 4000870 709160  
**709.16** 📦 **new**





- 👉 Schwarz 📦 Kunststoff
- 👉 Noir 📦 Matière plastique
- 👉 Zwart 📦 Kunststof

- ▶ RGB-Sound-Sensor - erfasst Töne und Musik und setzt diese in einen dynamischen Lichteindruck bei YourLED RGB Strips um - das Klasse Party Licht
- ▶ Geeignet zur Steuerung von farbigen RGB Strips

- ▶ Capteur de sons RGB - capte les tonalités et la musique puis les convertit en une impression lumineuse dynamique sur vos Strips RGB YourLED. - L'éclairage Party classe
- ▶ Convient au contrôle de rubans RGB de couleur

- ▶ RGB-soundsensor – detecteert tonen en muziek en zet deze bij YourLED RGB Strips om in een dynamische lichtindruk - de partylamp bij uitstek
- ▶ Geschikt voor de besturing van kleurige RGB strips

for  
RGB Color  
☐ = 192, 194



**RGB-Sound-Sensor**

max. 60 W  
CR 2025 × 1  
DC 12 V  
⇄22 ⇄60 ⇄35 mm  
EAN 4000870 709177  
**709.17** 📦 **new**

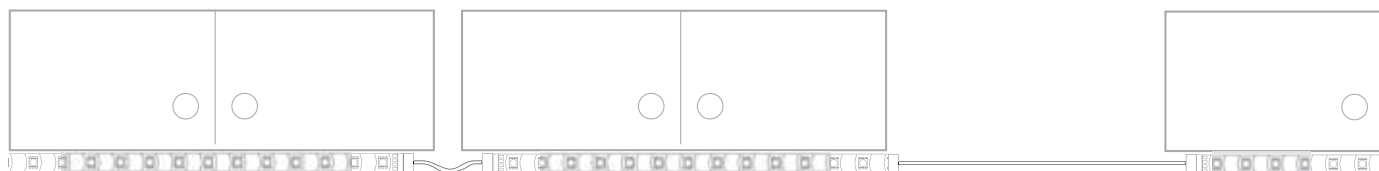

**Flex-Connector 10cm**

⇄5 mm ⇄13 mm ⇄0,1 m  
EAN 4000870 702154  
**702.15** 📦

- 👉 Weiß 📦 Kunststoff
- 👉 Blanc 📦 Matière plastique
- 👉 Wit 📦 Kunststof



**Flex-Connector 1m**

⇄13 mm ⇄5 mm ⇄1 m  
EAN 4000870 702048  
**702.04** 📦

- 👉 Weiß 📦 Kunststoff
- 👉 Blanc 📦 Matière plastique
- 👉 Wit 📦 Kunststof



**Flex-Connector 5m**

max. 60 W  
⇄13 mm ⇄5 mm ⇄5 m  
EAN 4000870 702512  
**702.51** 📦

- 👉 Weiß 📦 Kunststoff
- 👉 Blanc 📦 Matière plastique
- 👉 Wit 📦 Kunststof

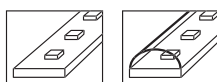

- 👉 Weiß 📦 Kunststoff
- 👉 Blanc 📦 Matière plastique
- 👉 Wit 📦 Kunststof

- ▶ Geeignet für beschichtete und unbeschichtete YourLED Strips
- ▶ Passend für alle Paulmann Profile

- ▶ Adapté aux Strips YourLED gainés et non gainés
- ▶ Pour tous les profilés Paulmann

- ▶ Geschikt voor gecoate en niet-gecoate YourLED Strips
- ▶ Geschikt voor alle Paulmann profielen



**Universal YourLED Connector**

max. 60 W  
⇄7 ⇄100 ⇄16 mm  
EAN 4000870 709184  
**709.18** 📦 **new**





**Junction-Box**

max. 60 W  
 ⌀12 ⇄30 ↗45 mm  
 EAN 4000870 702031  
**702.03**

- 🌀 Weiß 📦 Kunststoff
- 🌀 Blanc 📦 Matière plastique
- 🌀 Wit 📦 Kunststof



**X-Connector**

max. 60 W  
 ⌀7 ⇄33 ↗33 mm  
 EAN 4000870 702826  
**702.82**

- 🌀 Weiß 📦 Kunststoff
- 🌀 Blanc 📦 Matière plastique
- 🌀 Wit 📦 Kunststof



**Edge-Connector Pack**

max. 60 W  
 ⌀12 ⇄17 ↗13 mm  
 EAN 4000870 703342  
**703.34**

- 🌀 Weiß/Schwarz
- 🌀 Blanc/Noir
- 🌀 Wit/Zwart



**Edge-Connector 90° Pack**

max. 60 W  
 ⌀5 ⇄23 ↗23 mm  
 EAN 4000870 705995  
**705.99**

- 🌀 Weiß/Schwarz
- 🌀 Blanc/Noir
- 🌀 Wit/Zwart



**ECO Clip-to-Clip Connector Pack**

max. 60 W  
 ⌀6 ⇄13,5 ↗14 mm  
 EAN 4000870 704899  
**704.89**

- 🌀 Weiß 📦 Kunststoff
- 🌀 Blanc 📦 Matière plastique
- 🌀 Wit 📦 Kunststof



**ECO Clip-to-YourLED Connector Pack**

max. 60 W  
 ⌀6 ⇄13 ↗18 mm  
 EAN 4000870 704905  
**704.90**

- 🌀 Weiß 📦 Kunststoff
- 🌀 Blanc 📦 Matière plastique
- 🌀 Wit 📦 Kunststof



**ECO Clip Connector Pack**

⌀6 mm ⇄13,5 mm ⇄0,5 m  
 EAN 4000870 704882  
**704.88**

- 🌀 Weiß 📦 Kunststoff
- 🌀 Blanc 📦 Matière plastique
- 🌀 Wit 📦 Kunststof





- 🔗 Weiß 📦 Kunststoff
- 🔗 Blanc 📦 Matière plastique
- 🔗 Wit 📦 Kunststof

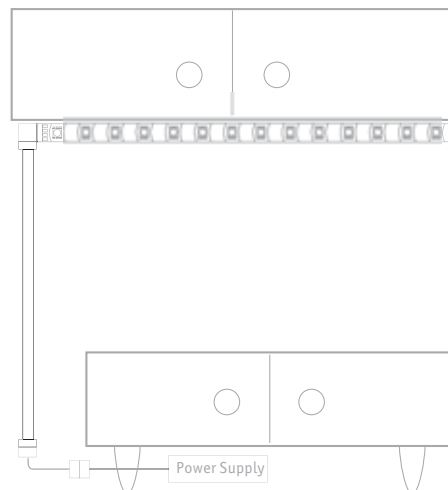

**Flat Connector**

max. 60W  
 ↕10 mm ↔19 mm ↗16,5 mm ↔3 m  
 EAN 4000870 704868  
**704.86** 📦



**Flat Connector**

max. 60W  
 ↕10 mm ↔19 mm ↗16,5 mm ↔5 m  
 EAN 4000870 704875  
**704.87** 📦



- 🔗 Transparent 📦 Kunststoff
- 🔗 Transparent 📦 Matière plastique
- 🔗 Transparant 📦 Kunststof

- ▶ Zur Erzielung eines IP-Schutzes an beschichteten YourLED Streifen
- ▶ Schützt die Verbindungsstellen zwischen Streifen und Systemsteckern
- ▶ 4:1 Schrumpfverhältnis
- ▶ Permet d'obtenir une protection IP pour les rubans YourLED avec revêtement
- ▶ Protège les jointures entre les coins du ruban et du système
- ▶ Rapport de rétraction 4:1
- ▶ Voor een IP-beveiliging aan gecoate YourLED strips
- ▶ Beveiligt de verbindingspunten tussen strips en systeemhoeken
- ▶ Rapporto di restringimento 4:1



**Water Protection**

ø14 ↔150 mm  
 EAN 4000870 702475  
**702.47** 📦



- 👉 Weiß 📦 Kunststoff
- 👉 Blanc 📦 Matière plastique
- 👉 Wit 📦 Kunststof

not incl.  
Remote Control  
☑= 400



**YourLED Switch/Dimm Controller**

max. 60 W  
DC 12 V  
⌀19 ⇄39 ↗80 mm  
EAN 4000870 500385  
**500.38** 📦

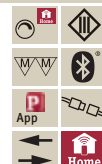

**YourLED RGB Controller**

max. 60 W  
DC 12 V  
⌀19 ⇄39 ↗80 mm  
EAN 4000870 500392  
**500.39** 📦

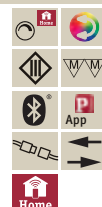

- 👉 Weiß/Grau 📦 Kunststoff
- 👉 Blanc/Gris 📦 Matière plastique
- 👉 Wit/Grijs 📦 Kunststof

not incl.  
Remote Control  
☑= 402



**YourLED Switch/Dimm Controller**

max. 60 W  
DC 12 V  
⌀28 ⇄38 ↗95 mm  
EAN 4000870 500484  
**500.48** 📦

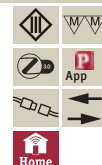

**YourLED RGB Controller**

max. 60 W  
DC 12 V  
⌀28 ⇄38 ↗95 mm  
EAN 4000870 500491  
**500.49** 📦

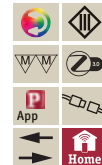







## Flaex LED RGB



not incl.  
Remote Control

□ = 400

 **Bluetooth®**

-  Weiß  Kunststoff
-  Blanc  Matière plastique
-  Wit  Kunststof



### Flaex LED Strip Set 5m RGB

incl. 1x18 W  
536 lm  
∠ 120°  
230/12 V, incl. ⚡ 24 VA  
∅ 3 mm ∅ 10,5 mm ⇄ 5 m  
EAN 4000870 500057  
**500.05**

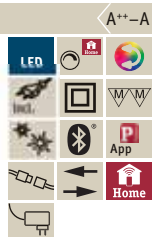



## Reflex LED



not incl.  
Remote Control

□ = 402



- ☞ Weiß ☐ Kunststoff
- ☞ Blanc ☐ Matière plastique
- ☞ Wit ☐ Kunststof

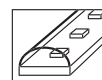

### Reflex LED Strip Set 3m Tunable White

A++-A

incl. 1x20 W  
1.650-1.740 lm, 3.000 - 6.500 K  
∠ 120°  
230/24 V, incl. ⚡ 20 VA  
⏏ 3 mm ⏏ 12,5 mm ⏏ 3 m  
EAN 4000870 500804  
**500.80**

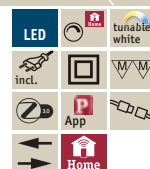

not incl.  
Remote Control

□ = 402



- ☞ Weiß ☐ Kunststoff
- ☞ Blanc ☐ Matière plastique
- ☞ Wit ☐ Kunststof

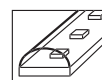

### Reflex LED Strip Set 3m RGBW

A++-A

incl. 1x20 W  
750-780 lm, 3.000 K  
∠ 120°  
230/24 V, incl. ⚡ 20 VA  
⏏ 3 mm ⏏ 12,5 mm ⏏ 3 m  
EAN 4000870 500811  
**500.81**

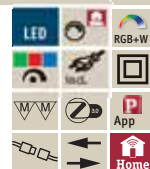

## FlexLED 3D

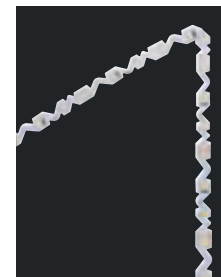

- ▶ Die FlexLED 3D Strips lassen sich in jede Richtung verlegen, als Kurve, Ecke oder Kante – alles ohne Zubehör
- ▶ Die Strips können auf einen minimalen Winkel von 60° gebogen werden
- ▶ Die Komplettssets inkl. Steuerung laden ein sofort loszulegen
- ▶ Les Strips FlexLED 3D se posent dans n'importe quelle direction, en courbe, dans les coins ou sur les arêtes – et tout cela sans accessoires.
- ▶ Les Strips peuvent se plier à un angle minimal de 60°.
- ▶ Les kits complets avec commande invitent à démarrer immédiatement.
- ▶ De FlexLED 3D strips zijn in elke richting te leggen, als bocht, hoek of rand – alles zonder toebehoren
- ▶ De strips kunnen gebogen worden tot een minimale hoek van 60°
- ▶ De complete sets incl. besturing laden en direct van start gaan



- 👉 Weiß 🏠 Kunststoff
- 👉 Blanc 🏠 Matière plastique
- 👉 Wit 🏠 Kunststof



### FlexLED 3D Set Warm white 1,5m

incl. 1x5 W  
480 lm, 3.000 K  
230/12 V, incl. ⚡ 6 VA  
⤴ 1,5 mm ⤵ 9 mm ⤴ 1,5 m  
EAN 4000870 789612  
**789.61** 📦 **new**



### FlexLED 3D Set Warm white 3m

incl. 1x8,0 W  
960 lm, 3.000 K  
230/12 V, incl. ⚡ 12 VA  
⤴ 1,5 mm ⤵ 9 mm ⤴ 3 m  
EAN 4000870 789629  
**789.62** 📦 **new**



### FlexLED 3D Set Warm white 5m

incl. 1x10,5 W  
1.600 lm, 3.000 K  
230/12 V, incl. ⚡ 12 VA  
⤴ 1,5 mm ⤵ 9 mm ⤴ 5 m  
EAN 4000870 789636  
**789.63** 📦 **new**



## FlexLED RGB 3D

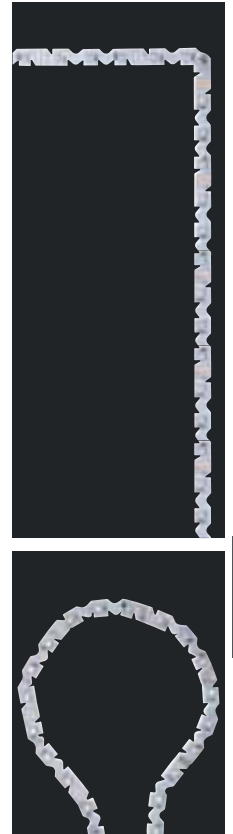

- ▶ Die FlexLED 3D Strips lassen sich in jede Richtung verlegen, als Kurve, Ecke oder Kante – alles ohne Zubehör
- ▶ Die Strips können auf einen minimalen Winkel von 90° gebogen werden
- ▶ Die Komplettssets inkl. Steuerung laden ein sofort loszulegen
- ▶ Les Strips FlexLED 3D se posent dans n'importe quelle direction, en courbe, dans les coins ou sur les arêtes – et tout cela sans accessoires.
- ▶ Les Strips peuvent se plier à un angle minimal de 90°.
- ▶ Les kits complets avec commande invitent à démarrer immédiatement.
- ▶ De FlexLED 3D strips zijn in elke richting te leggen, als bocht, hoek of rand – alles zonder toebehoren
- ▶ De strips kunnen gebogen worden tot een minimale hoek van 90°.
- ▶ De complete sets incl. besturing laden en direct van start gaan



- 👉 Weiß 📦 Kunststoff
- 👉 Blanc 📦 Matière plastique
- 👉 Wit 📦 Kunststof



### FlexLED 3D Set RGB 1,5m

incl. 1x11 W  
230/12V, incl. ⚡ 12 VA  
⌀2 mm ⌀13 mm ⇄1,5 m  
EAN 4000870 789643  
**789.64** 📦 **new**



### FlexLED 3D Set RGB 3m

incl. 1x19 W  
230/12V, incl. ⚡ 24 VA  
⌀2 mm ⌀13 mm ⇄3 m  
EAN 4000870 789650  
**789.65** 📦 **new**



### FlexLED 3D Set RGB 5m

incl. 1x26 W  
230/12V, incl. ⚡ 36 VA  
⌀2 mm ⌀13 mm ⇄5 m  
EAN 4000870 789667  
**789.66** 📦 **new**



## Digital LED Strip Motion

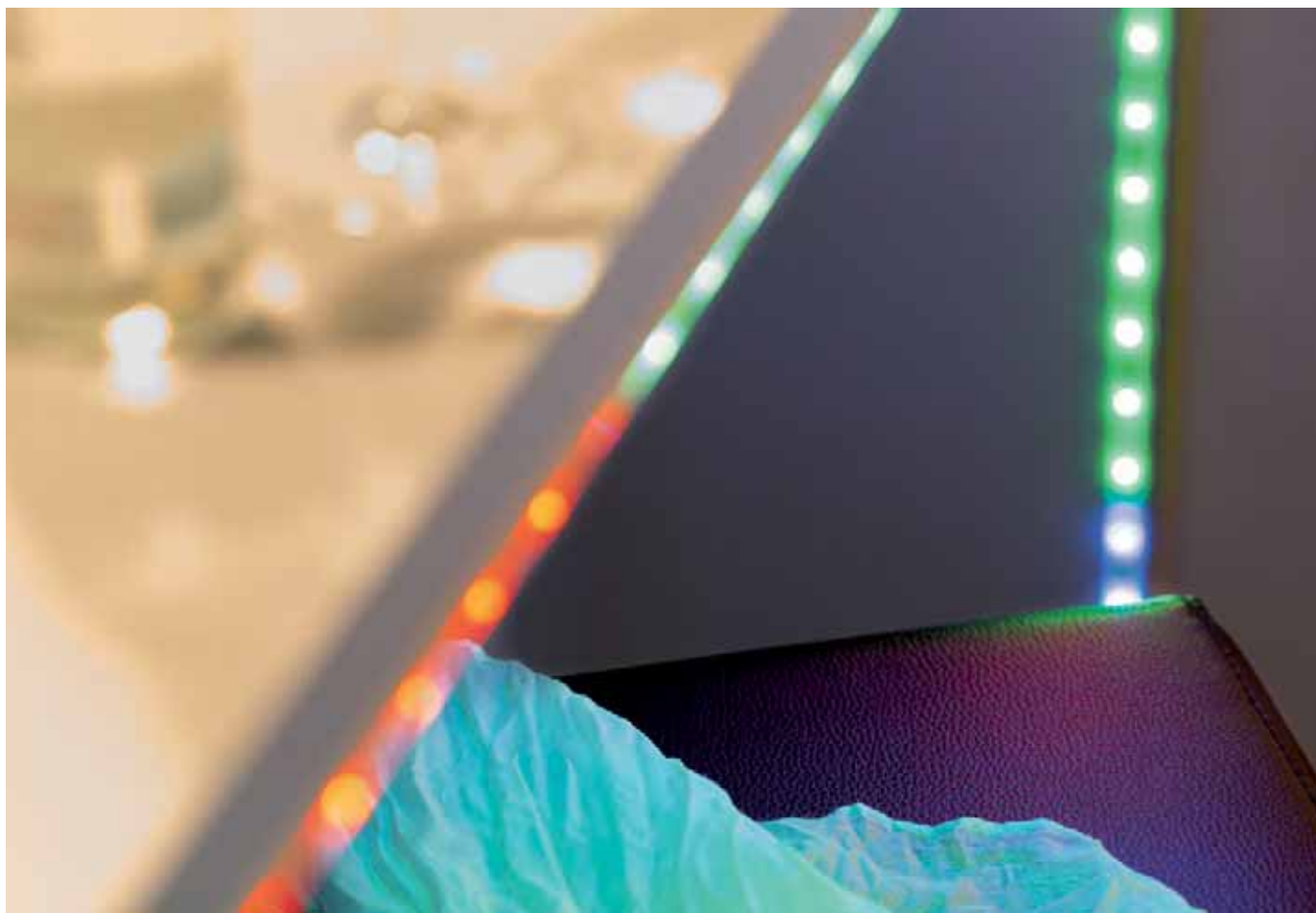

- ▶ Elektronisch kürzbares LED-Strip Set mit 164 Funktionen für vielfältige Lichteffekte
- ▶ Die digitale Steuerung erlaubt Farbmischungen in dynamischen Rhythmen
- ▶ Dimm- und schaltbar per Fernbedienung.
- ▶ Vom Strip-Ende her können Segmentweise je 3 LED abgeschaltet werden. Dadurch kann der Strip in passender Länge an unterschiedlichen Plätzen eingesetzt werden.
- ▶ Kit de ruban LED raccourcissable électroniquement et équipé de 164 fonctions pour créer de nombreux effets de lumière
- ▶ La commande numérique permet de mélanger les couleurs dans des rythmes dynamiques
- ▶ Variation de l'intensité et commutation avec télécommande.
- ▶ Vous pouvez désactiver les LED à partir de l'extrémité du ruban par groupe de 3. Le ruban peut ainsi être placé à différents endroits avec la longueur requise.
- ▶ Elektronisch inkortbare LED-Strip set met 164 functies voor veelzijdige lichteffecten
- ▶ Met de digitale besturing zijn kleurmengingen in dynamische ritmes mogelijk
- ▶ Dim- en schakelbaar per afstandsbediening.
- ▶ Vanuit het Strip-uiteinde kunnen segmentgewijs telkens 3 LED's worden uitgeschakeld. Daardoor kan de Strip in passende lengte op verschillende plaatsen worden ingezet.

- 👉 Weiß 📦 Kunststoff
- 👉 Blanc 📦 Matière plastique
- 👉 Wit 📦 Kunststof



**Digital LED Strip Motion Color Set 3m**

A++-A

incl. 1x10 W  
165 lm  
230/12 V, incl. ⚡ 12 VA  
⤴3 mm ⤵10,5 mm ⤵3 m  
EAN 4000870 704813  
**704.81** 📦



**Digital LED Strip Motion Color Set 5m**

A++-A

incl. 1x16,5 W  
275 lm  
230/12 V, incl. ⚡ 18 VA  
⤴3 mm ⤵10,5 mm ⤵5 m  
EAN 4000870 704806  
**704.80** 📦



- 👉 Weiß 📦 Kunststoff
- 👉 Blanc 📦 Matière plastique
- 👉 Wit 📦 Kunststof



**Digital LED Strip Motion Color + White Set 1,5m**

A++-A

incl. 1x5,5 W  
535 lm, 3.000 K  
CR 2025 x 1  
230/12 V, incl. ⚡ 12 VA  
⤴3 mm ⤵1.525 mm ⤵10 mm  
EAN 4000870 709092  
**709.09** 📦 **new**



**Digital LED Strip Motion Color+White Set 3m**

A++-A

incl. 1x8 W  
1.070 lm, 3.000 K  
230/12 V, incl. ⚡ 24 VA  
⤴3 mm ⤵3.050 mm ⤵10 mm ⤵3 m  
EAN 4000870 706961  
**706.96** 📦



**Digital LED Strip Motion Color+White Set 4,8m**

A++-A

incl. 1x10,5 W  
1.710 lm, 3.000 K  
230/12 V, incl. ⚡ 24 VA  
⤴3 mm ⤵4.880 mm ⤵10 mm  
⤵4,8 m  
EAN 4000870 706978  
**706.97** 📦



## YourLED IP 44 Strip



- ▶ YourLED LED-Strips für diespritzwassergeschützte Montage in Bad und Feuchtraum (IP44). Die beschichteten Strips werden mittels Schrumpfschlauch an den Verbindungsstellen optimal abgedichtet.
- ▶ Zuverlässiger Spritzwasserschutz durch hohen Schrumpfungsgrad und Schmelzklebe-Dichtung
- ▶ Optimale Dichtungsergebnisse bei Verwendung eines handelsüblichen Heißluftföhns
- ▶ Kombinierbar mit YourLED Verbindern und Zubehör
- ▶ Steckverbinder für einfache Montage
- ▶ Selbstklebend, flexibel und kürzbar wie bekannte YourLED LED-Strips
- ▶ Rubans LED YourLED pour un montage protégé dans la salle de bain ou les pièces humides (IP44). Les rubans gainés sont isolés de manière optimale au niveau des points de connexion par la gaine thermorétractable.
- ▶ La protection contre les projections d'eau est renforcée par un fort degré de rétraction et l'adhésif thermo plastique
- ▶ Rétraction optimale obtenue par l'utilisation d'un sèche-cheveux standard (sur position chaude)
- ▶ Combinable avec les connecteurs et accessoires YourLED
- ▶ Montage facile avec des connexions rapides
- ▶ Autocollants, flexibles et raccourçissables comme les autres rubans YourLED
- ▶ YourLED LED-strips voor spatwaterdichte montage in badkamer en vochtige ruimtes (IP44). De gecoate strips worden met krimpslang aan de verbindingpunten optimaal afgedicht.
- ▶ Betrouwbare spatwaterbescherming door hoge krimpgraad en smeltafdichting
- ▶ Optimale afdichting bij gebruik van een gebruikelijke heteluchtföhn
- ▶ Combineerbaar met YourLED verbinders en toebehoren
- ▶ Eenvoudige montage door steekverbindingen
- ▶ Zelfklevend, flexibel en inkortbaar zoals de bekende YourLED LED-strips

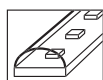

⌘ Schwarz 

--	--	--

 Kunststoff  
 ⌘ Noir 

--	--	--

 Matière plastique  
 ⌘ Zwart 

--	--	--

 Kunststof

Accessories  
 ☐ = 196-205



**Strip RGB IP44 97cm**

incl. 1x7 W  
 184 lm  
 ✗ 120°  
 DC 12 V  
 ⚙ 3 mm ⇄ 975 mm ↗ 10,5 mm ⇄ 1 m  
 EAN 4000870 703113  
**703.11**

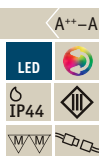

**Strip Pack RGB IP44 3x97cm**

incl. 3x7 W  
 3x550 lm  
 ✗ 120°  
 DC 12 V  
 ⚙ 3 mm ⇄ 2.925 mm ↗ 10,5 mm  
 ⇄ 1 m  
 EAN 4000870 703120  
**703.12**

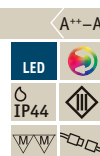

**Basic Set RGB 3m IP44**

incl. 1x17,8 W  
 3x550 lm  
 ✗ 120°  
 230/12 V, incl. ⚡ 24 VA  
 ⚙ 3 mm ↗ 10,5 mm ⇄ 3-5 m  
 EAN 4000870 705124  
**705.12**

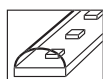

⌘ Weiß 

--	--	--

 Kunststoff  
 ⌘ Blanc 

--	--	--

 Matière plastique  
 ⌘ Wit 

--	--	--

 Kunststof

Accessories  
 ☐ = 196-205



**Strip Warm white IP44 97cm**

incl. 1x3 W  
 265 lm, 3.000 K  
 ✗ 120°  
 DC 12 V  
 ⚙ 3 mm ⇄ 975 mm ↗ 10,5 mm ⇄ 1 m  
 EAN 4000870 703090  
**703.09**



**Strip Pack Warm white IP44 3x97cm**

incl. 3x3 W  
 3x265 lm, 3.000 K  
 ✗ 120°  
 DC 12 V  
 ⚙ 3 mm ⇄ 2.925 mm ↗ 10,5 mm ⇄ 1 m  
 EAN 4000870 704073  
**704.07**



**Basic Set Warm white 3m IP44**

incl. 1x7,5 W  
 800 lm, 3.000 K  
 ✗ 120°  
 230/12 V, incl. ⚡ 18 VA  
 ⚙ 3 mm ↗ 10,5 mm ⇄ 3-7,5 m  
 EAN 4000870 705100  
**705.10**



**Strip Daylight IP44 97cm**

incl. 1x3 W  
 270 lm, 6.000 K  
 ✗ 120°  
 DC 12 V  
 ⚙ 3 mm ⇄ 975 mm ↗ 10,5 mm ⇄ 1 m  
 EAN 4000870 703106  
**703.10**



**Strip Pack Daylight IP44 3x97cm**

incl. 3x3 W  
 3x270 lm, 6.000 K  
 ✗ 120°  
 DC 12 V  
 ⚙ 3 mm ⇄ 2.925 mm ↗ 10,5 mm ⇄ 1 m  
 EAN 4000870 704080  
**704.08**



**Basic Set Daylight 3m IP44**

incl. 1x7,5 W  
 810 lm, 6.000 K  
 ✗ 120°  
 230/12 V, incl. ⚡ 18 VA  
 ⚙ 3 mm ↗ 10,5 mm ⇄ 3-7,5 m  
 EAN 4000870 705117  
**705.11**

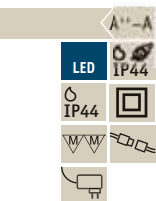

## WaterLED



- ▶ Allseitig ummantelte LED-Strips für die dekorative Außenbeleuchtung im Garten, am Hauseingang, unterm Dachsturz, in Feuchträumen und an vielen anderen Stellen (IP67 - tauchwassergeschützt).
- ▶ Plug'n'play: steckerfertiges Komplettsset für die einfache Verlegung
- ▶ Inkl. Trafo (IP64 - staubdicht und spritzwassergeschützt).
- ▶ Inkl. 1m Zuleitung - 5m Verlängerungsleitung als Zubehör erhältlich (IP65 - strahlwassergeschützt)
- ▶ LED-Strips sind alle 10cm kürzbar - Endkappe und Silikon Versiegelung inkl.
- ▶ Zur freien Verlegung oder Befestigung mit Kunststoffbügeln (inkl.)
- ▶ Nicht für den Einsatz im Umfeld aggressiver Chemikalien (Chlorwasser u.ä.)
- ▶ Rubans LED totalement gainées pour de l'éclairage extérieur décoratif dans votre jardin, devant l'entrée de la maison, sous la pente du toit, dans des pièces humides et dans pleins d'autres endroits (IP67 - étanche à l'immersion temporaire).
- ▶ Plug & Play : kit complet prêt à poser
- ▶ Transfo. inclus (IP64 - étanche à la poussière et aux éclaboussures).
- ▶ Alimentation de 1m inclus - Extension de 5m disponible comme accessoire (IP65 - Protection contre les jets d'eau directs)
- ▶ Les rubans LED sont raccourçissables tous les 10cm - caches de finition et embouts silicone inclus
- ▶ Pour une installation avec ou sans supports de fixation en plastique (inclus)
- ▶ Ne convient pas une utilisation dans un environnement comportant des produits chimiques (chlore...)
- ▶ Aan alle zijde bedekte LED-strips voor decoratieve buitenverlichting in de tuin, bij de huisingang, onder afdakkingen, in vochtige ruimtes en op vele andere plekken (IP67 - dompelwaterbeschermd).
- ▶ Plug'n'play: steckerklare complete set voor eenvoudige montage
- ▶ Incl. trafo (IP64 - stofdicht en spatwaterdicht).
- ▶ Incl. 1m toevoerleiding - 5m verlengleiding als toebehoren verkrijgbaar (IP65 - spuitwaterdicht)
- ▶ LED-strips kunnen elke 10cm worden ingekort - eindkap en silicone verzegeling incl.
- ▶ Voor vrije montage of bevestiging met kunststofbeugels (incl.)
- ▶ Niet voor gebruik in de buurt van agressieve chemicaliën (chlorwater etc.)





Wei Kunststoff  
Blanc Matire plastique  
Wit Kunststof

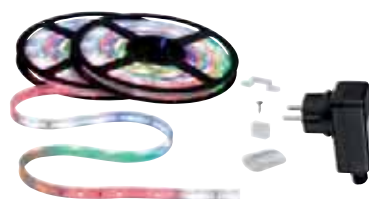

**WaterLED Multicolor 3m**

incl. 1x7 W  
220 lm  
230/12 V, incl. 7,2 VA  
4,5 mm 10 mm 3 m  
EAN 4000870 704165  
**704.16**

A+-A

LED IP44

IP67

W/W

W/W

**WaterLED Multicolor 5m**

incl. 1x10,5 W  
350 lm  
230/12 V, incl. 12 VA  
4,5 mm 10 mm 5 m  
EAN 4000870 704158  
**704.15**

A+-A

LED IP44

IP67

W/W

W/W

**WaterLED Multicolor 7,5m**

incl. 1x14 W  
550 lm  
230/12 V, incl. 18 VA  
4,5 mm 10 mm 7,5 m  
EAN 4000870 704141  
**704.14**

A+-A

LED IP44

IP67

W/W

W/W



Wei Kunststoff  
Blanc Matire plastique  
Wit Kunststof



**WaterLED Neutral white 3m**

incl. 1x7 W  
420 lm, 4.000 K  
230/12 V, incl. 7,2 VA  
4,5 mm 10 mm 3 m  
EAN 4000870 704196  
**704.19**

A+-A

LED IP44

IP67

W/W

W/W

**WaterLED Neutral white 5m**

incl. 1x10,5 W  
700 lm, 4.000 K  
230/12 V, incl. 12 VA  
4,5 mm 10 mm 5 m  
EAN 4000870 704189  
**704.18**

A+-A

LED IP44

IP67

W/W

W/W

**WaterLED Neutral white 7,5m**

incl. 1x14 W  
1.000 lm, 4.000 K  
230/12 V, incl. 18 VA  
4,5 mm 10 mm 7,5 m  
EAN 4000870 704172  
**704.17**

A+-A

LED IP44

IP67

W/W

W/W



**WaterLED Flex-Connector 5m**

DC 12 V  
5 m  
EAN 4000870 704134  
**704.13**

IP65

W/W

Schwarz Gummi  
Noir Caoutchouc  
Zwart Rubber

## WaterLED Digital Motion Color



- ▶ Elektronisch kürzbares LED-Strip Set mit 164 Funktionen für vielfältige Lichteffekte
- ▶ Die digitale Steuerung erlaubt Farbmischungen in dynamischen Rhythmen
- ▶ Dimm- und schaltbar per Fernbedienung.
- ▶ Vom Strip-Ende her können Segmentweise je 3 LED abgeschaltet werden. Dadurch kann der Strip in passender Länge an unterschiedlichen Plätzen eingesetzt werden.
- ▶ Kit de ruban LED raccourcissable électroniquement et équipé de 164 fonctions pour créer de nombreux effets de lumière
- ▶ La commande numérique permet de mélanger les couleurs dans des rythmes dynamiques
- ▶ Variation de l'intensité et commutation avec télécommande.
- ▶ Vous pouvez désactiver les LED à partir de l'extrémité du ruban par groupe de 3. Le ruban peut ainsi être placé à différents endroits avec la longueur requise.
- ▶ Elektronisch inkortbare LED-Strip set met 164 functies voor veelzijdige lichteffecten
- ▶ Met de digitale besturing zijn kleurmengingen in dynamische ritmes mogelijk
- ▶ Dim- en schakelbaar per afstandsbediening.
- ▶ Vanuit het Strip-uiteinde kunnen segmentgewijs telkens 3 LED's worden uitgeschakeld. Daardoor kan de Strip in passende lengte op verschillende plaatsen worden ingezet.



- 👉 Weiß 📦 Kunststoff
- 👉 Blanc 📦 Matière plastique
- 👉 Wit 📦 Kunststof



**WaterLED Digital Motion Color Set 3m** A++-A

incl. 1x6,4 W  
160 lm  
230/12 V, incl. ⚡ 24 VA  
⌀5 mm ⇄3.050 mm ↗12 mm ⇄3 m  
EAN 4000870 706985  
**706.98** 📦

- LED
- incl. 📶
- IP44
- IP67
- 🔌
- 📺

- 📶
- 📺
- 🔌
- 📺
- 📺
- 📺



**WaterLED Digital Motion Color Set 4,88m** A++-A

incl. 1x9,8 W  
256 lm  
230/12 V, incl. ⚡ 24 VA  
⌀5 mm ⇄4.880 mm ↗12 mm  
⇄4,8 m  
EAN 4000870 706992  
**706.99** 📦

- LED
- incl. 📶
- IP44
- IP67
- 🔌
- 📺

- 📶
- 📺
- 🔌
- 📺
- 📺
- 📺

SimpLED



- 🔗 Weiß 📦 Metall/Kunststoff
- 🔗 Blanc 📦 Métal/Matière plastique
- 🔗 Wit 📦 Metaal/Kunststof

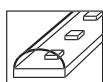

**SimpLED Warm white 5m**

incl. 1x17 W  
960 lm, 3.000 K  
230/12 V, incl. ⚡ 18 VA  
⌀3 mm ⌀8 mm ⇄5 m  
EAN 4000870 789728  
**789.72** 📦

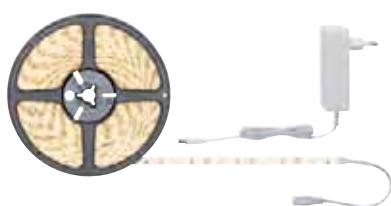

**SimpLED Warm white 7,5m**

incl. 1x20 W  
1.440 lm, 3.000 K  
230/12 V, incl. ⚡ 24 VA  
⌀3 mm ⌀8 mm ⇄7,5 m  
EAN 4000870 789735  
**789.73** 📦

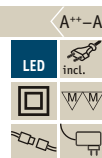

**SimpLED Warm white 10m**

incl. 1x22 W  
1.920 lm, 3.000 K  
230/12 V, incl. ⚡ 36 VA  
⌀3 mm ⌀8 mm ⇄10 m  
EAN 4000870 789742  
**789.74** 📦

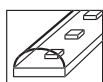

- 🔗 Weiß 📦 Metall/Kunststoff
- 🔗 Blanc 📦 Métal/Matière plastique
- 🔗 Wit 📦 Metaal/Kunststof



**SimpLED Daylight 5m**

incl. 1x17 W  
935 lm, 6.500 K  
230/12 V, incl. ⚡ 18 VA  
⌀3 mm ⌀8 mm ⇄5 m  
EAN 4000870 789759  
**789.75** 📦

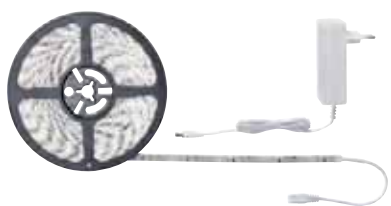

**SimpLED Daylight 7,5m**

incl. 1x20 W  
1.402 lm, 6.500 K  
230/12 V, incl. ⚡ 24 VA  
⌀3 mm ⌀8 mm ⇄7,5 m  
EAN 4000870 789766  
**789.76** 📦



**SimpLED Daylight 10m**

incl. 1x22 W  
1.870 lm, 6.500 K  
230/12 V, incl. ⚡ 36 VA  
⌀3 mm ⌀8 mm ⇄10 m  
EAN 4000870 789773  
**789.77** 📦



## SimpLED RGB

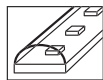

- ☞ Weiß ☒ Metall/Kunststoff
- ☞ Blanc ☒ Métal/Matière plastique
- ☞ Wit ☒ Metaal/Kunststof



### SimpLED RGB 5m

incl. 1x20 W  
505 lm  
230/12 V, incl. ⚡ 24 VA  
⌀3 mm ⌀10 mm ⇄5 m  
EAN 4000870 789780  
**789.78** 📦



### SimpLED RGB 7,5m

incl. 1x26 W  
760 lm  
230/12 V, incl. ⚡ 36 VA  
⌀3 mm ⌀10 mm ⇄7,5 m  
EAN 4000870 789797  
**789.79** 📦



### SimpLED RGB 10m

incl. 1x28 W  
1.010 lm  
230/12 V, incl. ⚡ 36 VA  
⌀3 mm ⌀10 mm ⇄10 m  
EAN 4000870 789803  
**789.80** 📦



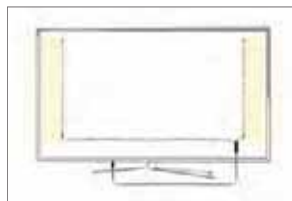

- ↳ Schwarz Metall/Kunststoff
- ↳ Noir Métal/Matière plastique
- ↳ Zwart Metaal/Kunststof



USB-Strip



**USB-Strip Warm white 2x50cm**

incl. 2x1 W  
 2x60 lm, 3.000 K  
 ⌀3 mm ⇔500 mm ↗10 mm ⇔0,5 m  
 EAN 4000870 707050  
**707.05**

A++-A

LED

USB

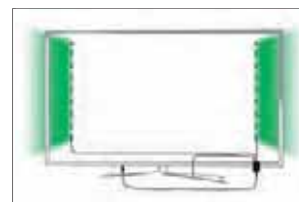
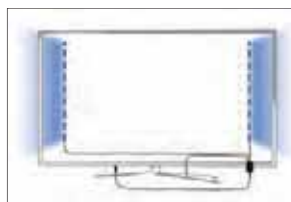

- ↳ Schwarz Metall/Kunststoff
- ↳ Noir Métal/Matière plastique
- ↳ Zwart Metaal/Kunststof



USB-Strip



**USB-Strip RGB 2x50cm**

incl. 2x1,25 W  
 2x40 lm  
 ✕ 120°  
 CR 2025 x 1  
 ⌀3 mm ⇔500 mm ↗10 mm ⇔0,5 m  
 EAN 4000870 707067  
**707.06**

A++-A

LED

incl.

USB

incl. Battery



⚪ Weiß  Metall/Kunststoff  
 ⚪ Blanc  Métal/Matière plastique  
 ⚪ Wit  Metaal/Kunststof

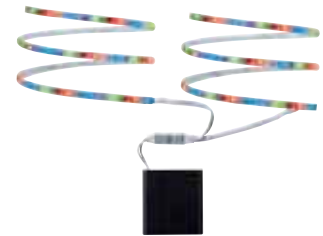
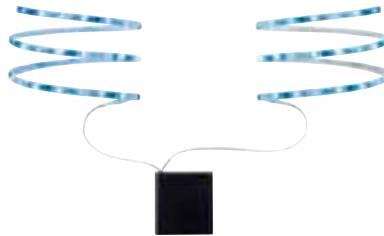
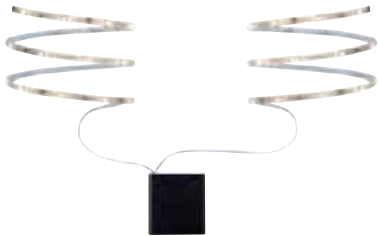

**Mobil Strip (4x1,5V AA excl.)**

incl. 2x0,9 W  
 2x95 lm, 2.700 K  
 AA/1,5 V (Mignon) x 4  
 ⌀3 mm ⇄800 mm ↗5 mm ⇄0,8 m  
 EAN 4000870 707012  
**707.01**



**Mobil Strip Blue (4x1,5V AA excl.)**

incl. 2x0,6 W  
 2x8 lm  
 AA/1,5 V (Mignon) x 4  
 ⌀3 mm ⇄800 mm ↗5 mm ⇄0,8 m  
 EAN 4000870 707029  
**707.02**



**Mobil Strip RGB (4x1,5V AA excl.)**

incl. 2x1,2 W  
 2x28 lm  
 AA/1,5 V (Mignon) x 4  
 ⌀3 mm ⇄800 mm ↗5 mm ⇄0,8 m  
 EAN 4000870 707005  
**707.00**

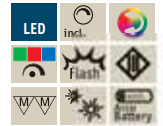

⚪ Weiß  Metall/Kunststoff  
 ⚪ Blanc  Métal/Matière plastique  
 ⚪ Wit  Metaal/Kunststof



**USB-Strip Daylight 30cm**

incl. 1x1,5 W, 60 lm, 6.000 K  
 ⌀2,5 mm ⇄300 mm ↗5 mm ⇄0,3 m  
 EAN 4000870 704554  
**704.55**

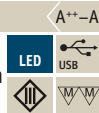

**USB-Strip Blue 30cm**

incl. 1x1,5 W  
 ⌀3 mm ⇄300 mm ↗5 mm ⇄0,3 m  
 EAN 4000870 704561  
**704.56**

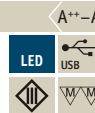

**USB-Strip Green/White 30cm**

incl. 1x1,5 W  
 ⌀2,5 mm ⇄300 mm ↗5 mm ⇄0,3 m  
 EAN 4000870 707043  
**707.04**

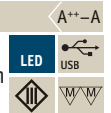

**USB-Strip Red/White 30cm**

incl. 1x1,5 W  
 ⌀3 mm ⇄300 mm ↗5 mm ⇄0,3 m  
 EAN 4000870 704578  
**704.57**

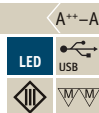

**USB-Strip Blue/White 30cm**

incl. 1x1,5 W  
 ⌀2,5 mm ⇄300 mm ↗5 mm ⇄0,3 m  
 EAN 4000870 707036  
**707.03**

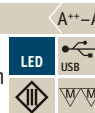



**USB-Light Stick 22cm**

A++-A

incl. 1x0,5 W  
45 lm, 6.500 K  
DC 5 V  
⌀9 ⇄220 ⌀18 mm  
EAN 4000870 708880

**708.88** new

- Blau Kunststoff
- Bleu Matière plastique
- Blauw Kunststof



**USB-Light Stick 22cm**

A++-A

incl. 1x0,5 W  
45 lm, 6.500 K  
DC 5 V  
⌀9 ⇄220 ⌀18 mm  
EAN 4000870 708897

**708.89** new

- Orange Kunststoff
- Orange Matière plastique
- Oranje Kunststof



**USB-Light Stick 22cm**

A++-A

incl. 1x0,5 W  
45 lm, 6.500 K  
DC 5 V  
⌀9 ⇄220 ⌀18 mm  
EAN 4000870 708873

**708.87** new

- Pink Kunststoff
- Rose Matière plastique
- Roze Kunststof



**USB-Light Stick 22cm**

A++-A

incl. 1x0,5 W  
45 lm, 6.500 K  
DC 5 V  
⌀9 ⇄220 ⌀18 mm  
EAN 4000870 708866

**708.86** new

- Schwarz Kunststoff
- Noir Matière plastique
- Zwart Kunststof



**USB-Light Stick 22cm**

A++-A

incl. 1x0,5 W  
45 lm, 6.500 K  
DC 5 V  
⌀9 ⇄220 ⌀18 mm  
EAN 4000870 708859

**708.85** new

- Weiß Kunststoff
- Blanc Matière plastique
- Wit Kunststof



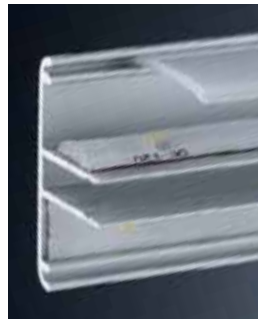

for LED Strip

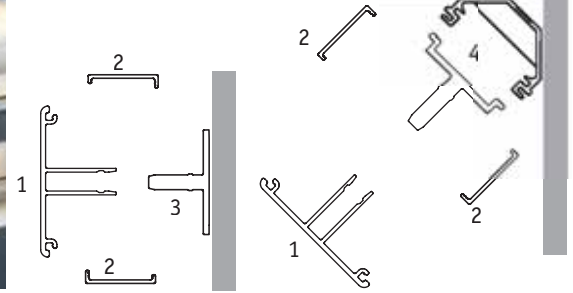

702.73 + 702.68



703.30 + 702.68



702.74 + 702.68



703.53 + 702.68

- ▶ Hochwertiges Doppel-T-Profil aus Aluminium mit eloxierter Oberfläche - für zweiseitige Lichteffekte
- ▶ Zur vielseitigen Beleuchtung mit dem YourLED Strip-System
- ▶ Dekoratives Licht zur Inszenierung von Wohnräumen
- ▶ Optionaler Diffusor für gleichmäßige Lichtverteilung
- ▶ Für Wand-, Decken- oder Eckmontage
- ▶ Vielseitiges Zubehör für die Verlegung und Profilaabschlüsse
- ▶ Inkl. Kabelführung
- ▶ Positiver Kühleffekt für LED-Strips

- ▶ Profilé double T haut de gamme en aluminium anodisé – avec effet lumineux sur deux côtés
- ▶ Pour un éclairage varié avec le système de ruban YourLED
- ▶ Éclairage décoratif pour une mise en valeur des pièces de séjour
- ▶ Diffuseur en option pour une répartition uniforme de la lumière
- ▶ Pour un montage sur mur, plafond ou en coin
- ▶ Nombreux embouts de profilé et accessoires pour la pose
- ▶ Guide câble inclus
- ▶ Effet de refroidissement positif pour les rubans LED

- ▶ Hoogwaardig dubbel-T-profiel van aluminium met geëloxeerd oppervlak – voor dubbelzijdige lichteffecten
- ▶ Voor veelzijdige verlichting met het YourLED stripsysteem
- ▶ Decoratieve verlichting voor het insceneren van woonruimtes
- ▶ Optionele diffusor voor gelijkmatige lichtverdeling
- ▶ Voor wand-, plafond- of hoekmontage
- ▶ Veelzijdig toebehoren voor montage en profielafsluitingen
- ▶ Incl. kabelgeleiding
- ▶ Positief koeleffect voor LED-strips



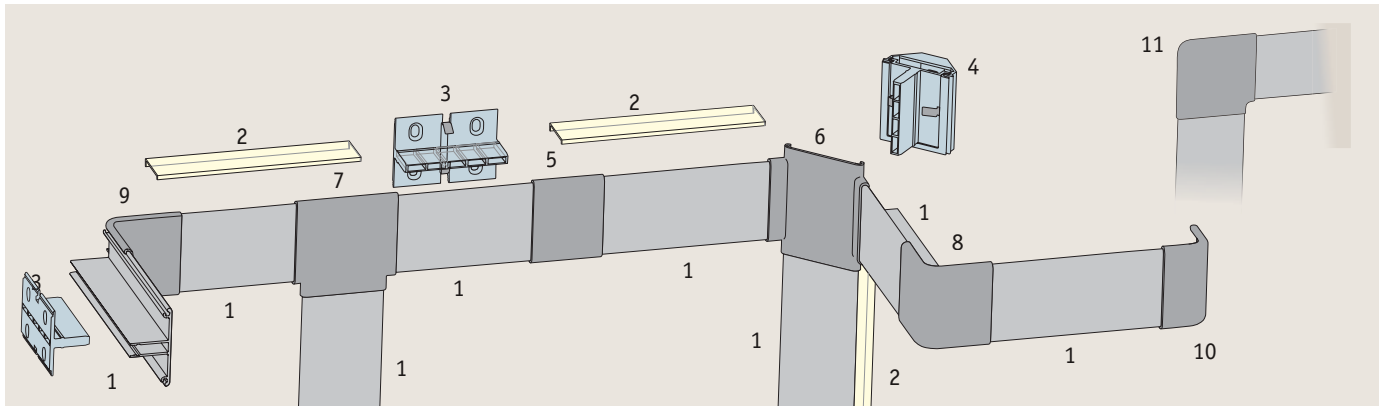

**Duo Profil 1m**

↕40 mm ↗20 mm ↔1 m  
EAN 4000870 702680

**702.68**

- 🌀 Alu 🗍 Alu
- 🌀 Alu 🗍 Alu
- 🌀 Alu 🗍 Alu



**Duo Profil 2m**

↕40 mm ↗20 mm ↔2 m  
EAN 4000870 702673

**702.67**

- 🌀 Alu 🗍 Alu
- 🌀 Alu 🗍 Alu
- 🌀 Alu 🗍 Alu



**Duo Profil Diffusor**

↕4 mm ↗20 mm ↔2 m  
EAN 4000870 702697

**702.69**

- 🌀 Satin 🗍 Kunststoff
- 🌀 Satiné 🗍 Matière plastique
- 🌀 Satijn 🗍 Kunststof



**Duo Profil Fixture**

↕36 ↔50 ↗21 mm  
EAN 4000870 702698

**702.75**

- 🌀 Transparent 🗍 Kunststoff
- 🌀 Transparent
- 🗍 Matière plastique
- 🌀 Transparant 🗍 Kunststof



**Duo Profil Clix**

↕40 ↔36 ↗37 mm  
EAN 4000870 702215

**702.21**

- 🌀 Transparent 🗍 Kunststoff
- 🌀 Transparent
- 🗍 Matière plastique
- 🌀 Transparant 🗍 Kunststof

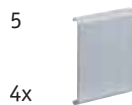

**Duo Profil Cover**

↕42 ↔35 ↗5 mm  
EAN 4000870 702703

**702.70**

- 🌀 Alu matt 🗍 Kunststoff
- 🌀 Alu mat 🗍 Matière plastique
- 🌀 Alu mat 🗍 Kunststof



**Duo Profil X-Cover**

↕55 ↔55 ↗10 mm  
EAN 4000870 703304

**703.30**

- 🌀 Alu matt 🗍 Kunststoff
- 🌀 Alu mat 🗍 Matière plastique
- 🌀 Alu mat 🗍 Kunststof



**Duo Profil T-Cover**

↕49 ↔50 ↗5 mm  
EAN 4000870 702710

**702.71**

- 🌀 Alu matt 🗍 Kunststoff
- 🌀 Alu mat 🗍 Matière plastique
- 🌀 Alu mat 🗍 Kunststof

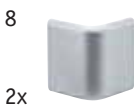

**Duo Profil Outside Corner**

↕42 ↔35 ↗35 mm  
EAN 4000870 702734

**702.73**

- 🌀 Alu matt 🗍 Kunststoff
- 🌀 Alu mat 🗍 Matière plastique
- 🌀 Alu mat 🗍 Kunststof

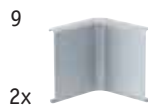

**Duo Profil Inside Corner**

↕42 ↔39 ↗39 mm  
EAN 4000870 702727

**702.72**

- 🌀 Alu matt 🗍 Kunststoff
- 🌀 Alu mat 🗍 Matière plastique
- 🌀 Alu mat 🗍 Kunststof



**Duo Profil End Cap**

↕42 ↔22 ↗24 mm  
EAN 4000870 702741

**702.74**

- 🌀 Alu matt 🗍 Kunststoff
- 🌀 Alu mat 🗍 Matière plastique
- 🌀 Alu mat 🗍 Kunststof



**Duo Profil 90° Corner**

↕20 ↔60 ↗60 mm  
EAN 4000870 704530

**704.53**

- 🌀 Alu matt 🗍 Kunststoff
- 🌀 Alu mat 🗍 Matière plastique
- 🌀 Alu mat 🗍 Kunststof

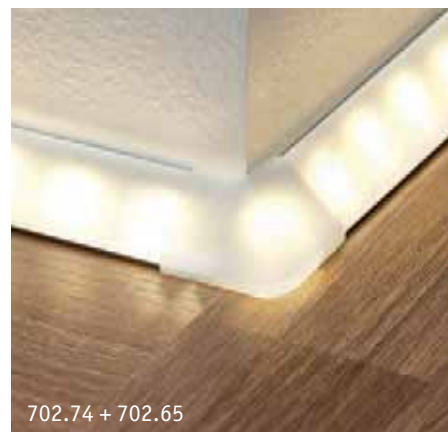

- ▶ Hochwertiges Winkel-Profil aus Aluminium mit eloxierter Oberfläche inklusive Diffusor
- ▶ Zur vielseitigen Beleuchtung mit dem YourLED Strip-System
- ▶ Dekoratives Licht zur Inszenierung von Fußleisten oder Abschlusskanten
- ▶ Zusatzbeleuchtung von Nutzflächen oder Unterschränken
- ▶ Orientierungs- und Leitlicht an Schattenzonen oder Gefahrstellen
- ▶ Vielseitiges Zubehör für die Verlegung und Profilabschlüsse
- ▶ Durch Einsatz sparsamer LED-Strips auch als Dauerlicht verwendbar
- ▶ Positiver Kühleffekt für LED-Strips

- ▶ Profilé angulaire haut de gamme en aluminium anodisé avec diffuseur
- ▶ Pour un éclairage varié avec le système de ruban YourLED
- ▶ Éclairage décoratif pour une mise en valeur des plinthes ou des cornières
- ▶ Éclairage additionnel de surfaces utiles ou de sous-meubles
- ▶ Lumière d'orientation ou de guidage dans les zones sombres ou les endroits dangereux
- ▶ Nombreux embouts de profilé et accessoires pour la pose
- ▶ Utilisable en lumière continue grâce à l'emploi de rubans DEL économiques
- ▶ Effet de refroidissement positif pour les rubans LED

- ▶ Hoogwaardig hoekprofiel van aluminium met geëloxeerd oppervlak inclusief diffusor
- ▶ Voor veelzijdige verlichting met het YourLED stripsysteem
- ▶ Decoratieve verlichting voor de inscenering van voetlijsten of afsluitranden
- ▶ Extra verlichting van gebruiksvlakken of onderkasten
- ▶ Oriëntatie- en geleidelicht bij schaduwzones of gevarenpunten
- ▶ Veelzijdig toebehoren voor montage en profielafsluitingen
- ▶ Kan door gebruik van energiebesparende LED-strips ook als continulicht worden gebruikt
- ▶ Positief koeleffect voor LED-strips



for LED Strip

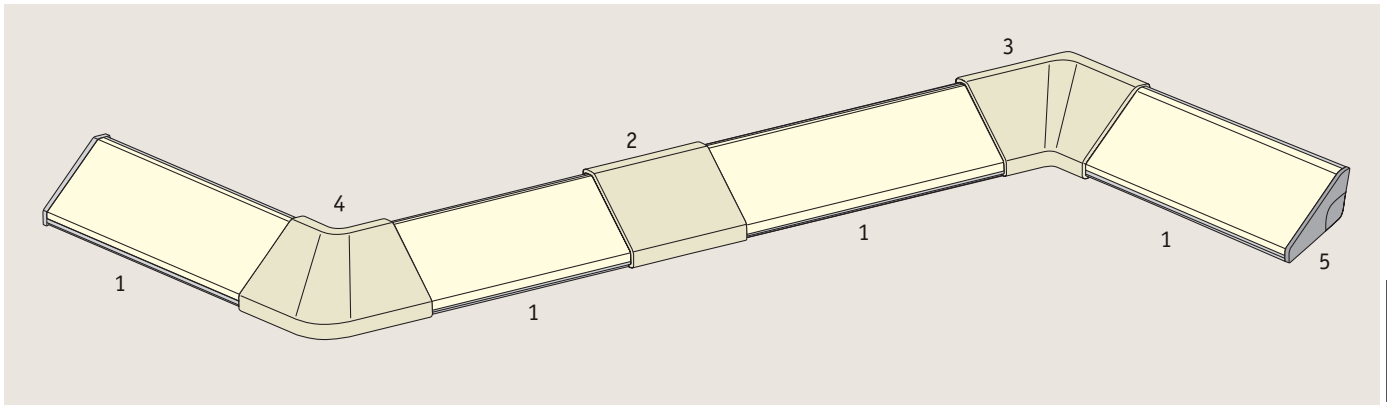
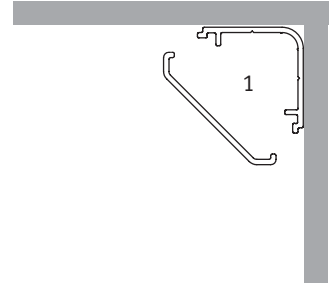

2013

**Delta Profil incl. Diffusor 1m**

∅20 mm ∅20 mm ⇄1 m  
EAN 4000870 702628

**702.62**

- 🔗 Alu/Satin 📦 Alu/Kunststoff
- 🔗 Alu/Satiné 📦 Alu/Matière plastique
- 🔗 Alu/Satijn 📦 Alu/Kunststof

**Delta Profil incl. Diffusor 2m**

∅20 mm ∅20 mm ⇄2 m  
EAN 4000870 702611

**702.61**

- 🔗 Alu/Satin 📦 Alu/Kunststoff
- 🔗 Alu/Satiné 📦 Alu/Matière plastique
- 🔗 Alu/Satijn 📦 Alu/Kunststof

**Delta Profil Cover**

∅29 ⇄35 ∅5 mm  
EAN 4000870 702635

**702.63**

- 🔗 Satin 📦 Kunststoff
- 🔗 Satiné 📦 Matière plastique
- 🔗 Satijn 📦 Kunststof

**Delta Profil Inside Corner**

∅21 ⇄35 ∅35 mm  
EAN 4000870 702642

**702.64**

- 🔗 Satin 📦 Kunststoff
- 🔗 Satiné 📦 Matière plastique
- 🔗 Satijn 📦 Kunststof

**Delta Profil Outside Corner**

∅21 ⇄35 ∅35 mm  
EAN 4000870 702659

**702.65**

- 🔗 Satin 📦 Kunststoff
- 🔗 Satiné 📦 Matière plastique
- 🔗 Satijn 📦 Kunststof

**Delta Profil End Cap**

∅20 ⇄8 ∅20 mm  
EAN 4000870 702666

**702.66**

- 🔗 Alu matt 📦 Kunststoff
- 🔗 Alu mat 📦 Matière plastique
- 🔗 Alu mat 📦 Kunststof



- 🔗 Alu/Satin 🏠 Alu/Kunststoff
- 🔗 Alu/Satiné 🏠 Alu/Matière plastique
- 🔗 Alu/Satijn 🏠 Alu/Kunststof



for LED Strip



- ▶ Einbauprofil zur Beleuchtung mit LED-Strips schafft reizvolle Beleuchtungseffekte. Auch zum Einsatz als Orientierungs- oder Leitlicht geeignet.
- ▶ Hochwertiges Aluminium Profil mit trittfester Abdeckung (130 kg begehbar)
- ▶ Gleichmäßige Lichtverteilung
- ▶ Zum Einfräsen in Materialien ab 12 mm Stärke oder zum dauerhaften Verkleben in Laminat, Fliesen und Teppichboden.
- ▶ Inkl. Endkappen
- ▶ Nicht für schwimmend verlegtes Laminat geeignet

- ▶ Profilé encastrable avec de l'éclairage par rubans LED réalisant de ravissants effets lumineux. Idéal aussi pour de l'éclairage de balisage ou d'accentuation.
- ▶ Profil en aluminium de haute qualité avec un couvercle incassable (supporte une charge de 130 kg)
- ▶ Répartition uniforme de la lumière
- ▶ Pour entourer des matières d'au moins 12mm d'épaisseur ou pour coller durablement dans du parquet, du carrelage ou de la moquette.
- ▶ Embouts inclus
- ▶ Ne convient pas pour une utilisation dans du parquet flottant

- ▶ Inbouwprofiel ter verlichting met LED-strips voor inspirerende verlichtingseffecten. Ook voor gebruik als oriëntatie- of geleidingslicht.
- ▶ Hoogwaardig aluminium profiel met antislip afdekking (130 kg draagvermogen)
- ▶ Gelijkmatische lichtverdeling
- ▶ Voor het frezen in materiaal vanaf 12 mm dikte of voor permanente hechting in laminaat, tegel en tapijt.
- ▶ Incl. eindkappen
- ▶ Niet geschikt voor flexibel gelegd laminaat



#### Floor Profil 1m

⌀9 ↔1.010 ↗27 mm  
EAN 4000870 704103  
**704.10**



#### Floor Profil 2m

⌀9 ↔2.010 ↗27 mm  
EAN 4000870 704097  
**704.09**





- 🔗 Grau 📦 Kunststoff
- 🔗 Gris 📦 Matière plastique
- 🔗 Grijs 📦 Kunststof

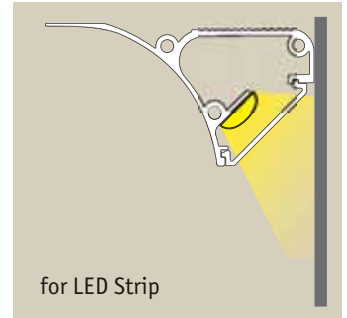

- |   |  |  |
|---|--|--|
| <ul style="list-style-type: none"> <li>▶ Dekoratives Deckenprofil zur indirekten Anstrahlung der Wand mit LED-Strips</li> <li>▶ Gleichmäßige Lichtverteilung</li> <li>▶ Lieferung inkl. Abschlusskappen für gerade Wandanschnitte</li> <li>▶ Innen- und Außenecken als Zubehör erhältlich</li> <li>▶ Außenecken können auch als Anfangs- und Endpunkt auf gerader Strecke verwendet werden.</li> <li>▶ Befestigung mittels handelsüblichen Bauklebern</li> <li>▶ Zur Verlegung von LED-Strips und Kabelverbindern.</li> </ul> | <ul style="list-style-type: none"> <li>▶ Profil décoratif pour le plafond pour un éclairage indirect des murs avec rubans LED.</li> <li>▶ Répartition uniforme de la lumière</li> <li>▶ Livré avec des caches</li> <li>▶ Caches pour coins intérieurs et extérieurs disponibles en tant qu'accessoires</li> <li>▶ Les coins extérieurs peuvent servir de point de départ ou d'arrivée.</li> <li>▶ Fixation avec un mastic colle standard</li> <li>▶ Pour une pose avec rubans LED et câbles de connexion.</li> </ul> | <ul style="list-style-type: none"> <li>▶ Decoratief plafondprofiel voor indirecte verlichting van de wand met LED-strip.</li> <li>▶ Gelijkmatische lichtverdeling</li> <li>▶ Levering incl. afsluitkappen voor rechte wandmontage</li> <li>▶ Binnen- en buitenhoeken als toebehoren verkrijgbaar</li> <li>▶ Buitenhoeken kunnen ook als begin- en eindpunt op rechte delen worden gebruikt.</li> <li>▶ Bevestiging met gebruikelijke bouwlijm</li> <li>▶ Voor het leggen van LED-strips en kabelverbinders.</li> </ul> |
|---|--|--|



#### Corner Profil 1m

⌈31,5 mm ⌋49 mm ⇔1 m  
 EAN 4000870 704400  
**704.40** 📦



#### Corner Profil 2m

⌈31,5 mm ⌋49 mm ⇔2 m  
 EAN 4000870 704394  
**704.39** 📦



#### Corner Profil Inside Edge

⌈31,5 ⇔59 ⌋59 mm  
 EAN 4000870 704424  
**704.42** 📦

- 🔗 Grau 📦 Kunststoff
- 🔗 Gris 📦 Matière plastique
- 🔗 Grijs 📦 Kunststof

#### Corner Profil Outside Edge

⌈31,5 ⇔49 ⌋49 mm  
 EAN 4000870 704417  
**704.41** 📦

- 🔗 Grau 📦 Kunststoff
- 🔗 Gris 📦 Matière plastique
- 🔗 Grijs 📦 Kunststof



- ☞ Alu/Satin ☒ Alu/Kunststoff
- ☞ Alu/Satiné ☒ Alu/Matière plastique
- ☞ Alu/Satijn ☒ Alu/Kunststof

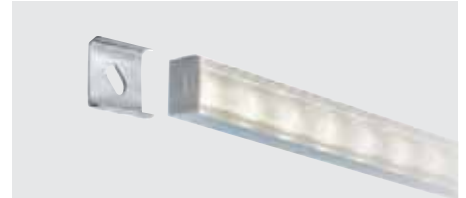
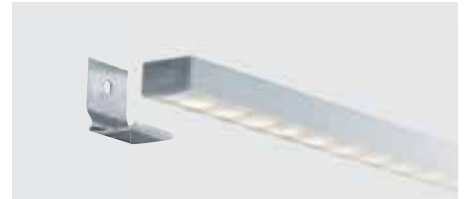

for LED Strip



**Square Profil incl. Diffusor 1m**

⌀15 mm ⌀23 mm ⇄1 m  
 EAN 4000870 708095  
**708.09** ➡



**Square Profil incl. Diffusor 2m**

⌀15 mm ⌀23 mm ⇄2 m  
 EAN 4000870 708101  
**708.10** ➡



- ☞ Alu eloxiert/Satin ☒ Alu/Kunststoff
- ☞ Alu anodisé/Satiné ☒ Alu/Matière plastique
- ☞ Alu geëloxeerd/Satijn ☒ Alu/Kunststof

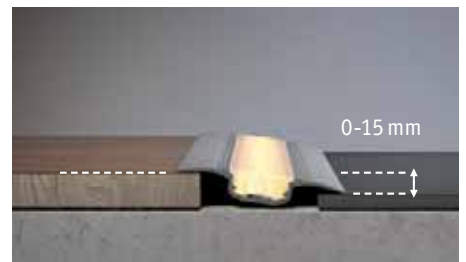

for LED Strip



**Step Profil incl. Diffusor 1m**

⌀60 mm ⇄1 m  
 EAN 4000870 708552  
**708.55** ➡

**Step Profil incl. Diffusor 2m**

⌀60 mm ⇄2 m  
 EAN 4000870 708569  
**708.56** ➡



- ☞ Alu eloxiert/Satin ☒ Alu/Kunststoff
- ☞ Alu anodisé/Satiné ☒ Alu/Matière plastique
- ☞ Alu geëloxeerd/Satijn ☒ Alu/Kunststof



for LED Strip

**Cup Profil incl. Diffusor 1m**

∅55,1 mm ∅14 mm ⇄1 m  
 EAN 4000870 708583  
**708.58** ➡

**Cup Profil incl. Diffusor 2m**

∅55,1 mm ∅14 mm ⇄2 m  
 EAN 4000870 708590  
**708.59** ➡



- ☞ Alu eloxiert/Satin ☒ Alu/Kunststoff
- ☞ Alu anodisé/Satiné ☒ Alu/Matière plastique
- ☞ Alu geëloxeerd/Satijn ☒ Alu/Kunststof



for LED Strip

**Deep Profil incl. Diffusor 1m**

∅27 mm ∅33 mm ⇄1 m  
 EAN 4000870 708606  
**708.60** ➡

**Deep Profil incl. Diffusor 2m**

∅27 mm ∅33 mm ⇄2 m  
 EAN 4000870 708613  
**708.61** ➡



- ↳ Alu eloxiert/Satin ▣ Alu/Kunststoff
- ↳ Alu anodisé/Satiné ▣ Alu/Matière plastique
- ↳ Alu geëloxeerd/Satijn ▣ Alu/Kunststof

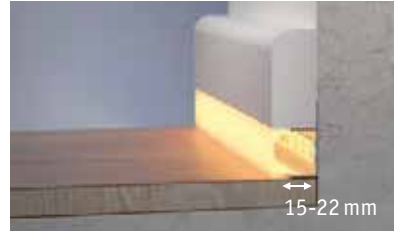
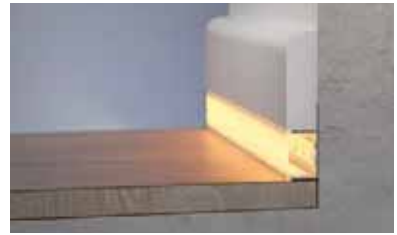

for LED Strip

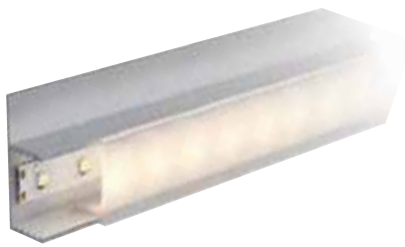

**Socle Profil incl. Diffusor 1m**

↕35 mm ↗12,5 mm ⇔1 m  
 EAN 4000870 708620  
**708.62** 📦

**Socle Profil incl. Diffusor 2m**

↕35 mm ↗12,5 mm ⇔2 m  
 EAN 4000870 708637  
**708.63** 📦





**Flying Strip Set** A++-A  
 incl. 1x26,5 W  
 300 lm  
 <math>\angle 120^\circ</math>  
 230/12 V, incl. <math>\text{---}</math> 48 VA  
 <math>\text{---}</math> 25 mm <math>\text{---}</math> 3 mm <math>\text{---}</math> 10,5 mm <math>\text{---}</math> 6 m  
 EAN 4000870 707173  
**707.17**

- <math>\text{---}</math> Schwarz/Alu <math>\text{---}</math> Kunststoff
- <math>\text{---}</math> Noir/Alu <math>\text{---}</math> Matière plastique
- <math>\text{---}</math> Zwart/Alu <math>\text{---}</math> Kunststof

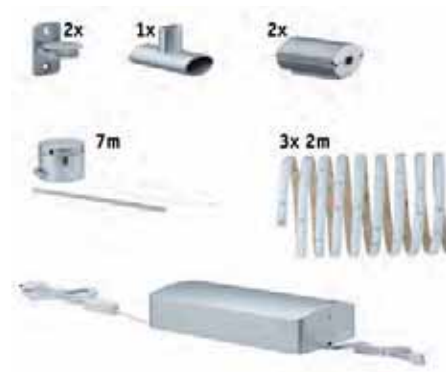

**Flying Strip Set** A++-A  
 incl. 1x14 W  
 400 lm, 3.000 K  
 <math>\angle 120^\circ</math>  
 230/12 V, incl. <math>\text{---}</math> 15 VA  
 <math>\text{---}</math> 25 mm <math>\text{---}</math> 3 mm <math>\text{---}</math> 10,5 mm <math>\text{---}</math> 6 m  
 EAN 4000870 707166  
**707.16**

- <math>\text{---}</math> Weiß/Alu <math>\text{---}</math> Kunststoff
- <math>\text{---}</math> Blanc/Alu <math>\text{---}</math> Matière plastique
- <math>\text{---}</math> Wit/Alu <math>\text{---}</math> Kunststof



**Flying Profil**  
 <math>\text{---}</math> 25 mm <math>\text{---}</math> 11 mm <math>\text{---}</math> 28 mm <math>\text{---}</math> 2 m  
 EAN 4000870 707159  
**707.15**  
 <math>\text{---}</math> Alu eloxiert/Satin <math>\text{---}</math> Alu/Kunststoff  
 <math>\text{---}</math> Alu anodisé/Satiné <math>\text{---}</math> Alu/Matière plastique  
 <math>\text{---}</math> Alu geëloxeerd/Satijn <math>\text{---}</math> Alu/Kunststof



**Wall-mounted Flying Profil**  
 <math>\text{---}</math> 25 <math>\text{---}</math> 33 <math>\text{---}</math> 30 <math>\text{---}</math> 35 mm  
 EAN 4000870 707197  
**707.19**  
 <math>\text{---}</math> Alu <math>\text{---}</math> Kunststoff  
 <math>\text{---}</math> Alu <math>\text{---}</math> Matière plastique  
 <math>\text{---}</math> Alu <math>\text{---}</math> Kunststof



**Flying Profil Diverter**  
 <math>\text{---}</math> 25 <math>\text{---}</math> 43 <math>\text{---}</math> 27 <math>\text{---}</math> 37 mm  
 EAN 4000870 707180  
**707.18**  
 <math>\text{---}</math> Alu <math>\text{---}</math> Alu  
 <math>\text{---}</math> Alu <math>\text{---}</math> Alu  
 <math>\text{---}</math> Alu <math>\text{---}</math> Alu



Silber Kunststoff  
 Argent Matière plastique  
 Zilver Kunststof

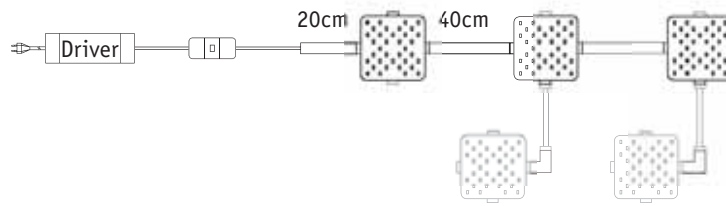

**MaxLED Softpad**

incl. 3x6,6W  
 3x572 lm, 2.700 K  
 230/24V, incl. 36 VA  
 ⌀3 ⇄220 ⌀65 mm  
 EAN 4000870 707098  
**707.09**

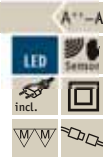

**MaxLED Softpad**

incl. 1x6,6W  
 572 lm, 2.700 K  
 24 V  
 ⌀3 ⇄220 ⌀65 mm  
 EAN 4000870 707128  
**707.12**

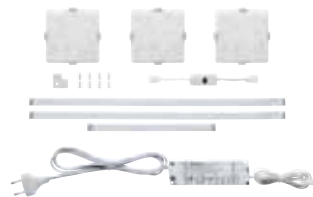

**MaxLED Softpad**

incl. 3x3,3W  
 3x288 lm, 2.700 K  
 230/24V, incl. 20 VA  
 ⌀3 ⇄85 ⌀85 mm  
 EAN 4000870 707104  
**707.10**



**MaxLED Softpad**

incl. 1x3,3W  
 288 lm, 2.700 K  
 24 V  
 ⌀3 ⇄85 ⌀85 mm  
 EAN 4000870 707135  
**707.13**

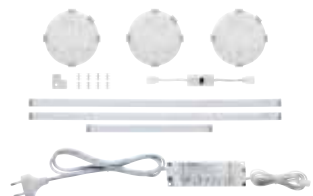

**MaxLED Softpad**

incl. 3x2,8W  
 3x240 lm, 2.700 K  
 230/24V, incl. 15 VA  
 ⌀3 ⌀85 mm  
 EAN 4000870 707111  
**707.11**

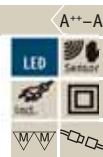

**MaxLED Softpad**

incl. 1x2,8W  
 240 lm, 2.700 K  
 24 V  
 ⌀3 ⌀85 mm  
 EAN 4000870 707142  
**707.14**



- 🔗 Satin/Weiß 🏠 Alu/Glas
- 🔗 Satiné/Blanc 🏠 Alu/Verre
- 🔗 Satijn/Wit 🏠 Alu/Glas

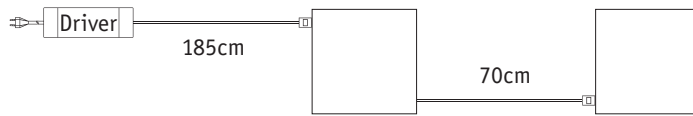

**Lumix**

A++-A

incl. 1x11,5 W  
 1.000 lm, 2.700 K  
 230/24 V, incl. ⚡ 36 VA  
 ⚡ 500 ↔ 500 ↗ 10 mm  
 EAN 4000870 708132  
**708.13** 📦



**Lumix**

A++-A

incl. 1x11,5 W  
 1.000 lm, 2.700 K  
 24 V  
 ⚡ 500 ↔ 500 ↗ 10 mm  
 EAN 4000870 708149  
**708.14** 📦



**Lumix**

A++-A

incl. 1x11,5 W  
 1.000 lm, 2.700 K  
 230/24 V, incl. ⚡ 36 VA  
 ⚡ 500 ↔ 500 ↗ 10 mm  
 EAN 4000870 708118  
**708.11** 📦



**Lumix**

A++-A

incl. 1x11,5 W  
 1.000 lm, 2.700 K  
 24 V  
 ⚡ 500 ↔ 500 ↗ 10 mm  
 EAN 4000870 708125  
**708.12** 📦





⚙️ Weiß/Satin 🗪 Metall/Kunststoff  
 ⚙️ Blanc/Satiné 🗪 Métal/  
 Matière plastique  
 ⚙️ Wit/Satijn 🗪 Metaal/Kunststof

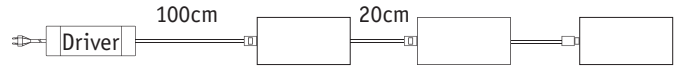

**Glow Basic**

incl. 1x8,0W  
 650lm, 2.700K  
 230/24V, incl. ⚡ 24VA  
 ⚡ 250 ↔ 400 ⚡ 7mm  
 EAN 4000870 708071  
**708.07**



**Glow Extension**

incl. 1x8,0W  
 650lm, 2.700K  
 DC 24V  
 ⚡ 250 ↔ 400 ⚡ 7mm  
 EAN 4000870 708088  
**708.08**



⚙️ Weiß/Satin 🗪 Metall/Kunststoff  
 ⚙️ Blanc/Satiné 🗪 Métal/  
 Matière plastique  
 ⚙️ Wit/Satijn 🗪 Metaal/Kunststof



**Ace Basic**

incl. 1x7,5W  
 580lm, 2.700K  
 230/24V, incl. ⚡ 24VA  
 ⚡ 100 ↔ 300 ⚡ 7mm  
 EAN 4000870 707760  
**707.76**



**Ace Extension**

incl. 1x7,5W  
 580lm, 2.700K  
 DC 24V  
 ⚡ 100 ↔ 300 ⚡ 7mm  
 EAN 4000870 707777  
**707.77**



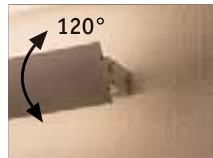

- ☞ Alu eloxiert ☒ Alu/Kunststoff
- ☞ Alu anodisé ☒ Alu/Matière plastique
- ☞ Alu geëloxeerd ☒ Alu/Kunststof

**Swing Kitchen Rail**

incl. 1x6,3 W  
765 lm, 2.700 K  
✗ 120°  
230 V  
⇅50 ⇄800 ↗65 mm  
EAN 4000870 708262  
**708.26**

A++-A

LED

incl.

IP23

W/W

☞

On/Off



- ☞ Alu matt/Schwarz ☒ Alu/Kunststoff
- ☞ Alu mat/Noir ☒ Alu/Matière plastique
- ☞ Alu mat/Zwart ☒ Alu/Kunststof



- ▶ LED-Schrankleuchte
- ▶ Klare Abdeckung mit Prismeneffekt
- ▶ Superflaches, hochwertiges Aluprofil
- ▶ Inkl. Touchschalter
- ▶ Einfache Befestigung über Montageclips
- ▶ Inkl. Power Supply

- ▶ Lampe pour meubles LED
- ▶ Excellente couverture avec un effet de prismes
- ▶ Profilé en aluminium de haute qualité extra-plat
- ▶ Interrupteur tactile inclus
- ▶ Fixation aisée grâce aux clips de montage
- ▶ Alimentation incluse

- ▶ LED-kastlamp
- ▶ Doorzichtige afdekking met prismaeffect
- ▶ Zeer plat, hoogwaardig aluprofiel
- ▶ Incl. touchschakelaar
- ▶ Eenvoudige bevestiging via montageclips
- ▶ Incl. Power Supply

**TriX**

A++-A

incl. 1x4,2 W  
340 lm, 3.000 K  
✗ 120°  
230/12 V, incl. -☒- 7 VA  
⇅12 ⇄465 ↗65 mm  
EAN 4000870 703984  
**703.98**

**TriX**

A++-A

incl. 1x4,8 W  
420 lm, 3.000 K  
✗ 120°  
230/12 V, incl. -☒- 7 VA  
⇅12 ⇄565 ↗65 mm  
EAN 4000870 704479  
**704.47**

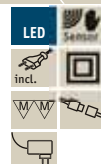
**TriX**

A++-A

incl. 1x5,7 W  
520 lm, 3.000 K  
✗ 120°  
230/12 V, incl. -☒- 7 VA  
⇅12 ⇄765 ↗65 mm  
EAN 4000870 704486  
**704.48**



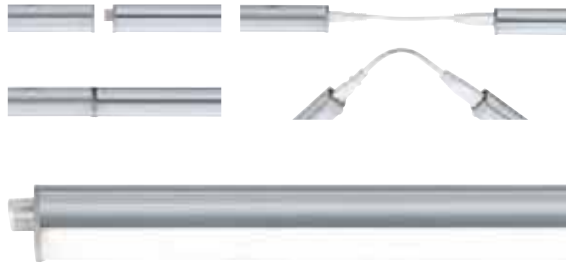

- 🔗 Satin  Alu/Kunststoff
- 🔗 Satiné  Alu/Matière plastique
- 🔗 Satijn  Alu/Kunststof

- ▶ Verkettbare LED-Lichtleiste mit transparenten Endkappen für ein optisch unterbrechungsfreies Lichtband. Die Leuchten lassen sich durch einen integrierten Verbindungsstecker aneinanderreihen. Jede Leuchte einzeln schaltbar. Einfach Installation mit Montage-Clips.
- ▶ Inkl. Zuleitung mit Eurostecker
- ▶ Inkl. Verbindungsleistung für Kurven oder Übergänge
- ▶ Minimale Abmessungen
- ▶ Réglette LED combinable avec embouts transparents pour une bande lumineuse sans interruption optique. Les luminaires se combinent l'un après l'autre grâce au connecteur intégré. Chaque luminaire s'allume individuellement. Pose facile grâce aux clips de montage.
- ▶ Fourni avec un câble d'alimentation doté d'un connecteur Euro
- ▶ Fourni avec le matériel de connexion pour courbes ou jonctions
- ▶ Dimensions minimales
- ▶ Aaneenschakelbare LED-lichtbalk met transparante eindkappen voor een optisch ononderbroken lichtband. De lampen kunnen met een geïntegreerde verbindingsstecker met elkaar worden verbonden. Elke lamp afzonderlijk schakelbaar. Eenvoudige installatie met montageclips.
- ▶ Incl. toevoerleiding met eurostecker
- ▶ Incl. verbindingsleiding voor bochten of overgangen
- ▶ Minimale afmetingen

Bond	A++-A	Bond	A++-A	Bond	A++-A	Bond	A++-A
incl. 1x5 W 370 lm, 4.000 K 230 V ⤴35 ⤵318 ⤶25 mm EAN 4000870 706060 <b>706.06</b>	   	incl. 1x8 W 720 lm, 4.000 K 230 V ⤴35 ⤵518 ⤶25 mm EAN 4000870 706121 <b>706.12</b>	   	incl. 1x12 W 950 lm, 4.000 K 230 V ⤴35 ⤵889 ⤶25 mm EAN 4000870 706138 <b>706.13</b>	   	incl. 1x15 W 1.200 lm, 4.000 K 230 V ⤴35 ⤵1.146 ⤶25 mm EAN 4000870 706145 <b>706.14</b>	   



- 🔗 Alu matt  Alu/Kunststoff
- 🔗 Alu mat  Alu/Matière plastique
- 🔗 Alu mat  Alu/Kunststof

- ▶ LED-Lichtleiste mit Touch-Schalter
- ▶ Inkl. satiniertem Diffusor für gleichmäßige Lichtverteilung
- ▶ Komfortable Montage dank Cliphalterung
- ▶ Ideal für 50cm (70402) / 30cm (70401) Schrank- oder Fachbodenbreiten
- ▶ Mit blau beleuchtetem Touch-Schalter zur schnelleren Orientierung im Dunkeln
- ▶ Réglette lumineuse LED avec interrupteur tactile
- ▶ Diffuseur satiné inclus pour une répartition plus uniforme de la lumière
- ▶ Montage facile grâce aux pinces
- ▶ Idéal pour un meuble ou une plinthe de 50cm de large (70402) / 30cm (70401)
- ▶ Interrupteur tactile équipé d'une lumière bleue pour un repérage facile dans l'obscurité
- ▶ LED-lichtbalk met touch-schakelaar
- ▶ Incl. gesatineerde diffusor voor gelijkmatige lichtverdeling
- ▶ Comfortabele montage dankzij cliphouder
- ▶ Ideaal voor 50 cm (70402) / 30cm (70401) kast- of vakkbreedtes
- ▶ Met blauw verlichte touch-schakelaar voor snellere oriëntatie in het donker

JetLine	A++-A	JetLine	A++-A	JetLine	A++-A	JetLine	A++-A
incl. 1x3,5 W 170 lm, 2.700 K ∠ 120° 230/12 V, incl. ⚡ 3,6 VA ⤴14 ⤵260 ⤶17,5 mm EAN 4000870 704011 <b>704.01</b>	    	incl. 1x5,5 W 310 lm, 2.700 K ∠ 120° 230/12 V, incl. ⚡ 7 VA ⤴14 ⤵460 ⤶17,5 mm EAN 4000870 704028 <b>704.02</b>	    	incl. 1x10 W 550 lm, 2.700 K ∠ 120° 230/12 V, incl. ⚡ 12 VA ⤴17 ⤵560 ⤶14 mm EAN 4000870 704455 <b>704.45</b>	    	incl. 1x10,5 W 620 lm, 2.700 K ∠ 120° 230/12 V, incl. ⚡ 12 VA ⤴14 ⤵660 ⤶17 mm EAN 4000870 704462 <b>704.46</b>	    

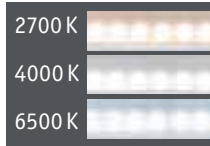

- ☞ Alu matt Alu/Kunststoff
- ☞ Alu mat Alu/Matière plastique
- ☞ Alu mat Alu/Kunststof



- ▶ LED-Unterbauleuchte für die Küchenbeleuchtung und andere Einsatzzwecke. Dreistufige Auswahl der weißen Lichtfarbe (Warmweiß, Neutralweiß, Tageslichtweiß). Gleichmäßige Ausleuchtung der Arbeitsfläche durch asymmetrischen Lichtaustritt
- ▶ Hochwertiges Alugehäuse
- ▶ Beleuchteter Touchschalter (blau)
- ▶ Einfache Montage durch Schlüsselloch-Befestigung
- ▶ Luminaire de sous-meuble à LED pour l'éclairage de la cuisine et autres applications. Sélection à trois niveaux de la température de couleur blanche (blanc chaud, blanc neutre, blanc lumière du jour). Éclairage uniforme du plan de travail grâce à un flux de lumière asymétrique
- ▶ Boîtier en aluminium de haute qualité
- ▶ Interrupteur à effleurement avec voyant (bleu)
- ▶ Montage simple par fixation en trou de serrure
- ▶ LED-onderbouwlamp voor keukenverlichting en andere toepassingen. Drietraps selectie van de witte lichtkleur (warmwit, neutraal wit, daglicht wit). Gelijkmatige verlichting van het werkberook door asymmetrisch uitdrendend licht
- ▶ Hoogwaardige aluminiumbehuizing
- ▶ Verlichte touchschakelaar (blauw)
- ▶ Eenvoudige montage door sleutelgatbevestiging

**ChangeLine** A++-A

incl. 1x3,8 W  
280 lm, 2.700 - 6.500 K  
∠ 120°

230/12 V,  
incl. 8,4 VA  
⌀18 ↔400 ⌀40 mm  
EAN 4000870 705957  
**705.95**

**ChangeLine** A++-A

incl. 1x4,4 W  
330 lm, 2.700 - 6.500 K  
∠ 120°

230/12 V,  
incl. 8,4 VA  
⌀18 ↔500 ⌀40 mm  
EAN 4000870 705964  
**705.96**

**ChangeLine** A++-A

incl. 1x5 W  
380 lm, 2.700 - 6.500 K  
∠ 120°

230/12 V,  
incl. 8,4 VA  
⌀18 ↔600 ⌀40 mm  
EAN 4000870 705971  
**705.97**

**ChangeLine** A++-A

incl. 1x6,2 W  
480 lm, 2.700 - 6.500 K  
∠ 120°

230/12 V,  
incl. 8,4 VA  
⌀18 ↔800 ⌀40 mm  
EAN 4000870 705988  
**705.98**

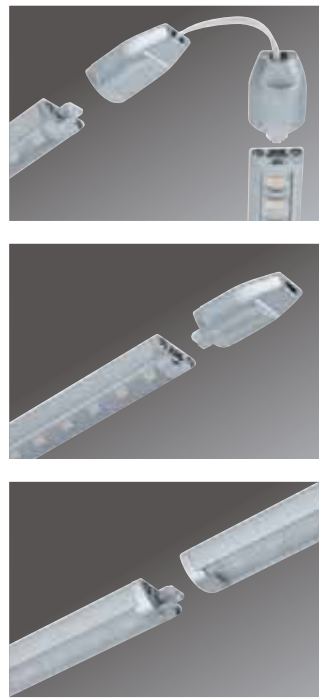

📌 Alu/Satin 📌 Alu/Acryl  
 📌 Alu/Satiné 📌 Alu/Acryl  
 📌 Alu/Satijn 📌 Alu/Acryl

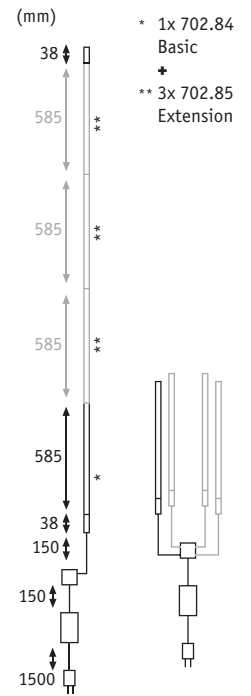

- ▶ **Komplett-Set zur Unterschrankbeleuchtung mit lichtstarker LED-Technik**
- ▶ **Hochwertiges Aluminium-Profil mit satiniertes Abdeckung**
- ▶ **Basis-Set ist um 3 Erweiterungen ergänzbar (max. 4 Leisten in einem System)**
- ▶ **Einfache Montage durch Cliphalterung und Stecksystem**

- ▶ **Kit complet pour l'éclairage de sous-meubles avec la technique LED de forte puissance**
- ▶ **Profilé haut de gamme en aluminium avec diffuseur satiné**
- ▶ **3 extensions peuvent être ajoutées au kit de base (4 barrettes maximum par système)**
- ▶ **Montage simple par clip et système de connexion**

- ▶ **Complete set voor onderkastverlichting met lichtsterke LED-techniek**
- ▶ **Hoogwaardig aluminiumprofiel met gesatineerde afdekking**
- ▶ **Basisset kan met 3 uitbreidingen worden uitgebreid (max. 4 lijsten in een systeem)**
- ▶ **Eenvoudige montage door cliphouder en steekstelsysteem**



**LinkLight Basic 24V**

incl. 1x7,5 W  
 380 lm, 3.000 K  
 <math>\sphericalangle 95^\circ</math>, 260 cd  
 230/24 V, incl. ⚡ 30 VA  
 ⌀10 ⇔660 ⌀22 mm  
 EAN 4000870 702840  
**702.84**

A++-A

LED

incl.

On/Off



**LinkLight Extension 24V**

incl. 1x7,5 W  
 380 lm, 3.000 K  
 <math>\sphericalangle 95^\circ</math>, 260 cd  
 24 V  
 ⌀10 ⇔625 ⌀22 mm  
 EAN 4000870 702857  
**702.85**

A++-A

LED

On/Off





- Alu matt Alu/Kunststoff
- Alu mat Alu/Matière plastique
- Alu mat Alu/Kunststof

- ▶ LED-Schubladenleuchte mit Distanz-Sensor
- ▶ Ideal zur Beleuchtung von Schubladen und Schränken
- ▶ Distanz-Sensor schaltet beim Öffnen/Schließen automatisch - Schaltdistanz 5cm
- ▶ Minimale Aufbauhöhe
- ▶ Einfache Befestigung mit Nutklötzen
- ▶ Eclairage brillant LED pour armoire
- ▶ Excellente couverture avec un effet de prismes
- ▶ Le capteur de distance commute automatiquement lors de l'ouverture / fermeture - distance de commutation 5cm
- ▶ Interrupteur tactile inclus
- ▶ Fixation aisée grâce aux clips de montage
- ▶ LED-ladelamp met afstandsensor
- ▶ Ideaal voor verlichting van lades en kasten
- ▶ Afstandsensor schakelt bij openen/sluiten automatisch. Schakelafstand 5cm
- ▶ Minimale opbouwhoogte
- ▶ Eenvoudige bevestiging met moerblokken

### SenseLight

incl. 1x8,3 W  
287 lm, 2.700 K  
∠ 120°  
230/12 V, incl. 12 VA  
∅13 ∅500 ∅31 mm  
EAN 4000870 703991  
**703.99**

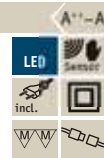

### SenseLight

incl. 1x10 W  
640 lm, 2.700 K  
∠ 120°  
230/12 V, incl. 12 VA  
∅13 ∅600 ∅31 mm  
EAN 4000870 704448  
**704.44**

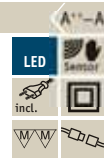

- Alu matt Alu/Kunststoff
- Alu mat Alu/Matière plastique
- Alu mat Alu/Kunststof

- ▶ Kürzbare LED-Kleiderstangenleuchte
- ▶ Bequemes Schalten durch integrierten Bewegungsmelder
- ▶ Hochwertiges Aluminium-Profil, kürzbar mit Metallsäge
- ▶ Inkl. Softtop für geräuschloses Gleiten der Bügel
- ▶ Montageflansch mit integrierter Stromzuführung
- ▶ Tringle LED raccourcissable
- ▶ Allumage aisé grâce au détecteur de mouvements
- ▶ Profilé en aluminium de haute qualité, raccourcissable avec une scie à métaux
- ▶ Inclus protection pour limiter le bruit des cintres
- ▶ Montage aisé grâce au pré-cablage 230V
- ▶ Inkortbare LED-kledingstanglamp
- ▶ Comfortabel schakelen door geïntegreerde bewegingsmelders
- ▶ Hoogwaardig aluminium-profiel, inkortbaar met metaalzaag
- ▶ Incl. softtop voor voor stil glijden van de beugels
- ▶ Montageflens met geïntegreerde voeding

### DressLight

incl. 1x6,5 W  
300 lm, 2.700 K  
∠ 120°  
230/12 V, incl. 7 VA  
∅31 ∅600 ∅19 mm  
EAN 4000870 704035  
**704.03**



### DressLight

incl. 1x11,5 W  
640 lm, 2.700 K  
∠ 120°  
230/12 V, incl. 12 VA  
∅31 ∅1.100 ∅19 mm  
EAN 4000870 704042  
**704.04**





- 🔧 Alu 📦 Alu/Kunststoff
- 🔧 Alu 📦 Alu/Matière plastique
- 🔧 Alu 📦 Alu/Kunststof

- ▶ Kürzbare LED-Kleiderstangenleuchte mit integriertem Bewegungsmelder schafft Übersicht im Schrank. Vereinfachte Montage durch Batteriebetrieb. DressLight lässt sich wie eine gewöhnliche Kleiderstange auf das gewünschte Schrankmaß kürzen.
  - ▶ Betrieb mit 4x1,5V AAA (exkl.)
  - ▶ Kürzbar bis zu 10cm Abstand vom Sensor
  - ▶ Klare Abdeckung zum Schutz der LED
  - ▶ Bei gleichmäßiger Lastverteilung max. 20kg
  - ▶ Inklusive Stangen-Haltern
- ▶ Tringle LED pour vêtements raccourcissable avec détecteur de mouvement intégré pour un éclairage à l'intérieur de l'armoire. Installation facilité par l'utilisation de piles. DressLight peut être raccourci à la longueur souhaitée comme une tringle ordinaire.
  - ▶ Fonctionne avec 4x1,5V AAA (non incluses)
  - ▶ Raccourcissable jusqu'à environ 10 cm du capteur
  - ▶ Revêtement clair pour protéger la LED
  - ▶ Conçu pour une charge uniforme de 20kg max.
  - ▶ Supports inclus
- ▶ Inkortbare LED-kledingstangverlichting met integreerbare bewegingsmelder voor overzicht in uw kast. Vereenvoudigde montage door batterijgebruik. DressLight kan als een gewone kledingstang tot de gewenste kastmaat worden ingekort.
  - ▶ Bedrijf met 4x1,5V AAA (excl.)
  - ▶ Inkortbaar tot 10cm afstand van de sensor
  - ▶ Heldere afdekking ter bescherming van de LED
  - ▶ Bij gelijkmatige lastverdeling max. 20 kg
  - ▶ Inclusief stanghouders

#### DressLight Battery

incl. 1x0,9W  
35 lm, 2.700 K  
∠ 120°  
AAA/1,5V (Micro) × 4  
⌀30 ↔600 ↗16 mm  
EAN 4000870 705018  
**705.01** 📦

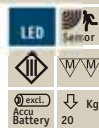

#### DressLight Battery

incl. 1x1,35 W  
45 lm, 2.700 K  
∠ 120°  
AAA/1,5V (Micro) × 4  
⌀30 ↔1.100 ↗16 mm  
EAN 4000870 704998  
**704.99** 📦

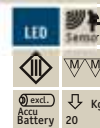

- 🔗 Silber 📦 Kunststoff
- 🔗 Argent 📦 Matière plastique
- 🔗 Zilver 📦 Kunststof



- ▶ Optimal für Schiebetüren: LED-Schrankleuchte mit Gleitrolle für den Batteriebetrieb. Die Gleitrolle schaltet die Leuchte beim Öffnen einer Schranktür automatisch ein und wieder aus. Einfach Licht wo Sie es brauchen.
  - ▶ Einfache Befestigung abnehmbaren Montageboden mit Klebepads oder Schrauben fixieren
  - ▶ Leicht zugängliches Batteriefach
  - ▶ Betrieb mit 4x1,5V AAA (exkl.)
  - ▶ Klare Abdeckung und Reflektor für optimierte Lichtausbeute
- ▶ Idéal pour les portes coulissantes : petit éclairage LED avec roulette pour le fonctionnement de la batterie. La roulette allume et éteint automatiquement la lumière à l'ouverture et à la fermeture de la porte de l'armoire. Un éclairage facile là où vous en avez besoin.
  - ▶ Fixation simple au sol avec des pastilles autocollantes ou des vis
  - ▶ Compartiment de la batterie facilement accessible
  - ▶ Fonctionne avec 4x1,5V AAA (non incluses)
  - ▶ Revêtement et réflecteur clairs pour un rendement lumineux optimal
- ▶ Optimaal voor schuifdeuren: LED-kleinlicht met glijrol voor batterijgebruik. De glijrol schakelt de lamp door openen van een kastdeur automatisch in en weer uit. Eenvoudig: licht waar u het nodig heeft.
  - ▶ Eenvoudige bevestiging van afneembare montagevloeren met hechtpads of schroeven fixeren
  - ▶ Eenvoudig toegankelijk batterijvak
  - ▶ Bedrijf met 4x1,5V AAA (excl.)
  - ▶ Heldere afdekking en reflector voor geoptimaliseerde lichtrendement

#### SnapLED

incl. 1x0,33 W  
25 lm, 2.700 K  
✗ 120°  
AAA/1,5V (Micro) x 4  
⌀22 ↔53 ↻95 mm  
EAN 4000870 704981  
**704.98**



- 🔗 Alu 📦 Alu/Kunststoff
- 🔗 Alu 📦 Alu/Matière plastique
- 🔗 Alu 📦 Alu/Kunststof



- ▶ LED-Schrankleuchte mit Magnetkontakt für den Batteriebetrieb. Der Magnetkontakt schaltet die Leuchte beim Öffnen einer Schranktür automatisch ein und wieder aus. Einfach Licht wo Sie es brauchen.
  - ▶ Einfache Montage mit Klebepads
  - ▶ Betrieb mit 3x1,5V AAA (exkl.)
  - ▶ Klare Abdeckung und Reflektor für optimierte Lichtausbeute
- ▶ Petit éclairage LED avec contact magnétique pour le fonctionnement de la batterie. Le contact magnétique allume et éteint automatiquement la lumière à l'ouverture et à la fermeture de la porte de l'armoire. Un éclairage facile là où vous en avez besoin.
  - ▶ Montage aisé grâce à des pastilles autocollantes
  - ▶ Fonctionne avec 3x1,5V AAA (non incluses)
  - ▶ Revêtement et réflecteur clairs pour un rendement lumineux optimal
- ▶ LED-kleinlicht met magneetcontact voor batterijgebruik. Het magneetcontact schakelt de lamp door openen van de kastdeur automatisch in en weer uit. Eenvoudig: licht waar u het nodig heeft.
  - ▶ Eenvoudige montage met hechtpads
  - ▶ Bedrijf met 3x1,5 V AAA (excl.)
  - ▶ Heldere afdekking en reflector voor geoptimaliseerde lichtrendement

#### TriLED

incl. 1x0,18 W  
7.400 - 9.400 K  
✗ 120°  
AAA/1,5V (Micro) x 3  
⌀24 ↔66 ↻65 mm  
EAN 4000870 705001  
**705.00**





- ▶ Multifunktionale Batterieleuchten mit vielfältigen Einsatzmöglichkeiten in Möbeln oder unter Hängeschränken für gleichmäßiges Arbeitslicht, gerichtete Spot-Beleuchtung oder hilfreiches Orientierungslicht. Je nach Modell dimmbar, mit schwenkbaren Spotköpfen oder Bewegungsmelder ausgestattet.
  - ▶ Inkl. Montageplatte für einfachen Batteriewechsel
  - ▶ Einfache Befestigung mit Klebe- oder Klett pads
- ▶ Luminaires à pile multifonctionnels avec de nombreuses possibilités d'utilisation dans les meubles ou sous les placards, fournissant une lumière de travail uniforme, un éclairage spot ciblé ou un éclairage de balisage.
  - ▶ Fourni avec une plaque de montage pour un remplacement facile des piles
  - ▶ Fixation facile avec des pattes adhésives ou velcro
- ▶ Multifunctionele batterijlampen met veelzijdige toepassingsmogelijkheden in meubels of onder hangkasten voor gelijkmatig werklicht, gerichte spotverlichting of handige oriëntatieverlichting. Afhankelijk van het model dimbaar, met zwenkbare spotkoppen of bewegingsmelder uitgerust.
  - ▶ Incl. montageplaat voor eenvoudige batterijwissel
  - ▶ Eenvoudige bevestiging met kleef- of klittenbandpads



**Jiggle** A++-A

incl. 3×0,18 W  
 3×22 lm, 3.000 K  
 ∠ 105°  
 AAA/1,5V (Micro) × 6  
 ∅35 ∅300 ∅60 mm  
 EAN 4000870 706350  
**706.35**

Chrom matt Kunststoff  
 Chrome mat Matière plastique  
 Chroom mat Kunststof

LED

incl.

excl.  
AAA Battery

On/Off



**Rotate** A++-A

incl. 3×0,2 W  
 3×18 lm, 3.000 K  
 ∠ 105°  
 AAA/1,5V (Micro) × 6  
 ∅50 ∅310 ∅60 mm  
 EAN 4000870 706367  
**706.36**

Anthrazit/Chrom matt Kunststoff  
 Anthracite/Chrome mat  
 Matière plastique  
 Antraciet/Chroom mat Kunststof

LED

incl.

excl.  
AAA Battery

On/Off

**SmartLight**

A++-A

incl. 1x1,6 W  
140 lm, 3.000 K  
✗ 100°

AA/1,5 V (Mignon) × 3  
⇅27 ⇄250 ↗55 mm  
EAN 4000870 706381

**706.38**

☞ Chrom matt ☒ Kunststoff  
☞ Chrome mat ☒ Matière plastique  
☞ Chroom mat ☒ Kunststof

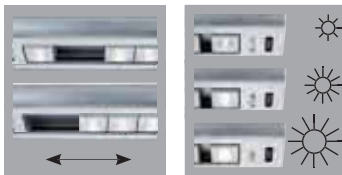
**Slide bar**

A++-A

incl. 3x0,5 W  
3x40 lm, 3.000 K  
✗ 20°

AA/1,5 V (Mignon) × 6  
⇅31,5 ⇄304 ↗80 mm  
EAN 4000870 706404

**706.40**

☞ Chrom matt ☒ Kunststoff  
☞ Chrome mat ☒ Matière plastique  
☞ Chroom mat ☒ Kunststof

**Rotate**

A++-A

incl. 1x1 W  
66 lm, 3.000 K  
✗ 20°

AA/1,5 V (Mignon) × 3  
ø92 ↗72 mm  
EAN 4000870 706374

**706.37**

☞ Chrom matt ☒ Kunststoff  
☞ Chrome mat ☒ Matière plastique  
☞ Chroom mat ☒ Kunststof

**ButtonLED**

A++-A

incl. 1x0,6 W  
70 lm, 3.000 K  
✗ 105°

AAA/1,5V (Micro) × 3  
⇅41 ø88 mm  
EAN 4000870 706398

**706.39**

☞ Anthrazit ☒ Kunststoff  
☞ Anthracite ☒ Matière plastique  
☞ Antraciet ☒ Kunststof





- ↳ Multicolor Kunststoff
- ↳ Multicolor Matière plastique
- ↳ Multicolor Kunststof

- ▶ Magic Würfel Optik
- ▶ Inkl. Schlüsselanhänger

- ▶ Look dé magique
- ▶ Avec porte-clefs

- ▶ Magic Cube optiek
- ▶ Incl. Sleutelhanger



**Magic Cube LED Light**

incl. 1x0,3W  
 5,5 lm, 10.000 K  
 AG 13/1,5V x 3  
 ∅20 ↔20 ↗60 mm  
 EAN 4000870 789674  
**789.67** **new**



- ↳ Blau Kunststoff
- ↳ Bleu Matière plastique
- ↳ Blauw Kunststof

- ▶ 2 Dimmstufen: 50% & 100%
- ▶ Inkl. Schlüsselanhänger

- ▶ 2 niveaux de gradation : 50 % & 100 %
- ▶ Avec porte-clefs

- ▶ 2 dimniveaus: 50% en 100%
- ▶ Incl. Sleutelhanger



**Mini Key Flashlight**

incl. 1x1W  
 20lm, 5.000 K  
 CR 2032/3V x 2  
 ∅12 ↔38 ↗60 mm  
 EAN 4000870 789681  
**789.68** **new**



- ↳ Rot Kunststoff
- ↳ Rouge Matière plastique
- ↳ Rood Kunststof

- ▶ Magnet Clip kann an Kleidung, Taschen und metallischen Gegenständen befestigt werden
- ▶ 3 Farbmodi: Weiß, Rot, Rot blinkend

- ▶ Magnet Clip se fixe aux vêtements, aux sacs et aux objets métalliques
- ▶ 3 modes de couleur : Blanc, Rouge, Rouge clignotant

- ▶ Magnet Clip kan worden bevestigd aan kleding, tassen en metalen voorwerpen
- ▶ 3 kleurmodi: Wit, Rood, Rood knipperend



**Magnet Clip Light**

incl. 1x1,2W  
 11 lm, 6.000 K  
 CR 2032/3V x 2  
 ∅18 ↔33 ↗79 mm  
 EAN 4000870 789698  
**789.69** **new**





- 👉 Weiß 🗪 Kunststoff
- 👉 Blanc 🗪 Matière plastique
- 👉 Wit 🗪 Kunststof

- ▶ Bewegungssensor: erfasst Bewegungen innerhalb von 5m
- ▶ Inkl. Dämmerungssensor, schaltet erst bei Dunkelheit ein
- ▶ Erfassungswinkel bis zu 120 Grad
- ▶ Schaltet für 25 Sek. Licht ein
- ▶ Détecteur de mouvement : capte les mouvements dans un rayon de 5 m
- ▶ Avec détecteur crépusculaire, s'allume seulement dans l'obscurité
- ▶ Angle de diffusion jusqu'à 120 °
- ▶ S'allume pendant 25 sec .
- ▶ Bewegingsensor: detecteert bewegingen binnen een straal van 5 m
- ▶ Incl. schemersensor, schakelt pas in wanneer het donker is
- ▶ Detectiehoek tot 120 graden
- ▶ Schakelt 25 s lang het licht aan



#### Motion Sensor Light

incl. 1x0,45 W  
25 lm, 8.000 K  
AAA/1,5V (Micro) x 3  
⌀16 ↔75 ↗75 mm  
EAN 4000870 789711  
**789.71 new**



- 👉 Orange/Schwarz 🗪 Kunststoff
- 👉 Orange/Noir 🗪 Matière plastique
- 👉 Oranje/Zwart 🗪 Kunststof

- ▶ 3 Einstellungen möglich: ausklappbarer Fuß, Haken oder Magnet zum Hängen, schwenkbar
- ▶ 3 réglages possibles : pied escamotable, suspension par crochet ou aimant, orientable
- ▶ 3 instellingen mogelijk: uitklapbare voet, haak of magneet om op te hangen, zwenkbaar



#### Work Light

incl. 1x1,8 / 1x2,7 W  
150/50 lm, 6.500 - 9.000 K  
AAA/1,5V (Micro) x 4  
⌀20 ↔50 ↗160 mm  
EAN 4000870 789704  
**789.70 new**





- 🔧 Alu matt 🏠 Metall/Kunststoff
- 🔧 Alu mat 🏠 Métal/Matière plastique
- 🔧 Alu mat 🏠 Metaal/Kunststof

- ▶ Schwenkbare Unterbauleuchte mit integriertem Schalter
- ▶ Gezielte Innenschrankbeleuchtung durch 120° Schwenkwinkel
- ▶ Hohe Energieeffizienz
- ▶ Montagefreundliche Schlüssellochbefestigung
- ▶ Inkl. Zuleitung mit Eurostecker
- ▶ Eclairage sous-meuble orientable avec interrupteur intégré
- ▶ Spécifique pour l'éclairage des armoires avec un angle de 120°
- ▶ Haute efficacité énergétique
- ▶ Montage aisé
- ▶ Fourni avec un câble d'alimentation doté d'un connecteur Euro
- ▶ Zwenkbare onderbowlamp met geïntegreerde schakelaar
- ▶ Gerichte interne kastverlichting door 120° zwenkhoek
- ▶ Grote energie-efficiëntie
- ▶ Eenvoudig te monteren sleutelgatbevestiging
- ▶ Incl. toevoerleiding met eurostecker



#### WaveLine

incl. 1×8 W, G5, <A>  
 480 lm, 3.000 K  
 230 V  
 ⌀45 ↔350 ↗85 mm  
 EAN 4000870 704059  
**704.05** 📦  
 💡 885.08

< A-A



#### WaveLine

incl. 1×13 W, G5, <A>  
 980 lm, 3.000 K  
 230 V  
 ⌀45 ↔580 ↗85 mm  
 EAN 4000870 704066  
**704.06** 📦  
 💡 885.13

< A-A





# Outdoor

- 248 Plug & Shine
- 263 Mobile
- 273 House 230V
- 287 12V
- 294 Solar



248 Plug & Shine



266 Placido



273 House



294 Solar Pandora Led



### Plug & Shine: das Steck-System für faszinierendes Licht im Garten und auf der Terrasse

Plug & Shine ist die perfekte Lösung für die individuelle Licht-Inszenierung von Lieblingsecken und -pflanzen am Haus, im Garten und auf der Terrasse. Das 24V-LED-Gleichspannungs-Kabelsystem ist kinderleicht zu installieren und sicher. Anders als bei 230V-Installationen müssen Gartenfreunde keine tiefen, mehrfach gesicherten Gräben ausheben – die Plug & Shine-Kabel dürfen auch oberirdisch liegen und sind mit IP 68 höchstmöglich gegen das Eindringen von Wasser geschützt. Das clevere Kabelsystem ist bis zu 50m Länge erweiterbar. Damit sind Gartenliebhaber völlig flexibel bei der Positionierung und Erweiterung ihrer Beleuchtung – einfach zusammenstecken und das Licht wirken lassen. Alle Leuchten sind dimmbar, korrosionsgeschützt und vor Wasser geschützt (IP 65/67). Per Fernbedienung oder ZigBee 3.0 Steuerung können Sie Ihre Leuchten schalten und dimmen.

- ▶ Lichtstarke und hochwertig ausgeführte Außenleuchten
- ▶ Auf den jeweiligen Anwendungszweck passende Lichtlösungen für den Garten und die Terrasse
- ▶ Einfacher Anschluss durch das geschützte Paulmann 24V-Steckersystem

### Plug & Shine : le système enfichable pour un éclairage fascinant du jardin et de la terrasse

Plug & Shine est la solution idéale pour la mise en scène personnalisée de l'éclairage de vos coins préférés et de vos plantes, à l'intérieur, dans le jardin et sur la terrasse. Le système de câble à courant continu et LED 24V est extrêmement simple à installer et sûr. À la différence des installations en 230V, les adeptes du jardin ne doivent pas creuser de profondes tranchées multi-sécurisées - les câbles Plug & Shine peuvent rester en surface et bénéficient de la plus haute protection IP68 contre l'infiltration d'eau. Le système de câble intelligent est extensible jusqu'à 50 m. Les adeptes du jardin bénéficient d'une très grande souplesse dans le choix de l'emplacement et l'extension de leur éclairage - il suffit de les raccorder et de laisser place à la lumière. Tous les luminaires sont gradables, protégés contre la corrosion et étanches à l'eau (IP 65/67). Vous pouvez commuter ou varier l'intensité de vos luminaires par télécommande ou commande ZigBee 3.0.

- ▶ Luminaires d'extérieur puissants et de haute qualité
- ▶ Des solutions d'éclairage adaptées à chaque situation, pour le jardin et la terrasse
- ▶ Raccordement simple grâce au système d'enfichage protégé 24V Paulmann

### Plug & Shine: het steekstelsysteem voor fascinerend licht in de tuin en op het terras

Plug & Shine is de perfecte oplossing voor de individuele verlichting van lievelingshoeken en -planten rondom het huis, in de tuin en op het terras. Het installeren van het 24V-LED gelijkspanningskabelsysteem is heel eenvoudig en veilig. In tegenstelling tot de 230V-installaties moeten tuinvrienden geen diepe, extra beveiligde greppels graven – de Plug & Shine-kabels mogen ook bovengronds liggen en zijn met IP 68 maximaal tegen binnendringen van water beschermd. Het slimme kabelsysteem kan tot 50 m worden verlengd. Dit verschaft tuinliefhebbers volledige flexibiliteit voor het plaatsen en uitbreiden van hun verlichting – gewoon in elkaar steken en het licht laten werken. Alle lampen zijn dimbaar, tegen corrosie beschermd en waterdicht (IP 65/67). Per afstandsbediening of ZigBee 3.0 besturing kunt u uw armaturen schakelen en dimmen.

- ▶ Lichtsterke en hoogwaardig uitgevoerde buitenverlichting
- ▶ Lichtoplossingen voor tuin en terras aangepast aan het nagestreefde doel
- ▶ Eenvoudige aansluiting door het beschermde Paulmann 24V-stekkersysteem



- ▶ Unterwasser-Spot IP68 für Teiche  
- Installation unter Wasser durch Metallteller

- ▶ Spot submersible IP68 pour bassins  
- Installation immergée via partie métallique

- ▶ Onderwaterspot IP68 voor vijvers -  
installatie onder water door metalen schaal



**Plug & Shine Pond Spot**

incl. 1x4 W  
400 lm, 3.000 K  
∠ 25°  
24 V  
∅120 ∅200 mm  
EAN 4000870 942093  
**942.09 new**

A++-A

LED

IP68



rostfrei

- ↳ Schwarz Alu
- ↳ Noir Alu
- ↳ Zwart Alu

- ▶ Ideal für die Ausleuchtung von hohen Bäumen

- ▶ Convient parfaitement à l'éclairage de grands arbres

- ▶ Ideaal voor het verlichten van hoge bomen



**Plug & Shine Spotlight Cone**

incl. 1x6,8 W  
667 lm, 3.000 K  
∠ 20°  
24 V  
∅420 ∅110 mm  
EAN 4000870 939239  
**939.23 new**

A++-A

LED

IP67



rostfrei

- ↳ Silber/Anthrazit Alu Druckguss
- ↳ Argent/Anthracite Alu moulé sous pression
- ↳ Zilver/Antraciet Alu drukgegoten

- ▶ Ideal für die Ausleuchtung von kleineren Bäumen und Sträuchern

- ▶ Convient parfaitement à l'éclairage de petits arbres et arbustes

- ▶ Ideaal voor het verlichten van kleinere bomen en struiken



**Plug & Shine Spotlight Cone**

incl. 1x6,8 W  
667 lm, 3.000 K  
∠ 40°  
24 V  
∅420 ∅110 mm  
EAN 4000870 939246  
**939.24 new**

A++-A

LED

IP67



rostfrei

- ↳ Silber/Anthrazit Alu Druckguss
- ↳ Argent/Anthracite Alu moulé sous pression
- ↳ Zilver/Antraciet Alu drukgegoten



- 🔧 Anthrazit 🏠 Alu
- 🔧 Anthracite 🏠 Alu
- 🔧 Antraciet 🏠 Alu

- ▶ Ideal für die Ausleuchtung von Büschen und Beeten

- ▶ Convient parfaitement à l'éclairage d'arbustes et de massifs

- ▶ Ideaal voor het verlichten van struiken en perken

**Plug & Shine Spotlight**

A++-A

incl. 1x6 W  
520 lm, 3.000 K  
∠ 100°  
24 V  
⌀290 ø52 mm  
EAN 4000870 939345  
**939.34 new**

LED

IP67



rostfrei

**Plug & Shine Spotlight**

A++-A

incl. 1x6 W  
520 lm, 4.000 K  
∠ 100°  
24 V  
⌀290 ø52 mm  
EAN 4000870 939352  
**939.35 new**

LED

IP67



rostfrei



- ▶ Starter-Sets für den Einstieg in das System inkl. 3 Leuchten, 5 Meter Kabel mit 4 Ausgängen und einem Trafo für Erweiterungsmöglichkeiten
- ▶ Erweiterbar

- ▶ Kits de démarrage : comprend 3 luminaires, 5m de câble avec 4 sorties et un transformateur pour d'éventuelles extensions
- ▶ Extensible

- ▶ Startersets voor de instap in het systeem incl. 3 lampen, 5 meter kabel met 4 uitgangen en een trafo voor uitbreidingsmogelijkheden
- ▶ Uitbreidbaar

**Plug & Shine Spot Sting Set**

A++-A

incl. 3x6 W  
3x520 lm, 3.000 K  
∠ 100°  
24 V, incl. ⚡75 VA  
EAN 4000870 936962  
**936.96 new**

LED

IP44

IP67



- 🔗 Anthrazit 🏠 Alu
- 🔗 Anthracite 🏠 Alu
- 🔗 Antraciet 🏠 Alu

▶ Kleiner flexibler Gartenspot für Lichtakzente in Beeten oder Kübeln

▶ Petit spot de jardin flexible pour écl. massifs ou jardinières

▶ Kleine flexibele tuinspot voor lichtaccenten in perken of plantenbakken



**Plug & Shine Spot Plantini**

incl. 1x2,5W  
200lm, 3.000K  
↙ 45°  
24V  
⌀223 mm ø21 mm ↗77 mm  
EAN 4000870 939970  
**939.97** 🚚 **new**

A++-A



**Plug & Shine Spot Plantini**

incl. 1x2,5W  
230lm, 4.000K  
↙ 45°  
24V  
⌀223 mm ø21 mm ↗77 mm  
EAN 4000870 939963  
**939.96** 🚚 **new**

A++-A



- ▶ Starter-Sets für den Einstieg in das System inkl. 3 Leuchten, 5 Meter Kabel mit 4 Ausgängen und einem Trafo für Erweiterungsmöglichkeiten
- ▶ Erweiterbar

- ▶ Kits de démarrage : comprend 3 luminaires, 5m de câble avec 4 sorties et un transformateur pour d'éventuelles extensions
- ▶ Extensible

- ▶ Startersets voor de instap in het systeem incl. 3 lampen, 5 meter kabel met 4 uitgangen en een trafo voor uitbreidingsmogelijkheden
- ▶ Uitbreidbaar



**Plug & Shine Spot Plantini Set**

incl. 3x2,5W  
3x200lm, 3.000K  
↙ 45°  
24V  
⌀223 mm ø21 mm ↗77 mm ↔5 m  
EAN 4000870 941546  
**941.54** **new**

A++-A



**Plug & Shine Spot Plantini Set**

incl. 3x2,5W  
3x230lm, 4.000K  
↙ 45°  
24V  
⌀223 mm ø21 mm ↗77 mm ↔5 m  
EAN 4000870 941553  
**941.55** **new**

A++-A



- ▶ Extension-Sets für den Systemausbau inkl. 3 Leuchten, 5 Meter Kabel mit 4 Ausgängen und einem Trafo für Erweiterungsmöglichkeiten

- ▶ Kits d'extension du système : comprend 3 luminaires, 5 m de câble avec 4 sorties et un transformateur pour d'éventuelles extensions

- ▶ Uitbreidingssets voor de systeemuitbreiding incl. 3 lampen, 5 meter kabel met 4 uitgangen en een trafo voor uitbreidingsmogelijkheden



**Plug & Shine Spot Plantini Extension Set**

incl. 3x2,5W  
3x200lm, 3.000K  
↙ 45°  
230/24V, incl. ⚡ 21VA  
⌀223 mm ø21 mm ↗77 mm ↔5 m  
EAN 4000870 941560  
**941.56** **new**

A++-A

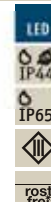

**Plug & Shine Spot Plantini Extension**

incl. 3x2,5W  
3x230lm, 4.000K  
↙ 45°  
230/24V, incl. ⚡ 21VA  
⌀223 mm ø21 mm ↗77 mm ↔5 m  
EAN 4000870 941577  
**941.57** **new**

A++-A

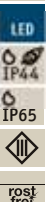



- 🔗 Silber 🗪 Edelstahl/Kunststoff
- 🔗 Argent 🗪 Acier inoxydable/Matière plastique
- 🔗 Zilver 🗪 edelstaal/Kunststof

- ▶ Einfache Montage durch mitgelieferte Einbauhülse
- ▶ Geeignet für Terasse und Erdrich

- ▶ Pose simple par manchon fourni
- ▶ Convient aux terrasses et à la terre

- ▶ Eenvoudige montage door bijgeleverde inbouwhuls
- ▶ Geschikt voor terras en aardrijk

**Plug & Shine Floor Mini**

A++-A

incl. 1x2,5W  
95 lm, 3.000 K  
∠ 95°  
24V  
⇅90 ø55 mm  
EAN 4000870 939512  
**939.51 new**

**Plug & Shine Floor Mini**

A++-A

incl. 1x2,5W  
95 lm, 4.000 K  
∠ 95°  
24V  
⇅90 ø55 mm  
EAN 4000870 939529  
**939.52 new**



- ▶ Starter-Sets für den Einstieg in das System inkl. 3 Leuchten, 5 Meter Kabel mit 4 Ausgängen und einem Trafo für Erweiterungsmöglichkeiten
- ▶ Erweiterbar

- ▶ Kits de démarrage : comprend 3 luminaires, 5m de câble avec 4 sorties et un transformateur pour d'éventuelles extensions
- ▶ Extensible

- ▶ Startersets voor de instap in het systeem incl. 3 lampen, 5 meter kabel met 4 uitgangen en een trafo voor uitbreidingsmogelijkheden
- ▶ Uitbreidbaar

**Plug & Shine Floor Mini Set**

A++-A

incl. 3x2,5W  
3x95 lm, 3.000 K  
∠ 95°  
230/24V, incl. ⚡21 VA  
ø55 mm  
EAN 4000870 936979  
**936.97 new**

**Plug & Shine Floor Mini Set**

A++-A

incl. 3x2,5W  
3x95 lm, 4.000 K  
∠ 95°  
230/24V, incl. ⚡21 VA  
ø55 mm ⇅5 m  
EAN 4000870 936986  
**936.98 new**



- ▶ Erweiterungs-Sets für den einfachen Ausbau des Systems, inkl. 3 Leuchten und 5 Meter Kabel mit 4 Ausgängen

- ▶ Kits d'extension du système : comprend 3 luminaires, 5 m de câble avec 4 sorties

- ▶ Uitbreidingssets voor de eenvoudige uitbreiding van het systeem incl. 3 lampen en 5 meter kabel met 4 uitgangen

**Plug & Shine Floor Mini Extension Set**

A++-A

incl. 3x2,5W  
3x95 lm, 3.000 K  
∠ 95°  
24V  
⇅40 mm ø55 mm ⇅5 m  
EAN 4000870 939499  
**939.49 new**

**Plug & Shine Floor Mini Extension Set**

A++-A

incl. 3x2,5W  
3x95 lm, 4.000 K  
∠ 95°  
24V  
⇅90 mm ø55 mm ⇅5 m  
EAN 4000870 939505  
**939.50 new**





- 🔗 Silber 🗪 Edelstahl/Kunststoff
- 🔗 Argent 🗪 Acier inoxydable/Matière plastique
- 🔗 Zilver 🗪 edelstaal/Kunststof

- ▶ Einfache Montage durch Befestigungsklammern
- ▶ Geeignet für Holz- und Steinterrassen

- ▶ Pose simple par clips de fixation
- ▶ Convient aux terrasses en bois ou en pierre

- ▶ Eenvoudige montage door bevestigingsklemmen
- ▶ Geschikt voor terrassen van hout en steen



**Plug & Shine Floor**

incl. 1x1,3 W  
100 lm, 3.000 K  
↙ 90°  
24 V  
⌀30 ø70 mm  
EAN 4000870 939536  
**939.53 new**



**Plug & Shine Floor**

incl. 1x1,3 W  
100 lm, 4.000 K  
↙ 90°  
24 V  
⌀30 ø70 mm  
EAN 4000870 939543  
**939.54 new**



- ▶ Starter-Sets für den Einstieg in das System inkl. 3 Leuchten, 5 Meter Kabel mit 4 Ausgängen und einem Trafo für Erweiterungsmöglichkeiten
- ▶ Erweiterbar

- ▶ Kits de démarrage : comprend 3 luminaires, 5m de câble avec 4 sorties et un transformateur pour d'éventuelles extensions
- ▶ Extensible

- ▶ Startersets voor de instap in het systeem incl. 3 lampen, 5 meter kabel met 4 uitgangen en een trafo voor uitbreidingsmogelijkheden
- ▶ Uitbreidbaar



**Plug & Shine Floor Set**

incl. 3x1,3 W  
3x100 lm, 3.000 K  
↙ 90°  
24 V, incl. ⚡ 21 VA  
⌀30 mm ø70 mm ↔5 m  
EAN 4000870 936924  
**936.92 new**

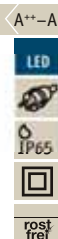

**Plug & Shine Floor Set**

incl. 3x1,3 W  
3x100 lm, 4.000 K  
↙ 90°  
24 V, incl. ⚡ 21 VA  
⌀30 mm ø70 mm ↔5 m  
EAN 4000870 936931  
**936.93 new**





- 🔩 Silber 🏠 Edelstahl
- 🔩 Argent 🏠 Acier inoxydable
- 🔩 Zilver 🏠 edelstaal



- ▶ Starterset incl. 5 Leuchten und Trafo
- ▶ Geeignet für Holz- und Steinterrassen

- ▶ Kit de démarrage inclus 5 luminaires et transfo
- ▶ Convient aux terrasses en bois ou en pierre

- ▶ Starterset incl. 5 armaturen en trafo
- ▶ Geschikt voor terrassen van hout en steen



#### Plug & Shine MicroPen II Set

A++-A

incl. 5x0,22 W  
5x3 lm, 3.000 K  
∠ 22°  
230/24 V, incl. ⚡ 21 VA  
ø15 mm  
EAN 4000870 936955  
**936.95 new**



- ▶ Ergänzungssetset incl. 5 Leuchten
- ▶ Geeignet für Holz- und Steinterrassen

- ▶ Kit d'extension incl. 5 luminaires
- ▶ Convient aux terrasses en bois ou en pierre

- ▶ Uitbreidingsset incl. 5 armaturen
- ▶ Geschikt voor terrassen van hout en steen



#### Plug & Shine MicroPen II Extension Set

A++-A

incl. 5x0,22 W  
5x3 lm, 3.000 K  
∠ 22°  
24 V  
ø15 mm  
EAN 4000870 936948  
**936.94 new**





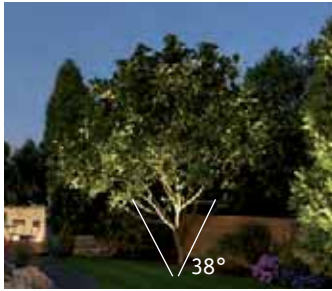

- 🔩 Silber 📦 Metall
- 🔩 Argent 📦 Métal
- 🔩 Zilver 📦 Metaal

- |  |   |  |
|--|---|--|
| <ul style="list-style-type: none"> <li>▶ Ideal für die Ausleuchtung von breiteren Bäumen oder Fassaden</li> <li>▶ Gezielte Ausleuchtung durch definierten Ausstrahlwinkel</li> <li>▶ Perfekte Ausleuchtung, da schwenkbar</li> <li>▶ Entblendet durch versenkte Lichtquelle</li> <li>▶ Ungehindertes Rasenmähen</li> </ul> | <ul style="list-style-type: none"> <li>▶ Convient parfaitement à l'éclairage d'arbres ou de façades</li> <li>▶ Éclairage ciblé grâce à l'angle de rayonnement prédéfini</li> <li>▶ Éclairage parfait car orientable</li> <li>▶ Source lumineuse encastrée non éblouissante</li> <li>▶ Tondre sans obstacle</li> </ul> | <ul style="list-style-type: none"> <li>▶ Ideaal voor het verlichten van bomen of gevels</li> <li>▶ Gerichte verlichting door gedefinieerde uitstraalhoek</li> <li>▶ Perfecte verlichting, aangezien zwenkbaar</li> <li>▶ Niet-verblindend dankzij verzonken lichtbron</li> <li>▶ Ongehinderd grasmaaien</li> </ul> |
|--|---|--|



**Plug & Shine Floor**

incl. 1x6 W  
609 lm, 3.000 K  
∠ 38°  
24 V  
∅150 ∅140 mm  
EAN 4000870 939086  
**939.08 new**



**Plug & Shine Floor**

incl. 1x6 W  
675 lm, 4.000 K  
∠ 38°  
24 V  
∅150 ∅140 mm  
EAN 4000870 939123  
**939.12 new**

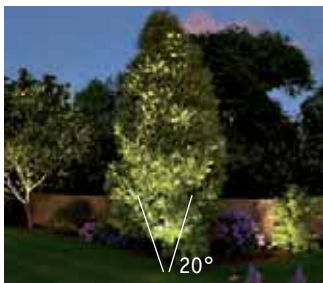

- 🔩 Silber 📦 Metall
- 🔩 Argent 📦 Métal
- 🔩 Zilver 📦 Metaal

- |  |   |   |
|--|---|---|
| <ul style="list-style-type: none"> <li>▶ Ideal für die Ausleuchtung von höheren Bäumen oder Fassaden</li> <li>▶ Gezielte Ausleuchtung durch definierten Ausstrahlwinkel</li> <li>▶ Perfekte Ausleuchtung, da schwenkbar</li> <li>▶ Entblendet durch versenkte Lichtquelle</li> <li>▶ Ungehindertes Rasenmähen</li> </ul> | <ul style="list-style-type: none"> <li>▶ Convient parfaitement à l'éclairage de grands arbres ou de façades</li> <li>▶ Éclairage ciblé grâce à l'angle de rayonnement prédéfini</li> <li>▶ Éclairage parfait car orientable</li> <li>▶ Source lumineuse encastrée non éblouissante</li> <li>▶ Tondre sans obstacle</li> </ul> | <ul style="list-style-type: none"> <li>▶ Ideaal voor het verlichten van hogere bomen of gevels</li> <li>▶ Gerichte verlichting door gedefinieerde uitstraalhoek</li> <li>▶ Perfecte verlichting, aangezien zwenkbaar</li> <li>▶ Niet-verblindend dankzij verzonken lichtbron</li> <li>▶ Ongehinderd grasmaaien</li> </ul> |
|--|---|---|



**Plug & Shine Floor**

incl. 1x6 W  
609 lm, 3.000 K  
∠ 20°  
24 V  
∅150 ∅140 mm  
EAN 4000870 939079  
**939.07 new**



**Plug & Shine Floor**

incl. 1x6 W  
675 lm, 4.000 K  
∠ 20°  
24 V  
∅150 ∅140 mm  
EAN 4000870 939116  
**939.11 new**

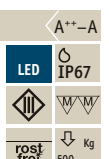



- 🔗 Anthrazit Alu Druckguss
- 🔗 Anthracite Alu moulé sous pression
- 🔗 Antraciet Alu drukgegoten

- ▶ Ideal für gleichmäßig breite lichtstarke Beleuchtung von Mauern, Hecken, Hauswänden und zur effektvollen Hervorhebung von Reliefs
- ▶ Entblendet durch versenkte Lichtquelle
- ▶ Ungehindertes Rasenmähen
- ▶ Convient parfaitement à l'éclairage puissant, large et homogène de murs, haies et façades ou pour la mise en évidence efficace des reliefs
- ▶ Source lumineuse encastrée non éblouissante
- ▶ Tondre sans obstacle
- ▶ Ideaal voor een gelijkmatig brede, lichtsterke verlichting van muren, hagen, gevels en voor een effectieve accentueren van reliëfs
- ▶ Niet-verblindend dankzij verzonken lichtbron
- ▶ Ongehinderd grasmaaien

**Plug & Shine Floor**

A++-A

incl. 1x8 W

875 lm, 3.000 K

✗ 95°

24 V

⏏ 45 ⏏ 900 ⏏ 54 mm

EAN 4000870 939215

**939.21 new**

LED

IP67



- 🔗 Anthrazit Alu Druckguss
- 🔗 Anthracite Alu moulé sous pression
- 🔗 Antraciet Alu drukgegoten

- ▶ Ideal für gleichmäßig breite lichtstarke Beleuchtung von Mauern, Hecken, Hauswänden und zur effektvollen Hervorhebung von Reliefs
- ▶ Schwenkbar
- ▶ Rahmenlos verkettbar für gleichmäßige Ausleuchtung langer Flächen
- ▶ Convient parfaitement à l'éclairage puissant, large et homogène de murs, haies et façades ou pour la mise en évidence efficace des reliefs
- ▶ Orientable
- ▶ Combinable librement pour l'éclairage homogène de longues surfaces
- ▶ Ideaal voor een gelijkmatig brede, lichtsterke verlichting van muren, hagen, gevels en voor een effectieve accentueren van reliëfs
- ▶ Zwenkbaar
- ▶ Zonder frame verbindbaar voor gelijkmatige verlichting van lange oppervlakken

**Plug & Shine Floor**

A++-A

incl. 1x8 W

875 lm, 3.000 K

✗ 115°

24 V

⏏ 58 ⏏ 856 ⏏ 52 mm

EAN 4000870 939222

**939.22 new**

LED

IP67





- 🔗 Silber/Anthrazit 🏠 Alu Druckguss
- 🔗 Argent/Anthracite
- 🏠 Alu moulé sous pression
- 🔗 Zilver/Antraciet 🏠 Alu drukgegoten

- |  |  |   |
|--|--|---|
| <ul style="list-style-type: none"> <li>▶ Mit Abstrahlwinkel 60° zur Ausleuchtung schmalere Wege</li> <li>▶ Gerichtetes Licht ohne Blendwirkung</li> <li>▶ Mit Montageplatte auf festem Untergrund verschraubbar</li> <li>▶ Mit mitgeliefertem Spieß einfach in weichem Untergrund fixierbar</li> </ul> | <ul style="list-style-type: none"> <li>▶ Avec angle de rayonnement de 60° pour l'éclairage d'allées étroites</li> <li>▶ Éclairage dirigé non aveuglant</li> <li>▶ Vissage sur support stabilisé grâce à la platine de fixation</li> <li>▶ Peut être facilement fixé dans un sol meuble grâce au piquet fourni</li> </ul> | <ul style="list-style-type: none"> <li>▶ Met stralingshoek 60° voor de verlichting van smalle paden</li> <li>▶ Gericht licht niet verblindend</li> <li>▶ Met montageplaat op vaste ondergrond vastschroefbaar</li> <li>▶ Met bijgeleverde pen gewoon in zachte ondergrond fixeerbaar</li> </ul> |
|--|--|---|



**Plug & Shine Cone**

A++-A

incl. 1x4,3 W  
 438 lm, 3.000 K  
 <math>\sphericalangle</math> 60°  
 24 V  
 ⚙️592 ⌀60 ↔110 ↻212 mm  
 EAN 4000870 939130  
**939.13 new**



**Plug & Shine Cone**

A++-A

incl. 1x4,3 W  
 438 lm, 3.000 K  
 <math>\sphericalangle</math> 90°  
 24 V  
 ⚙️592 ⌀90 ↔110 ↻212 mm  
 EAN 4000870 939147  
**939.14 new**



- 🔗 Silber/Anthrazit 🏠 Alu Druckguss
- 🔗 Argent/Anthracite
- 🏠 Alu moulé sous pression
- 🔗 Zilver/Antraciet 🏠 Alu drukgegoten

- |   |   |  |
|---|---|--|
| <ul style="list-style-type: none"> <li>▶ 360° rundum abstrahlend zur Ausleuchtung von Wegen und Beeten</li> <li>▶ Gerichtetes Licht ohne Blendwirkung</li> <li>▶ Mit Montageplatte auf festem Untergrund verschraubbar</li> <li>▶ Mit mitgeliefertem Spieß einfach in weichem Untergrund fixierbar</li> </ul> | <ul style="list-style-type: none"> <li>▶ Angle de rayonnement de 360° pour l'éclairage d'allées et de massifs</li> <li>▶ Éclairage dirigé non aveuglant</li> <li>▶ Vissage sur support stabilisé grâce à la platine de fixation</li> <li>▶ Peut être facilement fixé dans un sol meuble grâce au piquet fourni</li> </ul> | <ul style="list-style-type: none"> <li>▶ 360° rondom uitstralend voor de verlichting van paden en perken</li> <li>▶ Gericht licht niet verblindend</li> <li>▶ Met montageplaat op vaste ondergrond vastschroefbaar</li> <li>▶ Met bijgeleverde pen gewoon in zachte ondergrond fixeerbaar</li> </ul> |
|---|---|--|



**Plug & Shine Cone**

A++-A

incl. 1x8,2 W  
 776 lm, 3.000 K  
 24 V  
 ⚙️856 ⌀110 mm  
 EAN 4000870 939154  
**939.15 new**





- 🔗 Anthrazit Alu Druckguss
- 🔗 Anthracite Alu moulé sous pression
- 🔗 Antraciet Alu drukgegoten

- ▶ Ideal zur Beleuchtung der Einfahrt
- ▶ Blendfrei durch effektvolles Streiflicht
- ▶ Extra schwere Qualität
- ▶ Befahrbar

- ▶ Idéal pour l'éclairage d'entrées
- ▶ Non éblouissant grâce à un bandeau lumineux raffiné
- ▶ Qualité extra robuste
- ▶ Carrossable

- ▶ Ideaal voor de verlichting van de inrit
- ▶ Niet-verblindend door effectvol scheerlicht
- ▶ Extra zware kwaliteit
- ▶ Overrijdbaar



**Plug & Shine Floor**

A++-A

incl. 1x3 W  
 350 lm, 3.000 K  
 ✂ 60°  
 24 V  
 ⚙ 32 ø160 mm  
 EAN 4000870 939192  
**939.19 new**



**Plug & Shine Floor**

A++-A

incl. 2x3 W  
 2x350 lm, 3.000 K  
 ✂ 180°  
 24 V  
 ⚙ 32 ø160 mm  
 EAN 4000870 939208  
**939.20 new**



- 🔗 Anthrazit Alu Druckguss
- 🔗 Anthracite Alu moulé sous pression
- 🔗 Antraciet Alu drukgegoten

- ▶ Ideal für die Wegebeleuchtung ohne Blendung

- ▶ Convient parfaitement à l'éclairage non aveuglant d'allées

- ▶ Ideaal voor de padverlichting zonder te verblinden



**Plug & Shine Path**

A++-A

incl. 1x3 W  
 350 lm, 3.000 K  
 ✂ 60°  
 24 V  
 ⚙ 155 ø193 mm  
 EAN 4000870 939161  
**939.16 new**



**Plug & Shine Path**

A++-A

incl. 2x3 W  
 2x350 lm, 3.000 K  
 ✂ 180°  
 24 V  
 ⚙ 155 ø193 mm  
 EAN 4000870 939178  
**939.17 new**





▶ Lichtobjekte für die stimmungsvolle Beleuchtung von Garten und Terasse

▶ Objets lumineux pour l'éclairage agréable du jardin et de la terrasse

▶ Lichtobjecten voor de sfeervolle verlichting van tuin en terras



- 🔗 Weiß 📦 Kunststoff
- 🔗 Blanc
- 📦 Matière plastique
- 🔗 Wit 📦 Kunststof

**Plug & Shine Stone**

A++-A

incl. 1x2,8W  
235 lm, 3.000 K  
24 V  
⌀166 ⌀280 mm  
EAN 4000870 941751  
**941.75 new**



**Plug & Shine Stone**

A++-A

incl. 1x2,8W  
235 lm, 3.000 K  
24 V  
⌀194 ⌀350 mm  
EAN 4000870 941768  
**941.76 new**



**Plug & Shine Globe**

A++-A

incl. 1x2,8W  
235 lm, 3.000 K  
24 V  
⌀200 mm  
EAN 4000870 941775  
**941.77 new**



**Plug & Shine Globe**

A++-A

incl. 1x6,5W  
575 lm, 3.000 K  
24 V  
⌀400 mm  
EAN 4000870 941782  
**941.78 new**



**Plug & Shine Globe**

A++-A

incl. 1x6,5W  
575 lm, 3.000 K  
24 V  
⌀500 mm  
EAN 4000870 941799  
**941.79 new**



**Plug & Shine Cube**

A++-A

incl. 1x2,8W  
235 lm, 3.000 K  
24 V  
⌀200 ⇄200 ↗200 mm  
EAN 4000870 941805  
**941.80 new**



**Plug & Shine Cube**

A++-A

incl. 1x6,5W  
575 lm, 3.000 K  
24 V  
⌀300 ⇄300 ↗300 mm  
EAN 4000870 941812  
**941.81 new**



**Plug & Shine Cube**

A++-A

incl. 1x6,5W  
575 lm, 3.000 K  
24 V  
⌀400 ⇄400 ↗400 mm  
EAN 4000870 941829  
**941.82 new**





### Plug & Shine Plant

A++-A

incl. 1x6,5 W  
575 lm, 3.000 K  
24 V  
↕500 ↔300 ↗230 mm  
EAN 4000870 941836

**941.83 new**

- 👉 Weiß 📦 Kunststoff
- 👉 Blanc 📦 Matière plastique
- 👉 Wit 📦 Kunststof



### Plug & Shine Star

A++-A

incl. 1x2,8 W  
235 lm, 3.000 K  
24 V  
↕100 ⌀400 mm  
EAN 4000870 941853

**941.84 new**

- 👉 Weiß 📦 Kunststoff
- 👉 Blanc 📦 Matière plastique
- 👉 Wit 📦 Kunststof



### Plug & Shine Tree

A++-A

incl. 1x2,8 W  
260 lm, 3.000 K  
24 V  
↕490 ↔280 ↗140 mm  
EAN 4000870 941850

**941.85 new**

- 👉 Weiß 📦 Kunststoff
- 👉 Blanc 📦 Matière plastique
- 👉 Wit 📦 Kunststof



### Plug & Shine Lightchain IP44

A++-A

incl. 7x0,2 W  
7x25 lm  
24 V  
⌀50 mm ↔6,8 m  
EAN 4000870 941652

**941.65 new**

- 👉 Weiß 📦 Kunststoff
- 👉 Blanc 📦 Matière plastique
- 👉 Wit 📦 Kunststof





- ▶ Mehrfach gesicherte, UV-beständige Gummischlauchleitung
- ▶ Für hohe mechanische Belastung für die dauerhafte Verwendung im Freien
- ▶ Speziell entwickelte mehrfach gedichtete Paulmann-Steckverbindungen
- ▶ Dauerhaft wasserdicht (IP 68)

- ▶ Gaine en caoutchouc résistante aux UV, et plusieurs fois sécurisée.
- ▶ Pour une forte sollicitation mécanique et l'utilisation continue à l'air libre
- ▶ Connexions Paulmann spécialement conçues à multiples niveaux d'étanchéité
- ▶ Étanches durablement (IP 68)

- ▶ Extra beveiligde, UV-bestendige rubberslangleiding
- ▶ Voor hoge mechanische belasting voor duurzaam gebruik buitenshuis
- ▶ Speciaal ontwikkelde maximaal geïsoleerde Paulmann-steekverbindingen
- ▶ Duurzaam waterdicht (IP 68)



- 👉 Schwarz
- 📦 Kunststoff
- 👉 Noir
- 📦 Matière plastique
- 👉 Zwart
- 📦 Kunststof



**Plug & Shine Connector 1in-3out**

max. 150 W  
24 V  
↔75 ↔94 mm  
EAN 4000870 939291  
**939.29 new**



**Plug & Shine Cable 1in-2out**

max. 150 W  
24 V  
↔2 m  
EAN 4000870 939260  
**939.26 new**



**Plug & Shine Cable 1in-3out**

max. 150 W  
24 V  
↔1 m  
EAN 4000870 939949  
**939.94 new**



**Plug & Shine Cable 1in-2out**

max. 150 W  
24 V  
↔5 m  
EAN 4000870 939277  
**939.27 new**



**Plug & Shine Cable 1in-5out**

max. 150 W  
24 V  
↔10 m  
EAN 4000870 939307  
**939.30 new**



**Plug & Shine Cable 1in-2out**

max. 150 W  
24 V  
↔10 m  
EAN 4000870 939284  
**939.28 new**



**Plug & Shine Cable 1in-7out**

max. 150 W  
24 V  
↔15 m  
EAN 4000870 939314  
**939.31 new**



- ▶ System oder Komponentensteuerung 24V DC max. 75W
- ▶ Gruppenschaltung oder Schaltung mehrerer Controller mit einer Fernbedienung möglich

- ▶ Contrôle du système ou des composants 24 V DC max. 75 W
- ▶ La commutation groupée ou la commutation de plusieurs controllers est possible avec une seule télécommande.

- ▶ Systeem- of componentenbesturing 24 V DC max. 75 W
- ▶ Groepsschakeling of schakeling van meerdere controllers mogelijk met één afstandsbediening



**Plug & Shine Controller incl. remote**

max. 75 W 24 V  
AAA/1,5V (Micro) × 2  
↔90 ↔260 ↗40 mm  
EAN 4000870 180112  
**180.11 new**



**Plug & Shine Controller**

max. 75 W  
24 V  
↔90 ↔260 ↗40 mm  
EAN 4000870 180105  
**180.10 new**





- ▶ Zigbee 3.0 Schalt und Dimm-Controller für das 12-24V DC Gartenleuchten-System Plug & Shine
- ▶ Einfache und sichere Installation mit Plug & Shine Verbinder
- ▶ Für alle dimmbaren Plug & Shine Leuchten geeignet
- ▶ Gruppenschaltung oder Schaltung mehrerer Controller mit einer Fernbedienung möglich
- ▶ Controller commutation et variation Zigbee 3.0 pour système de luminaires de jardin Plug & Shine 12-24V DC
- ▶ Installation sûre et simple grâce au connecteur Plug & Shine
- ▶ Convient à tous les luminaires Plug & Shine grad
- ▶ La commutation groupée ou la commutation de plusieurs controllers est possible avec une seule télécommande.
- ▶ Zigbee 3.0 schakel- en dimcontroller voor het 12-24V DC tuinverlichtingssysteem Plug & Shine
- ▶ Eenvoudige en veilige installatie met Plug & Shine connector
- ▶ Geschikt voor alle dimbare Plug & Shine armaturen
- ▶ Groepsschakeling of schakeling van meerdere controllers mogelijk met één afstandsbediening



not incl.  
Remote Control  
= 402  
**ZigBee**

**Plug & Shine ZigBee Controller**

max. 75 W  
24 V  
⌀30 ⇄260 ⌀40 mm  
EAN 4000870 939994  
**939.99 new**



- ▶ Steckerdriver IP44 ideal für die Beleuchtung von Balkon und des Terrassenbereichen
- ▶ Driver de fiche IP44 idéal pour l'éclairage des balcons et terrasses
- ▶ Stekkerdriver IP44 ideaal voor de verlichting van balkon en terras

**Power Supply 21W IP44  
230/24V DC**

max. 21 W  
230/24 V, incl. ⇄21 VA  
⌀104 ⇄50 ⌀30 mm  
EAN 4000870 988480  
**988.48 new**

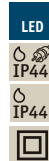
**Power Supply 75W IP44  
230/24V DC**

max. 75 W  
230/24 V, incl. ⇄75 VA  
⌀40 ⇄186 ⌀64 mm  
EAN 4000870 988497  
**988.49 new**

**Power Supply 150W IP44  
230/24V DC**

max. 150 W  
230/24 V, incl. ⇄150 VA  
⌀40 ⇄223 ⌀70 mm  
EAN 4000870 988503  
**988.50 new**

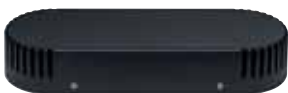

- ▶ Formschöne Trafo-Montage-Box für eine stimmige Integration eines Trafos an der Hauswand
- ▶ Élégant boîtier de pose de transformateur pour intégrer celui-ci de façon harmonieuse contre le mur.
- ▶ Trafomontagebox met mooie vorm voor een passende integratie van een trafo aan de huiswand

**Trafo-Box**

⌀45 ⇄260 ⌀89 mm  
EAN 4000870 939048  
**939.04 new**







## Mobile

### Mobile: die praktischen Akku-Leuchten zum Mitnehmen

Absolut tragbar! Paulmann Mobile ist ein einzigartiges Sortiment an mobilen Außenleuchten für angenehmes Licht überall. Die Mobile Steh- und Tischleuchten mit integriertem Akku einfach in den Garten oder auf die Terrasse stellen und gemütliches Licht genießen! Die Leuchten sind vor Wasser geschützt, meist dimmbar und bequem über das mitgelieferte USB-Kabel an allen gängigen Ladegeräten aufzuladen. Aufladen, einpacken, mitnehmen und an jedem Ort mit stimmungsvollem Licht beeindrucken.

### Mobile : les luminaires mobiles à batteries prêts à l'emploi

Mobilité absolue ! Les luminaires mobiles Paulmann sont une gamme unique de luminaires d'extérieur mobiles pour un éclairage agréable à tout moment. Lampadaires et lampes à poser Mobile avec batterie intégrée, à poser tout simplement dans le jardin ou la terrasse ; il n'y a plus qu'à savourer le plaisir de la lumière ! Les luminaires sont protégés contre l'eau, gradables pour la plupart et faciles à charger via le cordon USB fourni sur tous les chargeurs conventionnels. Recharger, emballer, transporter et conférer à chaque endroit un éclairage agréable.

### Mobile: de praktische accu-armaturen om mee te nemen

Absoluut draagbaar! Paulmann Mobile is een uniek assortiment van mobiele buitenarmaturen voor aangenaam licht overal. De Mobile staande en tafellampen met geïntegreerde accu gewoon in de tuin of op het terras plaatsen en van het gezellige licht genieten! De armaturen zijn tegen water beschermd, meestal dimbaar en eenvoudig via de bijgeleverde USB-kabel aan alle in de handel verkrijgbare accoladers te laden. Laden, inpakken, meenemen en op iedere plek indruk maken met gezellig licht.



- ▶ Erstes mobiles Licht-System: LED-Einheit mit integriertem Akku
- ▶ Aus der Basis Tisch- und Bodenleuchte wird mit Zubehör im Handumdrehen eine Steh-, Hänge- oder Wandleuchte
- ▶ Clipsaufnahme für diverse Schirme eröffnet individuelle Gestaltungsmöglichkeiten
- ▶ Premier système de lampe mobile : Unité à LED avec batterie intégrée
- ▶ Grâce à des accessoires, lampes à poser et lampes de sol se transforment en un tournemain en lampadaires, suspensions ou appliques
- ▶ L'encoche de clips pour divers abat-jours offre des possibilités d'aménagement personnalisées
- ▶ Eerste mobiele lichtstelsel: LED-eenheid met geïntegreerde accu
- ▶ Uit de basis tafel- en vloerlamp wordt met toebehoren in een handomdraai een staande, hangende of wandlamp
- ▶ Clipbevestiging voor diverse lampenkappen biedt individuele vormgevingsmogelijkheden

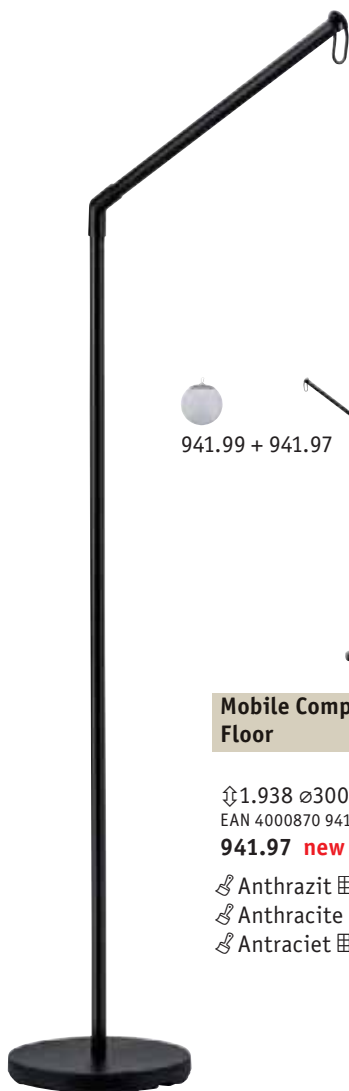

941.99 + 941.97

### Mobile Companion Accessory Floor

∩1.938 ∅300 mm  
EAN 4000870 941973

**941.97 new**

- ∩ Anthrazit ∩ Kunststoff
- ∩ Anthracite ∩ Matière plastique
- ∩ Antraciet ∩ Kunststof



### Mobile Companion

incl. 1x1,5 W  
120 lm, 3.000 K  
18650 Akku/3,7V x 1  
DC 5 V  
∩221 ∅230 mm  
EAN 4000870 941997

**941.99 new**

- ∩ Weiß ∩ Kunststoff
- ∩ Blanc ∩ Matière plastique
- ∩ Wit ∩ Kunststof

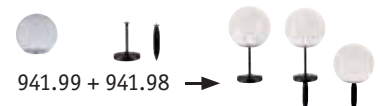

941.99 + 941.98

### Mobile Companion Accessory Table

∩385 ∅140 mm  
EAN 4000870 941980

**941.98 new**

- ∩ Anthrazit ∩ Kunststoff
- ∩ Anthracite ∩ Matière plastique
- ∩ Antraciet ∩ Kunststof



- ▶ Mini USB Anschluss und Kabel zum Laden des Akkus oder zum Betrieb der Leuchte bei leerem Akku mit einem externen Netzteil oder einer Powerbank
- ▶ Avec mini port USB et câble de recharge de batterie ou pour fonctionnement du luminaire sur bloc d'alimentation externe ou station de recharge, en cas de batterie vide
- ▶ Mini USB-aansluiting en kabel voor het opladen van de accu of voor gebruik van de armatuur bij lege accu met een extern netdeel of een powerbank.



#### Mobile Tripod

incl. 1x2 W  
180 lm, 3.000 K  
18650 Akku/3,7V x 1  
DC 5 V  
∅1.600 ∅410 mm  
EAN 4000870 941720  
**941.72 new**



- ↳ Weiß/Grau ▣ Metall/Kunststoff
- ↳ Blanc/Gris ▣ Métal/Matière plastique
- ↳ Wit/Grijs ▣ Metaal/Kunststof



#### Mobile Tripod

incl. 1x2 W  
180 lm, 3.000 K  
18650 Akku/3,7V x 1  
DC 5 V  
∅550 ∅400 mm  
EAN 4000870 941737  
**941.73 new**





- ▶ Mini USB Anschluss und Kabel zum Laden des Akkus oder zum Betrieb der Leuchte bei leerem Akku mit einem externen Netzteil oder einer Powerbank
- ▶ Avec mini port USB et câble de recharge de batterie ou pour fonctionnement du luminaire sur bloc d'alimentation externe ou station de recharge, en cas de batterie vide
- ▶ Mini USB-aansluiting en kabel voor het opladen van de accu of voor gebruik van de armatuur bij lege accu met een extern netdeel of een powerbank.

**Mobile Placido**

incl. 1x2 W  
180 lm, 3.000 K  
18650 Akku/3,7V x 1  
DC 5 V  
∅1.500 ∅311 mm  
EAN 4000870 941706  
**941.70 new**

A++-A



Wei/Grau Metall/Kunststoff  
Blanc/Gris Mtal/Matire plastique  
Wit/Grijs Metaal/Kunststof

**Mobile Placido**

incl. 1x1 W  
90 lm, 3.000 K  
18650 Akku/3,7V x 1  
DC 5 V  
∅260 ∅160 mm  
EAN 4000870 941744  
**941.74 new**

A++-A





- ▶ Mini USB Anschluss und Kabel zum Laden des Akkus oder zum Betrieb der Leuchte bei leerem Akku mit einem externen Netzteil oder einer Powerbank
- ▶ Avec mini port USB et câble de recharge de batterie ou pour fonctionnement du luminaire sur bloc d'alimentation externe ou station de recharge, en cas de batterie vide
- ▶ Mini USB-aansluiting en kabel voor het opladen van de accu of voor gebruik van de armatuur bij lege accu met een extern netdeel of een powerbank.

- ↳ Anthrazit ■■ Kunststoff
- ↳ Anthracite ■■ Matière plastique
- ↳ Antraciet ■■ Kunststof



**Mobile Portino**

incl. 1x3,5 W  
 390 lm, 3.000 K  
 ∠ 100°  
 18650 Akku/3,7V x 2  
 DC 5 V  
 ∅340 ∅300 mm  
 EAN 4000870 942062  
**942.06 new**



**Mobile Moval**

incl. 1x3,5 W  
 370 lm, 3.000 K  
 ∠ 100°  
 18650 Akku/3,7V x 2  
 DC 5 V  
 ∅55 ∅350 ∅130 mm  
 EAN 4000870 942079  
**942.07 new**





Play music over your Smartphone



- 🔊 Grau 📦 Kunststoff
- 🔊 Gris 📦 Matière plastique
- 🔊 Grijs 📦 Kunststof

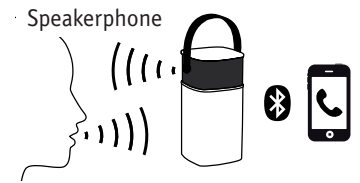

- ▶ Ladbar über USB
- ▶ Mit integrierter Powerbank, Musikwiedergabe über Bluetooth oder Kabelanschluss

- ▶ Rechargeable par USB
- ▶ Avec Powerbank intégré, reproduction musicale via Bluetooth ou raccordement par câble

- ▶ Laadbaar via USB
- ▶ Met geïntegreerde powerbank, muziekweergave via Bluetooth of kabelaansluiting



**Mobile Accu Tablelamp Clutch Sound Power**

incl. 1x1,3W  
 67 lm, 3.000 K  
 18650 Akku/3,7V x 2  
 DC 5V  
 ⚙️ 150 ↔ 95 ↗ 95 mm  
 EAN 4000870 942116  
**942.11** 📦 **new**

- LED
- incl.
- IP44
- rost frei
- incl. Accu
- Bluetooth
- On/Off



Play music over your Smartphone



- 🔊 Grau 📦 Kunststoff
- 🔊 Gris 📦 Matière plastique
- 🔊 Grijs 📦 Kunststof

- ▶ Ladbar über USB mit externem Netzteil oder Powerbank (nicht im Lieferumfang)

- ▶ Rechargeable par USB à l'aide de l'alimentation externe ou de la station de recharge (non fournie)

- ▶ Opladbaar via USB met extern netdeel of powerbank (niet in de levering begrepen)



**Mobile Accu Tablelamp Clutch Sound**

incl. 1x1,5W  
 60 lm, 3.000 K  
 18650 Akku/3,7V x 1  
 DC 5V  
 ⚙️ 190 ø77 mm  
 EAN 4000870 942123  
**942.12** 📦 **new**

- LED
- incl.
- IP44
- rost frei
- incl. Accu
- Bluetooth
- On/Off



- 👉 Grau 📦 Kunststoff
- 👉 Gris 📦 Matière plastique
- 👉 Grijs 📦 Kunststof

▶ Ladbar über USB mit externem Netzteil oder Powerbank (nicht im Lieferumfang)

▶ Rechargeable par USB à l'aide de l'alimentation externe ou de la station de recharge (non fournie)

▶ Opladbaar via USB met extern netdeel of powerbank (niet in de levering begrepen)



#### Mobile Accu Tablelamp Clutch

incl. 1x1,6W  
172 lm, 3.000 K  
18650 Akku/3,7V x 1  
DC 5V  
⌈120 ø85 mm  
EAN 4000870 942109

**942.10** 📦 **new**



- 👉 Grau 📦 Kunststoff
- 👉 Gris 📦 Matière plastique
- 👉 Grijs 📦 Kunststof

▶ Minitaschenlampe incl.  
▶ Ladbar über USB

▶ Mini lampe de poche incl.  
▶ Rechargeable par USB

▶ Minizaklamp incl.  
▶ Laadbaar via USB



#### Mobile Kit IP44

incl. 1x0,3W  
18 lm, 3.000 K  
fest verbauter Akku  
DC 5V  
⌈199 ø173 mm  
EAN 4000870 942048

**942.04** **new**





- 🔗 Grau 📦 Kunststoff
- 🔗 Gris 📦 Matière plastique
- 🔗 Grijs 📦 Kunststof

- ▶ Minitaschenlampe incl.
- ▶ Ladbar über USB

- ▶ Mini lampe de poche incl.
- ▶ Rechargeable par USB

- ▶ Minizaklamp incl.
- ▶ Laadbaar via USB



### Mobile Kit Globe IP44

incl. 1x0,3 W  
 18 lm, 3.000 K  
 fest verbauter Akku  
 DC 5 V  
 ⚙️189 ø224 mm  
 EAN 4000870 942055  
**942.05 new**

- LED
- IP44
- 🔗
- rostfrei
- 📦 incl. Akku
- 🔌 On/Off



- 🔗 Weiß 📦 Kunststoff
- 🔗 Blanc 📦 Matière plastique
- 🔗 Wit 📦 Kunststof

- ▶ LED Strip für den Betrieb an USB Powerbank (nicht im Lieferumfang)
- ▶ Inkl. Lichtsack, Silikonhalter und Haltemagnete
- ▶ Durchscheinender Nylonsack für diffuse Lichtwirkung und Anwendung als Hängeleuchte

- ▶ Strip LED pour fonctionnemt sur station rech USB (non fournie)
- ▶ Avec sac lumière, support silicone et aimant de fixation
- ▶ Sac en nylon translucide pour un effet lumineux diffus en suspension

- ▶ LED Strip voor gebruik aan de USB powerbank (niet bijgeleverd)
- ▶ Incl. Lichtzak, silicon houder en houdmagneten
- ▶ Doorschijnende nylon zak voor een diffuus lichteffect en gebruik als hanglamp



### Mobile Stripe Amigo

incl. 1x5 W  
 400 lm, 3.000 K  
 DC 5 V  
 ⚙️200 mm ø150 mm ⇄12,7 mm ↗4,2 mm  
 ⇄2 m  
 EAN 4000870 941959  
**941.95 new**

- A++-A
- LED
- 🔗

### Mobile Stripe Amigo

incl. 1x7 W  
 600 lm, 3.000 K  
 DC 5 V  
 ⚙️200 mm ø150 mm ⇄12,7 mm ↗4,2 mm  
 ⇄3 m  
 EAN 4000870 941966  
**941.96 new**

- A++-A
- LED
- 🔗





- 👉 Weiß 📦 Kunststoff
- 👉 Blanc 📦 Matière plastique
- 👉 Wit 📦 Kunststof

▶ Mini USB Anschluss und Kabel zum Laden des Akkus oder zum Betrieb der Leuchte bei leerem Akku mit einem externen Netzteil oder einer Powerbank

▶ Avec mini port USB et câble de recharge de batterie ou pour fonctionnement du luminaire sur bloc d'alimentation externe ou station de recharge, en cas de batterie vide

▶ Mini USB-aansluiting en kabel voor het opladen van de accu of voor gebruik van de armatuur bij lege accu met een extern netdeel of een powerbank.



#### Mobile Lampion Chain

incl. 7×0,02 W  
7×1 lm, 3.000 K  
18650 Akku/3,7V × 1  
DC 5 V  
ø73 mm ⇔ 3,6 m  
EAN 4000870 941669  
**941.66** 📦 **new**

A++-A

LED

IP44

Incl.

Accu

On/Off



- 👉 Weiß 📦 Kunststoff
- 👉 Blanc 📦 Matière plastique
- 👉 Wit 📦 Kunststof

▶ Mini USB Anschluss und Kabel zum Laden des Akkus oder zum Betrieb der Leuchte bei leerem Akku mit einem externen Netzteil oder einer Powerbank

▶ Avec mini port USB et câble de recharge de batterie ou pour fonctionnement du luminaire sur bloc d'alimentation externe ou station de recharge, en cas de batterie vide

▶ Mini USB-aansluiting en kabel voor het opladen van de accu of voor gebruik van de armatuur bij lege accu met een extern netdeel of een powerbank.



#### Mobile Light Chain

incl. 48×0,02 W  
48×1 lm, 3.000 K  
18650 Akku/3,7V × 1  
DC 5 V  
ø6 mm ⇔ 6,8 m  
EAN 4000870 941676  
**941.67** 📦 **new**

A++-A

LED

IP44

Incl.

Accu

On/Off



- 🔗 Weiß/Grau 📦 Kunststoff
- 🔗 Blanc/Gris 📦 Matière plastique
- 🔗 Wit/Grijs 📦 Kunststof

- ▶ Mini USB Anschluss und Kabel zum Laden des Akkus oder zum Betrieb der Leuchte bei leerem Akku mit einem externen Netzteil oder einer Powerbank
- ▶ Avec mini port USB et câble de recharge de batterie ou pour fonctionnement du luminaire sur bloc d'alimentation externe ou station de recharge, en cas de batterie vide
- ▶ Mini USB-aansluiting en kabel voor het opladen van de accu of voor gebruik van de armatuur bij lege accu met een extern netdeel of een powerbank.

**Mobile Lampion**

A++-A

incl. 1x0,2W  
 16lm, 3.000 K  
 14500 Akku/ 3,7V  
 DC 5V  
 ⌀170 ø140 mm  
 EAN 4000870 941690  
**941.69** 📦 **new**



- 🔗 Schwarz 📦 Kunststoff
- 🔗 Noir 📦 Matière plastique
- 🔗 Zwart 📦 Kunststof

- ▶ LED Strip für Sonnenschirmbeleuchtung
- ▶ Betrieb mit Powerbank (nicht im Lieferumfang enthalten)
- ▶ Für indirektes Licht am Sitzplatz im Garten oder auf der Terrasse
- ▶ Strip LED pour parasols
- ▶ Fonctionnement sur station de recharge (non fournie)
- ▶ Pour une lumière indirecte quand on est assis dans le jardin ou sur la terrasse
- ▶ LED Strip voor parasolverlichting
- ▶ Gebruik met powerbank (niet in de levering begrepen)
- ▶ Voor indirect licht bij het zitje in de tuin of op het terras

**Mobile Parasol Light**

A++-A

incl. 4x0,45 W  
 4x30 lm, 3.000 K  
 DC 5V  
 ⌀3 mm ⇔400 mm ↻5 mm ⇔0,4 m  
 EAN 4000870 942086  
**942.08** 📦 **new**



- Alu ■ ■ ■ Kunststoff
- Alu ■ ■ ■ Matière plastique
- Alu ■ ■ ■ Kunststof



LED □ □ = 415-450

► Die zuverlässigen 230V Leuchten für Licht rund ums Haus

► Les luminaires 230 V fiables pour un éclairage tout autour de la maison

► De betrouwbare 230V armaturen voor licht rondom het huis



#### Tube

max. 15 W, E27  
230 V  
∅200 ⇔120 ⇔175 mm  
EAN 4000870 941867  
**941.86 new**

A++-E

IP54

rost  
frei

☒



- Grau ■ ■ ■ Kunststoff
- Gris ■ ■ ■ Matière plastique
- Grijs ■ ■ ■ Kunststof



#### Wall Luminaire

incl. 1×8 W  
800 lm, 3.000 K  
230 V  
∅140 ø58 mm  
EAN 4000870 941195  
**941.19 new**

A++-A

LED

IP54

☒

rost  
frei



#### Wall Luminaire

incl. 1×15 W  
1.500 lm, 3.000 K  
230 V  
∅180 ø66 mm  
EAN 4000870 941881  
**941.88 new**

A++-A

LED

IP54

☒

rost  
frei

- 🔗 Grau 🏠 Kunststoff
- 🔗 Gris 🏠 Matière plastique
- 🔗 Grijs 🏠 Kunststof



**Sensor**  
 90°  
 4-7m  
 On < 20Lux  
 Off > 20Lux  
 Time ON < 30 sec



**Wall**

incl. 1x15 W  
 1.500 lm, 3.000 K  
 230 V  
 ⚙️ 180 ø66 mm  
 EAN 4000870 941874  
**941.87 new**

A++-A

LED

Sensor

IP54

rost frei



- 🔗 Edelstahl/Weiß 🏠 Edelstahl/Polycarbonat
- 🔗 Acier inoxydable/Blanc
- 🏠 Acier inoxydable/Polycarbonate
- 🔗 Edelstaal/Wit 🏠 edelstaal/Polycarbonaat



- ▶ Mit Dämmerungsschalter
- ▶ Inkl. Hausnummern in Edelstahloptik
- ▶ Hausnummerngröße 10cm, entsprechend offizieller Vorgaben
- ▶ Betrieb direkt mit 230 V

- ▶ Équipé d'un commutateur crépusculaire
- ▶ Comprend un éclairage de numéro de maison effet acier inoxydable
- ▶ Numéro de maison d'une taille de 10 cm, conformément aux prescriptions officielles
- ▶ Fonctionnement direct avec 230 V

- ▶ Met schemerschakelaar
- ▶ Incl. huisnummers in edelstaaloptiek
- ▶ Huisnummergrootte 10cm, conform officiële specificaties
- ▶ Rechtstreeks bedrijf met 230 V



**House Number Sunset**

incl. 1x5,6 W  
 160 lm, 2.700 K  
 230 V  
 ø260 ⚙️55 mm  
 EAN 4000870 937914  
**937.91**

A++-A

LED

IP44

Stainless Steel  
rost frei

Silber/Anthrazit 田 Alu/Acryl  
 Argent/Anthracite 田 Alu/Acryl  
 Zilver/Antraciet 田 Alu/Acryl

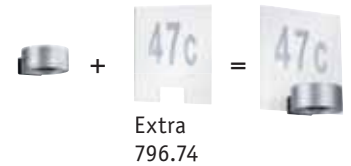

- ▶ Mit Wechseloptiken für geänderte Austrahlwinkel und Lichtwirkungen
- ▶ Hausnummernmodul nachträglich aufsteckbar

- ▶ Avec optiques interchangeable pour une modification de l'angle de rayonnement et des effets de lumière
- ▶ Module de numéro de maison encastrable a posteriori

- ▶ Met wisseloptieken voor een gewijzigde uitstraalhoek en lichteffecten
- ▶ Huisnummermodule achteraf opsteekbaar



incl. lens  
2x 30°, 2x 60°, 2x 90°

**Cone** A++-A

incl. 2x6W  
2x510 lm, 3.000 K  
∠ 30°-90°  
230V  
∅50 ∅110 ⇔110 ↗150 mm  
EAN 4000870 796757  
**796.75 new**

**Cone** A++-A

incl. 2x6W  
2x540 lm, 4.000 K  
∠ 30°-90°  
230V  
∅50 ∅110 ⇔110 ↗150 mm  
EAN 4000870 796795  
**796.79 new**



Silber/Anthrazit 田 Alu/Acryl  
 Argent/Anthracite 田 Alu/Acryl  
 Zilver/Antraciet 田 Alu/Acryl

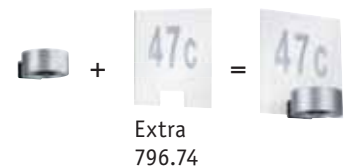

- ▶ Mit Wechseloptiken für geänderte Austrahlwinkel und Lichtwirkungen
- ▶ Hausnummernmodul nachträglich aufsteckbar

- ▶ Avec optiques interchangeable pour une modification de l'angle de rayonnement et des effets de lumière
- ▶ Module de numéro de maison encastrable a posteriori

- ▶ Met wisseloptieken voor een gewijzigde uitstraalhoek en lichteffecten
- ▶ Huisnummermodule achteraf opsteekbaar



incl. lens  
1x 30°, 1x 60°, 1x 90°

**Cone** A++-A

incl. 1x8W  
580 lm, 3.000 K  
∠ 30°-90°  
230V  
∅50 ∅110 ⇔110 ↗150 mm  
EAN 4000870 796764  
**796.76 new**

**Cone** A++-A

incl. 1x8W  
605 lm, 4.000 K  
∠ 30°-90°  
230V  
∅50 ∅110 ⇔110 ↗150 mm  
EAN 4000870 796801  
**796.80 new**



- 🌀 Silber/Anthrazit 🗪 Alu/Acryl
- 🌀 Argent/Anthracite 🗪 Alu/Acryl
- 🌀 Zilver/Antraciet 🗪 Alu/Acryl



 + 
 
 = 
 

**120°**  
 max. 10m  
 2-2500 Lux  
 Time 5s-13 min

Extra  
**796.74**

- ▶ Mit Wechsoptiken für geänderte Austrahlwinkel und Lichtwirkungen
- ▶ Mit Bewegungsmelder
- ▶ Hausnummernmodul nachträglich aufsteckbar

- ▶ Avec optiques interchangeable pour une modification de l'angle de rayonnement et des effets de lumière
- ▶ Avec détecteur de mouvement
- ▶ Module de numéro de maison encastrable a posteriori

- ▶ Met wisseloptieken voor een gewijzigde uitstraalhoek en lichteffecten
- ▶ Met bewegingsmelder
- ▶ Huisnummermodule achteraf opsteekbaar



**Cone** A++-A

incl. 2x6W  
 2x510 lm, 3.000 K  
 <math>\sphericalangle</math> 30°-90°  
 230V  
 ⌀138 ⌀110 ⇄110 ↗155 mm  
 EAN 4000870 796771  
**796.77 new**

**Cone** A++-A

incl. 2x6W  
 2x540 lm, 4.000 K  
 <math>\sphericalangle</math> 30°-90°  
 230V  
 ⌀138 ⌀110 ⇄110 ↗155 mm  
 EAN 4000870 796818  
**796.81 new**



**Cone** A++-A

incl. 1x8W  
 580 lm, 3.000 K  
 <math>\sphericalangle</math> 30°-90°  
 230V  
 ⌀138 ⌀110 ⇄110 ↗155 mm  
 EAN 4000870 796788  
**796.78 new**



- 🌀 Transparent 🗪 Kunststoff
- 🌀 Transparent 🗪 Matière plastique
- 🌀 Transparant 🗪 Kunststof

 + 
 
 = 
 

Extra



**Cone House Number**

⌀200 ⇄240 ↗4 mm  
 EAN 4000870 796740  
**796.74 new**

- ↳ Schwarz/Alu gebürstet  Alu Zink
- ↳ Noir/Alu brossé  Alu zinc
- ↳ Zwart/Alu geborsteld  Alu zink

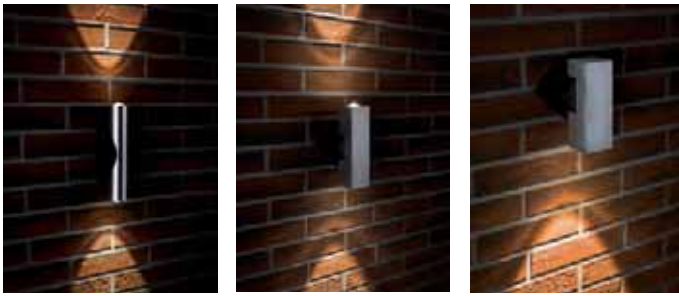
**2Flame**

incl. 2×3,2 W  
2×360 lm, 2.700 K  
∠ 45°, 460 cd  
230 V  
∅240 ⇄55 ∅80 mm  
EAN 4000870 180044  
**180.04**

**2Flame**

incl. 2×3,2 W  
2×360 lm, 2.700 K  
∠ 45°, 460 cd  
230 V  
∅210 ⇄120 ∅115 mm  
EAN 4000870 180051  
**180.05**

**1Flame**

incl. 1×3,2 W  
360 lm, 2.700 K  
∠ 45°, 460 cd  
230 V  
∅170 ⇄120 ∅115 mm  
EAN 4000870 180068  
**180.06**

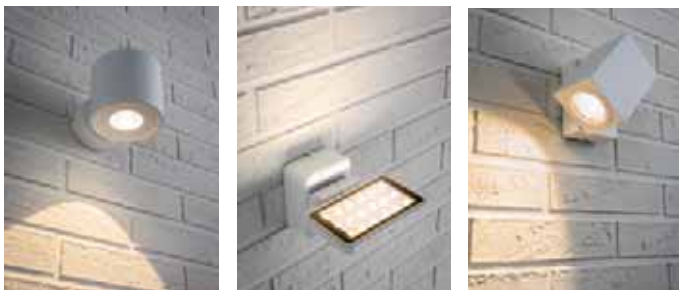

- ↳ Weiß matt  Alu
- ↳ Blanc dépoli  Alu
- ↳ Wit mat  Alu

**Big Flame**

incl. 1×5 W  
436 lm, 2.700 K  
∠ 60°  
230 V  
∅103 ∅103 ⇄103 ∅143 mm  
EAN 4000870 180075  
**180.07**

**Board**

incl. 1×7,2 W  
420 lm, 2.700 K  
∠ 100°  
230 V, incl. ⚡ 6 VA  
∅90 ⇄130 ∅135 mm  
EAN 4000870 937815  
**937.81**

**360° Cube Flame**

incl. 1×7 W  
240 lm, 2.700 K  
∠ 32°  
230 V, incl. ⚡ 8,3 VA  
∅100 ⇄105 ∅105 mm  
EAN 4000870 937822  
**937.82**



- 🔩 Eisen gebürstet 🏠 Alu
- 🔩 Acier brossé 🏠 Alu
- 🔩 Staal geborsteld 🏠 Alu



**Flame**

< A++-E

incl. 1x3,5 W, GU10, <math>\triangleleft A^+></math>  
 230 lm, 2.700 K  
 230 V  
 ⚡ 125 ⌀60 ⇔70 ↗95 mm  
 EAN 4000870 180082

**180.08**

💡 282.99

LED  
 IP44  
 rost  
 frei  
 ⚡

**Flame**

< A++-E

incl. 2x3,5 W, GU10, <math>\triangleleft A^+></math>  
 2x230 lm, 2.700 K  
 230 V  
 ⚡ 210 ⌀60 ⇔70 ↗95 mm  
 EAN 4000870 180099

**180.09**

💡 282.99



LED  
 IP44  
 rost  
 frei  
 ⚡







⌘ Grau  Alu  
 ⌘ Gris  Alu  
 ⌘ Grijs  Alu

⌘ Weiß  Alu  
 ⌘ Blanc  Alu  
 ⌘ Wit  Alu

↘ 40-120°

► Ausstrahlwinkel 40-120° variabel  
einstellbar durch Klappmechanismus

► Angle de rayonnement variable de 40 à  
120° réglable par un mécanisme de pliage

► Uitstraalhoek 40-120° variabel instelbaar  
door klapmechanisme



### Cybo

incl. 2×3 W  
 2×355 lm, 2.700 K  
 ↘ 40°-120°  
 230 V  
 ⌀80 ⇄80 ⤵80 mm  
 EAN 4000870 180006  
**180.00**

A++-A





### Cybo

incl. 2×3 W  
 2×355 lm, 2.700 K  
 ↘ 40°-120°  
 230 V  
 ⌀80 ⇄80 ⤵80 mm  
 EAN 4000870 180013  
**180.01**

A++-A



⌘ Grau  Alu  
 ⌘ Gris  Alu  
 ⌘ Grijs  Alu

⌘ Weiß  Alu  
 ⌘ Blanc  Alu  
 ⌘ Wit  Alu

► Ausstrahlwinkel 85°  
 ► Licht 355° drehbar

► Angle de rayonnement de 85°  
 ► Éclairage orientable sur 355°

► Uitstraalhoek 85°  
 ► Licht 355° draaibaar

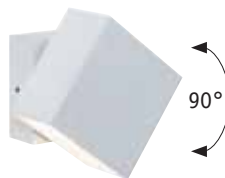

### Cybo

incl. 2×3 W  
 2×355 lm, 2.700 K  
 ↘ 85°  
 230 V  
 ⌀93 ⇄100 ⤵100 mm  
 EAN 4000870 180020  
**180.02**

A++-A



### Cybo

incl. 2×3 W  
 2×355 lm, 2.700 K  
 ↘ 85°  
 230 V  
 ⌀93 ⇄100 ⤵100 mm  
 EAN 4000870 180037  
**180.03**

A++-A





**Slot LED**

A++-A

incl. 1x2,4 W  
120 lm, 2.700 K  
∠ 30°  
230 V  
⇅160 ⇄90 mm  
EAN 4000870 938263  
**938.26**

LED  
IP44  
ALU  
rost  
frei

- ☞ Alu matt ▣ Alu
- ☞ Alu mat ▣ Alu
- ☞ Alu mat ▣ Alu



**Slot LED**

A++-A

incl. 1x2,4 W  
120 lm, 2.700 K  
∠ 30°  
230 V  
⇅160 ⇄90 mm  
EAN 4000870 938089  
**938.08**

LED  
IP44  
ALU  
rost  
frei

- ☞ Weiß ▣ Alu
- ☞ Blanc ▣ Alu
- ☞ Wit ▣ Alu



**Slot LED**

A++-A

incl. 1x2,4 W  
120 lm, 2.700 K  
∠ 30°  
230 V  
⇅163 ⇄93 ↗41 mm  
EAN 4000870 938256  
**938.25**

LED  
IP44  
ALU  
rost  
frei

- ☞ Alu matt ▣ Alu
- ☞ Alu mat ▣ Alu
- ☞ Alu mat ▣ Alu



**Slot LED**

A++-A

incl. 1x2,4 W  
120 lm, 2.700 K  
∠ 30°  
230 V  
⇅163 ⇄93 ↗41 mm  
EAN 4000870 938096  
**938.09**

LED  
IP44  
ALU  
rost  
frei

- ☞ Weiß ▣ Alu
- ☞ Blanc ▣ Alu
- ☞ Wit ▣ Alu

**Wall LED**

incl. 1×2,4 W  
6 lm, 6.500 K  
230 V  
⇅162 ⇄97 ↻79 mm  
EAN 4000870 998182  
**998.18**

- 🔗 Titan  Alu
- 🔗 Titane  Alu
- 🔗 Titaan  Alu

A++-A

LED

IP44

ALU

rost

frei

D-

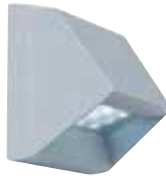
**Wall LED**

incl. 1×1,5 W  
29 lm, 6.500 K  
230 V  
⇅86 ⇄90 ↻63 mm  
EAN 4000870 998175  
**998.17**

- 🔗 Titan  Alu
- 🔗 Titane  Alu
- 🔗 Titaan  Alu

A++-A

LED

IP44

ALU

rost

frei

D-



- 🔗 Edelstahl  Edelstahl
- 🔗 Acier inoxydable  Acier inoxydable
- 🔗 Edeldstaal  edeldstaal

**Wall LED**

incl. 1×1,2 W  
27 lm, 6.500 K  
230 V  
⇄170 ↻68 mm  
EAN 4000870 998168  
**998.16**

A++-A

LED

IP65

ALU

rost

frei

D-



- ▶ Mit dekorativen Gläsern erweiterbar
- ▶ Betrieb direkt mit 230 V
- ▶ Extensibles avec des verreries décoratives
- ▶ Fonctionnement direct avec 230 V
- ▶ Met decoratieve glazen uitbreidbaar
- ▶ Rechtstreeks bedrijf met 230 V

- ↳ Weiß matt ▣ Alu Zink
- ↳ Blanc dépoli ▣ Alu zinc
- ↳ Wit mat ▣ Alu zink



**AmbientLED** A++-A

incl. 1x2,4 W  
 110 lm, 2.700 K  
 ∠ 30°  
 230 V, incl. ⚡ 3,6 VA  
 ⚡60 ⚡100 ⚡115 mm  
 EAN 4000870 938119  
**938.11**

LED  
 IP44  
 ALU  
 rost  
 frei



**AmbientLED Dekor** rost  
frei

⚡130 ⚡98 mm  
 EAN 4000870 938126  
**938.12**  
 ↳ Satin ▣ Acryl  
 ↳ Satiné ▣ Acryl  
 ↳ Satijn ▣ Acryl



**AmbientLED Dekor** rost  
frei

⚡130 ⚡98 ⚡60 mm  
 EAN 4000870 938133  
**938.13**  
 ↳ Weiß matt/Gold ▣ Alu  
 ↳ Blanc dépoli/Doré ▣ Alu  
 ↳ Wit mat/Goud ▣ Alu



**AmbientLED Dekor** rost  
frei







⚡130 ⚡98 mm  
 EAN 4000870 938140  
**938.14**  
 ↳ Alu gebürstet ▣ Alu  
 ↳ Alu brossé ▣ Alu  
 ↳ Alu geborsteld ▣ Alu



**AmbientLED** A++-A

incl. 1x2,4 W  
 110 lm, 2.700 K  
 ∠ 30°  
 230 V, incl. ⚡ 3,6 VA  
 ⚡600 ⚡100 ⚡145 mm  
 EAN 4000870 938157  
**938.15**

LED  
 IP44  
 ALU  
 rost  
 frei

 Silber  Metall/Acryl  
 Argent  Métal/Acryl  
 Zilver  Metaal/Acryl



#### House Downlight 230V

incl. 1×4,4 W  
 530 lm, 3.000 K  
 ↘ 34°  
 230 V  
 ⌀3 ø95 mm  
 EAN 4000870 796665  
**796.66 new**

A++-A



#### House Downlight 230V

incl. 1×5,3 W  
 600 lm, 3.000 K  
 ↘ 55°  
 230 V  
 ⌀3 ø95 mm  
 EAN 4000870 796689  
**796.68 new**

A++-A



#### House Downlight 230V

incl. 1×4,4 W  
 590 lm, 4.000 K  
 ↘ 34°  
 230 V  
 ⌀3 ø95 mm  
 EAN 4000870 796672  
**796.67 new**

A++-A









#### House Downlight 230V

incl. 1×5,3 W  
 660 lm, 4.000 K  
 ↘ 55°  
 230 V  
 ⌀3 ø95 mm  
 EAN 4000870 796696  
**796.69 new**

A++-A



 Anthrazit  Alu/Acryl  
 Anthracite  Alu/Acryl  
 Antraciet  Alu/Acryl



#### House surface mounted Downlight 230V

incl. 1×4,4 W  
 530 lm, 3.000 K  
 ↘ 34°  
 230 V  
 ⌀95 ø95 mm  
 EAN 4000870 796702  
**796.70 new**

A++-A



#### House surface mounted Downlight 230V

incl. 1×5,3 W  
 600 lm, 3.000 K  
 ↘ 55°  
 230 V  
 ⌀95 ø95 mm  
 EAN 4000870 796726  
**796.72 new**

A++-A



#### House surface mounted Downlight 230V

incl. 1×4,4 W  
 590 lm, 4.000 K  
 ↘ 34°  
 230 V  
 ⌀95 ø95 mm  
 EAN 4000870 796719  
**796.71 new**

A++-A



#### House surface mounted Downlight 230V

incl. 1×5,3 W  
 660 lm, 4.000 K  
 ↘ 55°  
 230 V  
 ⌀95 ø95 mm  
 EAN 4000870 796733  
**796.73 new**

A++-A





Alu Alu  
Alu Alu  
Alu Alu



Schwarz Alu  
Noir Alu  
Zwart Alu



**Line Garden Spot**

max. 28 W, GU10  
230 V  
∅320 ∅98 ↔100 mm  
EAN 4000870 937518  
**937.51**

LED = 415-450

A++-E

IP44

IP65

ALU  
rost  
frei



**Line Garden Spot**

incl. 1×3,5 W, GU10,   
230 lm, 3.000 K  
230 V  
∅320 ∅92 mm  
EAN 4000870 988961  
**988.96 new**

A++-E

IP44

IP65



**Line Garden Spot**

incl. 3×3,5 W, GU10,   
3×230 lm, 3.000 K  
230 V  
∅320 ∅92 mm  
EAN 4000870 988978  
**988.97 new**

A++-E

IP44

IP65



Edelstahl Metall  
Acier inoxydable Métal  
Edelstaal Metaal

- ▶ Staubdicht und wasserdicht bei zeitweiligem Untertauchen (IP67)
- ▶ Betrieb direkt mit 230 V

- ▶ Protection contre la poussière et l'immersion temporaire (IP67)
- ▶ Fonctionnement direct avec 230 V

- ▶ Stofdicht en waterdicht bij tijdelijke onderdompeling (IP67)
- ▶ Rechtstreeks bedrijf met 230 V



**Line Floor LED**

incl. 1×3,5 W, GU10,   
230 lm, 3.000 K  
230 V  
∅124 ∅108 mm  
EAN 4000870 939925  
**939.92 new**

A++-E

IP67

rost  
frei



**Line Floor LED**

incl. 1×3,5 W, GU10,   
230 lm, 3.000 K  
230 V  
∅124 ↔108 ↗108 mm  
EAN 4000870 939932  
**939.93 new**

A++-E

IP67

rost  
frei

- 🔗 Edelstahl 🗎 Metall
- 🔗 Acier inoxydable 🗎 Métal
- 🔗 Edelstaal 🗎 Metaal



incl.  
diffusor

- ▶ Mitgelieferter Diffusor ermöglicht wahlweise akzentuiertes oder diffuses Licht
- ▶ Betrieb direkt mit 230 V
- ▶ Le diffuseur inclus permet de sélectionner une lumière soutenue ou diffuse
- ▶ Fonctionnement direct avec 230 V
- ▶ Meegeleverde diffusor maakt naar keuze geaccentueerd of diffuus licht mogelijk
- ▶ Rechtstreeks bedrijf met 230 V



#### Line Floor LED

incl. 1x1,2 W  
30 lm, 2.700 K  
☼ 120°, 17 cd  
230 V  
⇅132 ø110 mm  
EAN 4000870 937884  
**937.88**



#### Line Floor LED

incl. 1x1,2 W  
30 lm, 6.500 K  
☼ 120°, 1,5 cd  
230 V  
⇅132 ø110 mm  
EAN 4000870 988756  
**988.75**



- 🔗 Edelstahl 🗎 Metall
- 🔗 Acier inoxydable 🗎 Métal
- 🔗 Edelstaal 🗎 Metaal

- ▶ Staubdicht und wasserdicht bei zeitweiligem Untertauchen (IP67)
- ▶ Belastbar bis 1.700kg
- ▶ Betrieb direkt mit 230 V
- ▶ Protection contre la poussière et l'immersion temporaire (IP67)
- ▶ Charge max. 1 700 kg
- ▶ Fonctionnement direct avec 230 V
- ▶ Stofdicht en waterdicht bij tijdelijke onderdompeling (IP67)
- ▶ Belastbaar tot 1.700kg
- ▶ Rechtstreeks bedrijf met 230 V



#### Line Floor LED

incl. 1x2,5 W  
35 lm, 2.700 K  
☼ 85°  
230 V  
⇅90 ⇄185 ↗136 mm  
EAN 4000870 937969  
**937.96**



#### Line Floor LED

incl. 1x2,5 W  
35 lm, 6.500 K  
☼ 85°  
230 V  
⇅90 ⇄185 ↗136 mm  
EAN 4000870 937976  
**937.97**





🔗 Schwarz 📦 Kunststoff  
🔗 Noir 📦 Matière plastique  
🔗 Zwart 📦 Kunststof

- ▶ Verbindungsbox für bis zu 4 Leitungen
- ▶ Nicht benötigte Abgänge bleiben verschlossen
- ▶ Staubdicht und wasserdicht bei zeitweiligem Untertauchen (IP67)
- ▶ Boîte de connexion pour 4 câbles max.
- ▶ Les sorties inutilisées restent fermées
- ▶ Protection contre la poussière et l'immersion temporaire (IP67)
- ▶ Verbindingsbox voor max. 4 leidingen
- ▶ Niet benodigde aftappunten blijven gesloten
- ▶ Stofdicht en waterdicht bij tijdelijke onderdompeling (IP67)

6-12mm 



**Junction-Box 230V**

max. 2.500 W  
 ⌀140 ⇄110 ⚙55 mm  
 EAN 4000870 002322  
**232** 

  
IP67



🔗 Schwarz 📦 Kunststoff  
🔗 Noir 📦 Matière plastique  
🔗 Zwart 📦 Kunststof

- ▶ Verbindungsbox für bis zu 3 Leitungen
- ▶ Nicht benötigte Abgänge bleiben verschlossen
- ▶ Staubdicht und wasserdicht bei dauerhaften Untertauchen (IP68)
- ▶ Boîte de connexion pour 3 câbles max.
- ▶ Les sorties inutilisées restent fermées
- ▶ Protection contre la poussière et l'immersion permanent (IP68)
- ▶ Verbindingsbox voor max. 3 leidingen
- ▶ Niet benodigde aftappunten blijven gesloten
- ▶ Stofdicht en waterdicht bij permanente onderdompeling (IP68)

12-15mm 



**Junction-Box 230V**

max. 2.500 W  
 ⌀134 ⇄105 ⚙53 mm  
 EAN 4000870 002377  
**237** 

  
IP68





Alu Alu  
Alu Alu  
Alu Alu



### Garden Spot LED Set

incl. 3x3 W

3.000 K

∠ 45°, 275 cd

230/12V, incl. 16 VA

∅310 mm ∅96 mm ∅100 mm ⇄2 m

EAN 4000870 988459

**988.45**

A++-A

LED

IP44

IP65

ALU

rost  
frei

∅





Satin Polycarbonat  
 Satiné Polycarbonate  
 Satijn Polycarbonaat

- ▶ Basisset kann mit Ergänzungsset auf bis zu 20 Lichtpunkte erweitert werden
- ▶ Einfachste Montage durch Steckverbindung

- ▶ Jusqu'à 20 points de lumière sont possibles en combinant le kit de base et le kit d'extension
- ▶ Montage particulièrement simple par connexion rapide

- ▶ Basisset kan met aanvullingsset tot 20 lichtpunten worden uitgebreid
- ▶ Eenvoudige montage door steekverbinding



#### Micro IP67 Set

incl. 5x0,16 W  
 6.500 K  
 230/12 V, incl. 6 VA  
 ∅20 ø14 mm  
 EAN 4000870 988916  
**988.91**

A++-A



#### Micro IP67 Extension Set

incl. 5x0,16 W  
 6.500 K  
 DC 12 V  
 ∅20 ø14 mm  
 EAN 4000870 988923  
**988.92**

A++-A





🔑 Edelmetal 𠄎 Edelmetal  
 🔑 Acier inoxydable  
 𠄎 Acier inoxydable  
 🔑 Edelmetal 𠄎 edelmetal

- ▶ Basisset kann mit Ergänzungsset auf bis zu 25 Lichtpunkte erweitert werden 4x 937.59
- ▶ Einfachste Montage durch Steckverbindung
- ▶ Montage in Materialien von 3 bis 35 mm
- ▶ Jusqu'à 25 points de lumière sont possibles en combinant le kit de base et le kit d'extension 4x 937.59
- ▶ Montage particulièrement simple par connexion rapide
- ▶ Montage dans des matériaux de 3 à 35 mm d'épaisseur
- ▶ Basisset kan met aanvullingsset tot 25 lichtpunten worden uitgebreid 4x 937.59
- ▶ Eenvoudige montage door steekverbinding
- ▶ Montage in materiaal van 3 tot 35 mm



#### MicroPen IP67 Basic

incl. 5x0,16 W  
 3.000 K  
 ∠ 30°, 1,4 cd  
 230/12 V, incl. - 6 VA  
 ø15 mm  
 EAN 4000870 937549  
**937.54**



#### MicroPen IP67 Extra

incl. 5x0,16 W  
 3.000 K  
 ∠ 30°, 1,4 cd  
 DC 12 V  
 ø15 mm  
 EAN 4000870 937594  
**937.59**

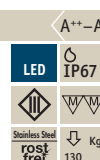



- 🔩 Edelstahl  Edelstahl
- 🔩 Acier inoxydable  Acier inoxydable
- 🔩 Edellaal  edellaal

- ▶ Basisset kann mit Ergänzungsset auf bis zu 12 Lichtpunkte erweitert werden
- ▶ Einfache Montage durch IP geschützte Schraubverbindungen
- ▶ Jusqu'à 12 points de lumière sont possibles en combinant le kit de base et le kit d'extension
- ▶ Montage facilitée par raccords vissés à protection IP
- ▶ Basisset kan met aanvullingsset tot 12 lichtpunten worden uitgebreid
- ▶ Eenvoudige montage met IP beschermde schroefverbindingen

**MiniPlus Basic**

incl. 4x0,7 W  
4x28 lm, 2.700 K  
230/12 V, incl. ⚡ 16 VA  
⌀83 ⇄43 ⚡43 mm  
EAN 4000870 937860  
**937.86**

A++-A

LED IP44

IP67

Stainless Steel  
rost  
frei

500 Kg

**MiniPlus Basic**

incl. 4x0,7 W  
4x28 lm, 2.700 K  
230/12 V, incl. ⚡ 16 VA  
⌀83 ⌀43 mm  
EAN 4000870 937846  
**937.84**

A++-A

LED IP44

IP67

Stainless Steel  
rost  
frei

500 Kg

**MiniPlus Extra**

incl. 4x0,7 W  
4x28 lm, 2.700 K  
12 V  
⌀83 ⇄43 ⚡43 mm  
EAN 4000870 937853  
**937.85**

A++-A

LED IP67

Stainless Steel  
rost  
frei

500 Kg

**MiniPlus Extra**

incl. 4x0,7 W  
4x28 lm, 2.700 K  
12 V  
⌀83 ⌀43 mm  
EAN 4000870 937839  
**937.83**

A++-A

LED IP67

Stainless Steel  
rost  
frei

500 Kg

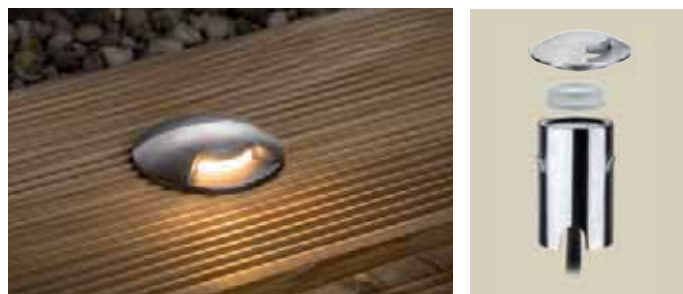

- 🔩 Edelstahl  Edelstahl
- 🔩 Acier inoxydable  Acier inoxydable
- 🔩 Edellaal  edellaal

- ▶ Dekorativer Blendschutz für die MiniPlus Boden Einbauleuchte
- ▶ Protection décorative anti-éblouissement pour l'encasturé de sol MiniPlus
- ▶ Decoratieve optionele bescherming voor de MiniPlus vloer inbouwlampen

**MiniPlus Cover**

⌀10 ⌀47 mm  
EAN 4000870 937907  
**937.90**

Stainless Steel  
rost  
frei

140 Kg



- 🔗 Edelstahl 🗪 Edelstahl
- 🔗 Acier inoxydable
- 🗪 Acier inoxydable
- 🔗 Edellaal 🗪 edellaal

- ▶ Basisset kann mit Ergänzungsset auf bis zu 12 Lichtpunkte erweitert werden
- ▶ Einfache Montage durch IP geschützte Schraubverbindungen
- ▶ Jusqu'à 12 points de lumière sont possibles en combinant le kit de base et le kit d'extension
- ▶ Montage facilitée par raccords vissés à protection IP
- ▶ Basisset kan met aanvullingsset tot 12 lichtpunten worden uitgebreid
- ▶ Eenvoudige montage met IP beschermde schroefverbindingen



**Mini Basic**

incl. 4x0,6 W  
7.000 K  
230/12 V, incl. ⚡ 6 VA  
⌀33 ⇄44 ⚡44 mm  
EAN 4000870 988701  
**988.70**

A++-A

LED IP44

IP65

Stainless Steel  
rost  
frei

500 Kg



**Mini Basic**

incl. 4x0,6 W  
7.000 K  
230/12 V, incl. ⚡ 6 VA  
⌀33 ⌀44 mm  
EAN 4000870 988688  
**988.68**

A++-A

LED IP44

IP65

Stainless Steel  
rost  
frei

500 Kg



**Mini Extra**

incl. 4x0,6 W  
7.000 K  
12 V  
⌀33 ⇄44 ⚡44 mm  
EAN 4000870 988718  
**988.71**

A++-A

LED IP65

Stainless Steel  
rost  
frei

500 Kg



**Mini Extra**

incl. 4x0,6 W  
7.000 K  
12 V  
⌀33 ⌀44 mm  
EAN 4000870 988695  
**988.69**

A++-A

LED IP65

Stainless Steel  
rost  
frei

500 Kg



incl. Diffusor

- 🔗 Edelstahl 🗪 Metall
- 🔗 Acier inoxydable 🗪 Métal
- 🔗 Edellaal 🗪 Metaal

- ▶ Mitgelieferter Diffusor ermöglicht wahlweise akzentuiertes oder diffuses Licht
- ▶ Le diffuseur inclus permet de sélectionner une lumière soutenue ou diffuse
- ▶ Meegeleverde diffusor maakt naar keuze geaccentueerd of diffuus licht mogelijk



**Floor LED**

incl. 3x1,2 W  
3x35 lm, 2.700 K  
⊘ 120°, 17 cd  
230/12 V, incl. ⚡ 10,5 VA  
⌀80 ⇄100 ⚡100 mm  
EAN 4000870 937877  
**937.87**

A++-A

LED IP44

IP65

Stainless Steel  
rost  
frei

500 Kg



**Floor LED**

incl. 3x1,2 W  
6.500 K  
⊘ 120°, 1,5 cd  
230/12 V, incl. ⚡ 10,5 VA  
⌀80 ⇄100 ⚡100 mm  
EAN 4000870 988763  
**988.76**

A++-A

LED IP44

IP65

Stainless Steel  
rost  
frei

500 Kg



- 🔗 Edeldstahl 📦 Metall
- 🔗 Acier inoxydable 📦 Métal
- 🔗 Edeldstaal 📦 Metaal

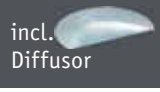

incl. Diffusor

- ▶ Mitgelieferter Diffusor ermöglicht wahlweise akzentuiertes oder diffuses Licht
- ▶ Le diffuseur inclus permet de sélectionner une lumière soutenue ou diffuse
- ▶ Meegeleverde diffusor maakt naar keuze geaccentueerd of diffuus licht mogelijk



**Floor LED**  
 incl. 3×1,2W  
 3×35 lm, 2.700 K  
 ∠ 120°, 17 cd  
 230/12V, incl. ⚡ 10,5 VA  
 ⚙ 80 ø98 mm  
 EAN 4000870 937891  
**937.89**

A\*\*–A

LED

🔗 IP44

🔗 IP65

📦

📏

Stainless Steel

rost frei

⬇ Kg

500



**Floor LED**  
 incl. 3×1,2W  
 6.500 K  
 ∠ 120°, 1,5 cd  
 230/12V, incl. ⚡ 10,5 VA  
 ⚙ 80 ø98 mm  
 EAN 4000870 988770  
**988.77**

A\*\*–A

LED

🔗 IP44

🔗 IP65

📦

📏

Stainless Steel

rost frei

⬇ Kg

500



- 🔗 Edeldstahl 📦 Edeldstahl
- 🔗 Acier inoxydable
- 📦 Acier inoxydable
- 🔗 Edeldstaal 📦 edeldstaal

- ▶ Staubdicht und wasserdicht bei zeitweiligem Untertauchen (IP67)
- ▶ Durch das integrierte Betriebsgerät direkt an 230V anschließbar.
- ▶ Protection contre la poussière et l'immersion temporaire (IP67)
- ▶ Branchement direct sur 230V.
- ▶ Stofdicht en waterdicht bij tijdelijke onderdompeling (IP67)
- ▶ Door het geïntegreerde bedrijfsapparaat direct op de bestaande huisbedrading (230V) aansluitbaar.



**Floor LED 2,1W**  
 incl. 1×2,1W  
 60 lm, 6.500 K  
 230/12V, incl. ⚡ 3,6 VA  
 ⚙ 100 ø180 mm  
 EAN 4000870 937464  
**937.46**

A\*\*–A

LED

🔗 IP67

📦

📏

Stainless Steel

rost frei

⬇ Kg

500



- ↳ Schwarz ☐ Gummi
- ↳ Noir ☐ Caoutchouc
- ↳ Zwart ☐ Rubber

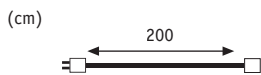

**IP65 Connector 12V**

max. 100 W  
 12 V  
 ⇄ 2 m  
 EAN 4000870 938232  
**938.23** 🚚



**IP65 Connector 12V**

max. 100 W  
 12 V  
 ⇄ 5 m  
 EAN 4000870 988466  
**988.46** 🚚



**IP65 Connector 12V**

max. 100 W  
 12 V  
 ⇄ 10 m  
 EAN 4000870 938249  
**938.24** 🚚



**IP65 Connector 12V**

max. 100 W  
 12 V  
 ⌀52 ⇄58 ⚡18 mm  
 EAN 4000870 938331  
**938.33** 🚚



- ↳ Schwarz ☐ Kunststoff
- ↳ Noir ☐ Matière plastique
- ↳ Zwart ☐ Kunststof



- ↳ Schwarz ☐ Alu
- ↳ Noir ☐ Alu
- ↳ Zwart ☐ Alu



**Outdoorbox IP65**

⌀102 ⇄146 ⚡240 mm  
 EAN 4000870 988473  
**988.47**



6-12mm 🚚





Solar

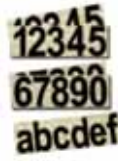

- 🔗 Edelstahl/Weiß 📦 Edelstahl/Acryl
- 🔗 Acier inoxydable/Blanc
- 📦 Acier inoxydable/Acryl
- 🔗 Edelstaal/Wit 📦 edelstaal/Acryl

- ▶ Ladezeit bei Sonnenausrichtung 6-8 Stunden, Leuchtdauer 4-6 Std.
- ▶ Durée de recharge à la lumière solaire 6-8 heures, durée d'éclairage 4-6 heures
- ▶ Oplaadtijd via zonne-energie 6-8 uur, gebruikstijd 4-6 uur.



**Solar House Number**

incl. 1x0,2W  
 3.000 K  
 AA-Akku/1,5V (Mignon) x 2  
 ⌀220 ⇄230 ↗60 mm  
 EAN 4000870 937655  
**937.65**

- LED
- 🌙
- ☀️
- IP44
- 📏
- Stainless Steel  
rost  
frei
- 🔗
- Incl.  
Accu



Solar



- 🔗 Edelstahl/Klar 📦 Edelstahl/Polycarbonat
- 🔗 Acier inoxydable/Clair 📦 Acier inoxydable/Polycarbonat
- 🔗 Edelstaal/Helder 📦 edelstaal/Polycarbonaat

- ▶ Ladezeit bei Sonnenausrichtung 6-8 Stunden, Leuchtdauer 8-10 Std.
- ▶ Durée de recharge à la lumière solaire 6-8 heures, durée d'éclairage 8-10 heures
- ▶ Oplaadtijd via zonne-energie 6-8 uur, gebruikstijd 8-10 uur.



**Solar Cube/Box LED**

incl. 1x0,24 W  
 3,6 lm, 2.700 K  
 AA-Akku/1,5V (Mignon) x 1  
 ⌀45 ⇄100 ↗100 mm  
 EAN 4000870 937747  
**937.74**

- LED
- 🌙
- ☀️
- IP67
- 📏
- Stainless Steel  
rost  
frei
- Incl.  
Accu
- ⬇️ Kg  
500



**Solar Cube/Box LED**

incl. 1x0,6 W  
 7,5 lm, 2.700 K  
 AA-Akku/1,5V (Mignon) x 2  
 ⌀51 ⇄200 ↗100 mm  
 EAN 4000870 937754  
**937.75**

- LED
- 🌙
- ☀️
- IP67
- 📏
- Stainless Steel  
rost  
frei
- Incl.  
Accu
- ⬇️ Kg  
500



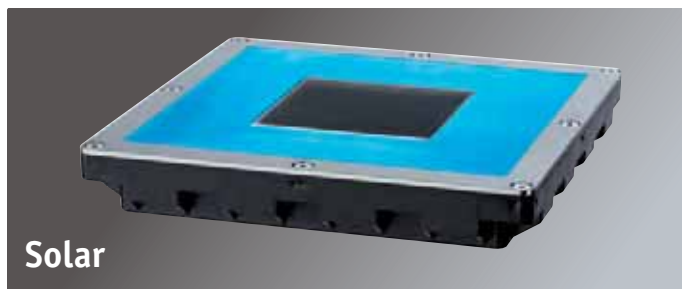

⌘ Edelstahl/RGB ⌘ Edelstahl/Polycarbonat  
 ⌘ Acier inoxydable/RGB ⌘ Acier inoxydable/Polycarbonate  
 ⌘ Edeltaal/RGB ⌘ edeltaal/Polycarbonaat

incl. color diffusor



- ▶ Ladezeit bei Sonnenausrichtung 6-8 Stunden, Leuchtdauer 8-10 Std.
- ▶ Durée de recharge à la lumière solaire 6-8 heures, durée d'éclairage 8-10 heures
- ▶ Oplaadtijd via zonne-energie 6-8 uur, gebruikstijd 8-10 uur.



#### Solar Cube LED Color

incl. 1x0,6 W  
 7,5 lm, 2.700 K  
 AA-Akku/1,5V (Mignon) x 2  
 ⌀33 ⇄200 ⌀200 mm  
 EAN 4000870 938348  
**938.34**



⌘ Edelstahl/Klar ⌘ Edelstahl/Glas  
 ⌘ Acier inoxydable/Clair ⌘ Acier inoxydable/Verre  
 ⌘ Edeltaal/Helder ⌘ edeltaal/Glas

- ▶ Ladezeit bei Sonnenausrichtung 6-8 Stunden, Leuchtdauer 8-10 Std.
- ▶ Durée de recharge à la lumière solaire 6-8 heures, durée d'éclairage 8-10 heures
- ▶ Oplaadtijd via zonne-energie 6-8 uur, gebruikstijd 8-10 uur.



#### Solar Pandora LED

incl. 1x0,36 W  
 9,8 lm, 2.700 K  
 AA-Akku/1,5V (Mignon) x 2  
 ⌀50 ⌀170 mm  
 EAN 4000870 937761  
**937.76**





⌘ Edelstahl/Klar ⌘⌘ Edelstahl/Glas  
 ⌘ Acier inoxydable/Clair ⌘⌘ Acier inoxydable/Verre  
 ⌘ Edellaal/Helder ⌘⌘ edellaal/Glas

► Ladezeit bei Sonnenausrichtung 6-8 Stunden, Leuchtdauer 8-10 Std.

► Durée de recharge à la lumière solaire 6-8 heures, durée d'éclairage 8-10 heures

► Oplaadtijd via zonne-energie 6-8 uur, gebruikstijd 8-10 uur.



**Solar Jupiter LED**

incl. 1x0,6 W  
 11 lm, 2.700 K  
 AA-Akku/1,5V (Mignon) x 2  
 ⚙40 ø250 mm  
 EAN 4000870 937778  
**937.77**

- LED
- ☀️
- ☾
- ⌚ IP67
- ⚡
- ⚡
- Stainless Steel
- roestvrij
- ⊕ incl.
- Accu
- ⬇️ Kg
- 1.000



⌘ Edelstahl/Schwarz ⌘⌘ Edelstahl/Kunststoff  
 ⌘ Acier inoxydable/Noir ⌘⌘ Acier inoxydable/Matière plastique  
 ⌘ Edellaal/Zwart ⌘⌘ edellaal/Kunststof

► Ladezeit bei Sonnenausrichtung 6-8 Stunden, Leuchtdauer 8-10 Std.

► Durée de recharge à la lumière solaire 6-8 heures, durée d'éclairage 8-10 heures

► Oplaadtijd via zonne-energie 6-8 uur, gebruikstijd 8-10 uur.



**Solar modul Floor**

incl. 5x0,2 W  
 5x4 lm, 2.700 K  
 < 120°  
 AA-Akku/1,5V (Mignon) x 3  
 DC 12 V  
 ⚙258 ø32 ⇔170 ↗170 mm  
 EAN 4000870 937679  
**937.67**

- LED
- ☀️
- ☾
- ⌚ IP67
- ⚡
- ⚡
- Stainless Steel
- roestvrij
- ⊕ incl.
- Accu
- ⬇️ Kg
- 130
- 📏

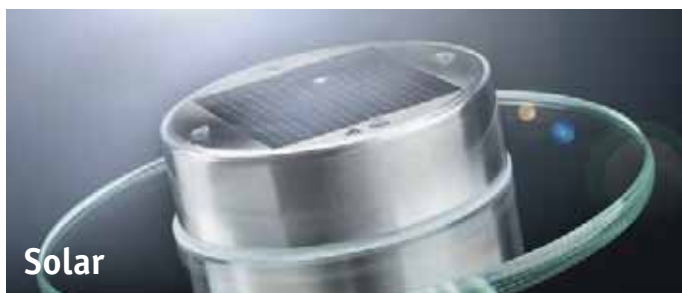

Edelstahl/Klar Edelstahl/Glas  
 Acier inoxydable/Clair Acier inoxydable/  
 Verre  
 Edelstaal/Helder edelstaal/Glas

► Ladezeit bei Sonnenausrichtung 6-8 Stunden, Leuchtdauer 3-5 Std.

► Durée de recharge à la lumière solaire 6-8 heures, durée d'éclairage 3-5 heures

► Oplaadtijd via zonne-energie 6-8 uur, gebruikstijd 3-5 uur.

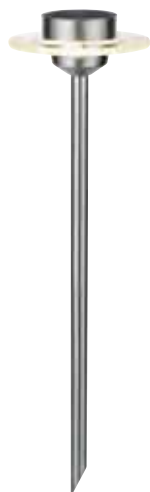

#### Solar Ufo LED

incl. 1x0,2W  
 3.000K  
 AAA-Akku/1,5V (Micro) x 2  
 ⌀550 ø150 mm  
 EAN 4000870 937648  
**937.64**

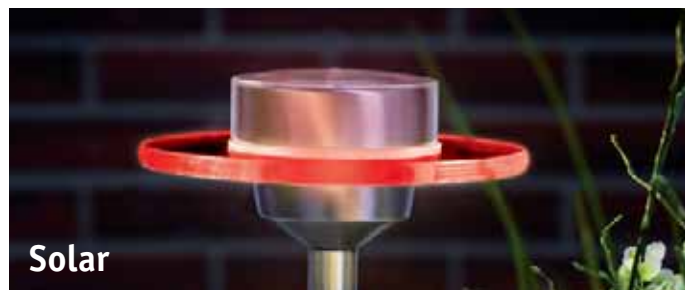

Edelstahl/Klar Edelstahl/Glas  
 Acier inoxydable/Clair Acier inoxydable/  
 Verre  
 Edelstaal/Helder edelstaal/Glas



► Ladezeit bei Sonnenausrichtung 6-8 Stunden, Leuchtdauer 3-5 Std.

► Durée de recharge à la lumière solaire 6-8 heures, durée d'éclairage 3-5 heures

► Oplaadtijd via zonne-energie 6-8 uur, gebruikstijd 3-5 uur.

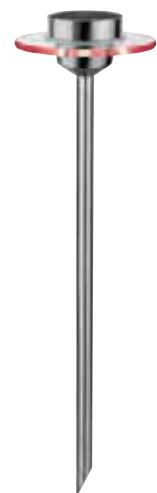

#### Solar Ufo LED RGB

incl. 1x0,2W  
 AAA-Akku/1,5V (Micro) x 2  
 ⌀550 ø150 mm  
 EAN 4000870 936993  
**936.99**



# Downlights

- 299 Wall
- 307 Floor
- 310 Ceiling
- 374 CabinetLight
- 389 2Easy
- 393 Accessories



357 Star Rolling



346 Premium Drip



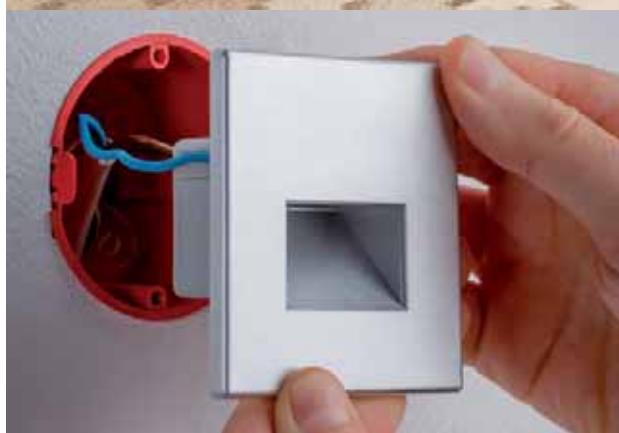

## Wall | Downlights

Wandeinbauleuchten für moderne Lichtakzentze, die als Orientierungslicht in Fluren und Treppenhäusern, Küchen und Bädern eingesetzt werden.

Encastrés muraux pour des touches de lumière modernes qui servent au balisage des couloirs et des cages d'escalier, des cuisines et des salles de bain.

Wandinbouwlampen voor moderne lichtaccenten, die als oriëntatielicht in gangen en trappenhuisen, keukens en badkamers worden ingezet.

*Kombinieren Sie selbst Ihr persönliches Lichtsystem*  
*Composez vous-même votre système d'éclairage personnel*  
*Combineer uw persoonlijk lichtstelsel zelf*

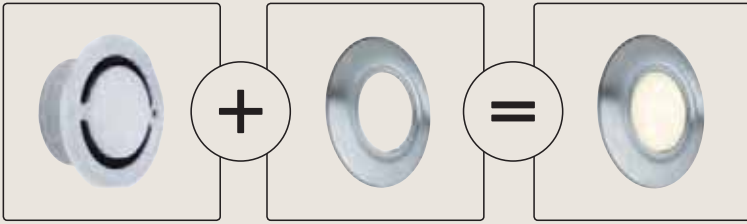

**IP65 Downlight Basic**

Polycarbonat Polycarbonate Polycarbonaat

- ▶ Werkzeuglose Montage der Edelstahldekore durch Klettverschluss
- ▶ Montage direkt in 60mm Einbaudosen möglich

- ▶ Fixation de l'habillage sans outils
- ▶ Possibilité de montage direct dans des embases encastrées de 60mm

- ▶ Met RVS-afdekking
- ▶ Rechtstreekse montage mogelijk in inbouwdozen van 60mm

Opal Opale Opaal



**incl. 1x1,4 W** <math>A^{++}-A</math>  
 3.000 K  
 230V  
 EAN 4000870 937402  
**937.40**



**incl. 1x1,4 W** <math>A^{++}-A</math>  
 4.000 K  
 230V  
 EAN 4000870 937419  
**937.41**

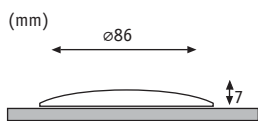
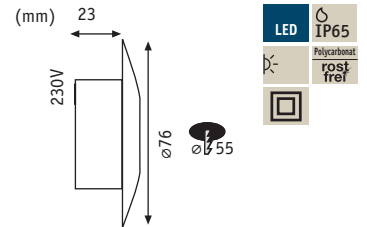

**Cover round**

$\updownarrow 7$   $\varnothing 86$  mm  
 EAN 4000870 937426  
**937.42**

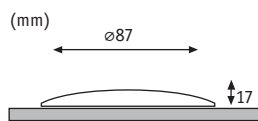

**Cover Cap round**

$\updownarrow 17$   $\varnothing 87$  mm  
 EAN 4000870 937433  
**937.43**

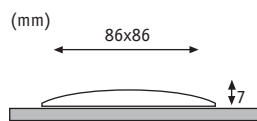

**Cover square**

$\updownarrow 7$   $\varnothing 86$   $\varnothing 86$  mm  
 EAN 4000870 937440  
**937.44**

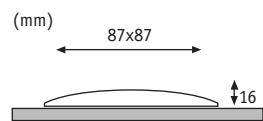

**Cover Cap square**

$\updownarrow 16$   $\varnothing 87$   $\varnothing 87$  mm  
 EAN 4000870 937457  
**937.45**



Wall 230V

Kunststoff Matière plastique Kunststoff



Wei Blanc Wit

**incl. 1x1,7 W** <A++-A

110 lm, 2.700 K

∠ 67°

230 V

EAN 4000870 929223

**929.22** new

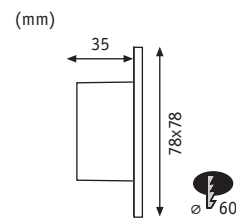

**incl. 1x2,7 W** <A++-A

100 lm, 2.700 K

∠ 72°

230 V

EAN 4000870 929230

**929.23** new

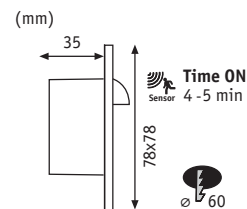

Wall 230V

Kunststoff Matière plastique Kunststoff



Wei Blanc Wit

**incl. 1x1,7 W** <A++-A

110 lm, 2.700 K

∠ 67°

230 V

EAN 4000870 929247

**929.24** new

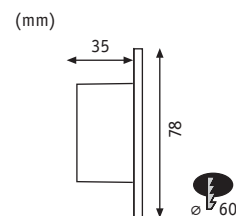

**incl. 1x2,7 W** <A++-A

100 lm, 2.700 K

∠ 72°

230 V

EAN 4000870 929254

**929.25** new

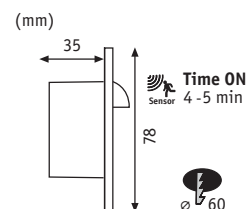

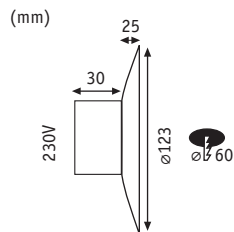

**Wall Downlight adjustable 230V**

☒ Kunststoff Matière plastique Kunststoff

- ▶ Bewegliche Dekorplatte lenkt das Licht
- ▶ Montage direkt in Hohlwanddosen möglich
- ▶ Passend zu Neordic Wohnraumleuchten
- ▶ La plaque décorative mobile dirige la lumière
- ▶ Montage direct possible dans prises pour cloisons creuses
- ▶ Convient aux éclairages Neordic
- ▶ Bewegbare decoratieve plaat leidt het licht
- ▶ Montage direct in de spouwmurdozen mogelijk
- ▶ Passend bij Neordic woonkamerlampen



☞ Weiß matt Blanc dépoli Wit mat

**incl. 1x2,5 W** <A++-A  
 180 lm, 2.700 K  
 230 V  
 EAN 4000870 929261  
**929.26 new**



☞ Beton/Weiß matt Béton/Blanc dépoli Beton/Wit mat

**incl. 1x2,5 W** <A++-A  
 180 lm, 2.700 K  
 230 V  
 EAN 4000870 929278  
**929.27 new**



☞ Marmor/Weiß matt Marbre/Blanc dépoli Marmer/Wit mat

**incl. 1x2,5 W** <A++-A  
 180 lm, 2.700 K  
 230 V  
 EAN 4000870 929285  
**929.28 new**



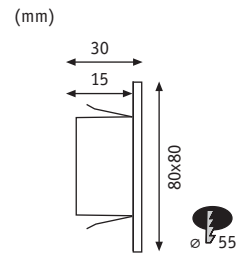
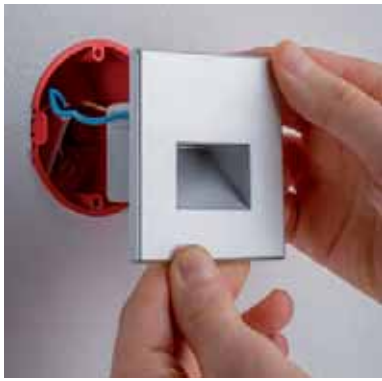

### Wall LED Edge

☒ Kunststoff Matière plastique Kunststof

- ▶ Eignet sich für gängige Hohlwanddosen
- ▶ 230V Wandlicht
- ▶ Convient aux prises pour cloisons creuses standard
- ▶ Applique murale 230 V
- ▶ Geschikt voor gangbare spouwmuurdosen
- ▶ 230V wandlamp



☞ Chrom matt Chrome mat Chroom mat

**incl. 1×1,1 W** ◀ A++-A

116 lm, 2.700 K

✕ 100°

230 V

EAN 4000870 994955

**994.95** €

000

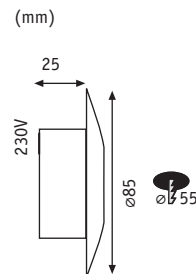

### Wall IP65 Downlight

☒ Metall/Kunststoff Métal/Matière plastique Metaal/Kunststof

- ▶ Montage direkt in 60mm Einbaudosen möglich
- ▶ Betrieb direkt mit 230 V
- ▶ Possibilité de montage direct dans des embases encastrées de 60mm
- ▶ Fonctionnement direct avec 230 V
- ▶ Rechtstreekse montage mogelijk in inbouwdozen van 60mm
- ▶ Rechtstreeks bedrijf met 230 V



☞ Nickel satiniert/Opal Nickel satiné/Opale Nikkel gesatineerd/Opaal

**incl. 1×0,25 W** ◀ A++-A

8,6 lm, 5.000 K

✕ 120°

230 V

EAN 4000870 989883

**989.88** €

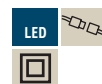
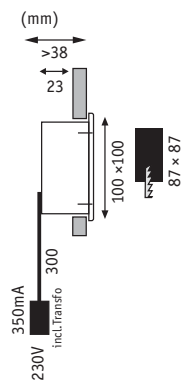

**Wall LED Quadro**

Alu Alu Alu

- ▶ Wird inkl. Einbaurahmen geliefert
- ▶ Livré avec un gabarit de montage
- ▶ Wordt geleverd incl. inbouwframe



Alu gebürstet Alu brossé Alu geborsteld

**incl. 1x2 W** A++-A

220 lm, 3.000 K

230 V, incl. 3 VA

EAN 4000870 937532

**937.53**



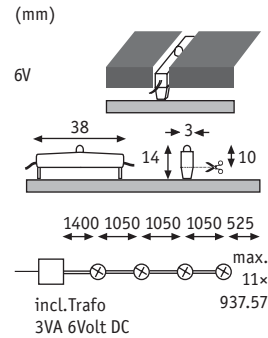

### GrooveLight Basic

☒ Kunststoff Matière plastique Kunststoff

- ▶ Das Produkt passt hervorragend in aktuelle Fliesenmaße.
  - ▶ Die Leuchte kann in Fliesenkreuzungen und auch in schmale Fugen von nur 3mm vertikal oder horizontal eingesetzt werden (Kabel können diagonal verlegt werden).
  - ▶ Basis-Set ist erweiterbar auf insgesamt 48 LED-Elemente bzw. 11 x 93757
- ▶ Le produit s'adapte remarquablement aux dimensions actuelles de carrelage.
  - ▶ La lampe peut être placée verticalement ou horizontalement entre les carreaux ou dans des joints, même étroits (3 mm), et les câbles posés en diagonale.
  - ▶ Le kit de base est extensible jusqu'à 48 éléments LED (11 x 93757)
- ▶ Het product past uitstekend in de actuele tegelmaten
  - ▶ De lamp kan in tegelkruizen en in smalle voegen van slechts 3 mm verticaal of horizontaal aangebracht worden (kabels kunnen diagonaal worden gelegd).
  - ▶ De basisset kan uitgebreid worden tot in totaal 48 LED-elementen of 11 x 93757



☒ Transparent Transparent Transparent

**incl. 4x0,02 W**

4x0,4 lm, 2.700 K  
230 V, incl. ☒ 3 VA  
EAN 4000870 937563

**937.56**

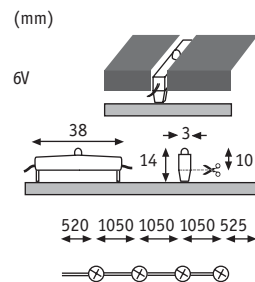

### GrooveLight Extra

☒ Kunststoff Matière plastique Kunststoff



☒ Transparent Transparent Transparent

**incl. 4x0,02 W**

4x0,4 lm, 2.700 K  
6 V  
EAN 4000870 937570  
**937.57**

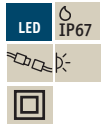
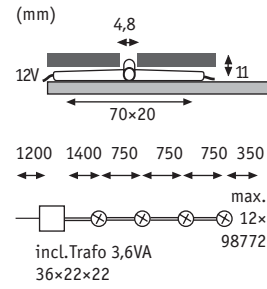

**Crosslight Basic**

☒ Kunststoff Matière plastique Kunststoff

- ▶ Basisset kann mit Ergänzungsset auf bis zu 12 Lichtpunkte erweitert werden
- ▶ Fliesenkreuz kann auch nachträglich eingebaut werden
- ▶ Jusqu'à 12 points de lumière sont possibles en combinant le kit de base et le kit d'extension
- ▶ La croix peut être installée sur du carrelage existant
- ▶ Basisset kan met aanvullingsset tot 12 lichtpunten worden uitgebreid
- ▶ Tegelkruis kan ook achteraf worden ingebouwd

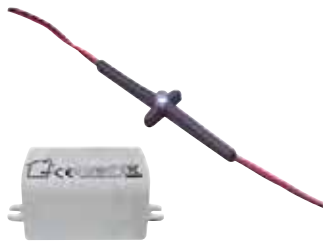

☞ Schwarz Noir Zwart

**incl. 4x0,275 W**

20.000 K

230/12 V, incl. ⚡ 3,6VA

EAN 4000870 987681

**987.68**

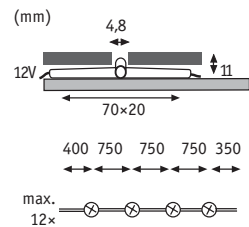

**Crosslight Extra**

☒ Kunststoff Matière plastique Kunststoff



☞ Schwarz Noir Zwart

**incl. 4x0,275 W**

20.000 K

DC 12 V

EAN 4000870 987728

**987.72**



## Downlights | Floor

Bodeneinbauleuchten für Innen und Außen. Mehrere Einbauleuchten im Boden sorgen für Orientierung in der Dunkelheit. Ideal für die Inszenierung und Abgrenzung von Bereichen im und außen vor dem Haus.

Encastrés sol pour l'intérieur et l'extérieur. Plusieurs encastrés installés dans le sol permettent une bonne orientation dans l'obscurité. Idéal pour la mise en scène et la délimitation d'espaces à l'intérieur comme à l'extérieur de la maison.

Bodeminbouwlampen voor binnen en buiten. Meerdere inbouwlampen in de bodem zorgen voor oriëntatie in het donker. Ideaal voor de verlichting en afbakening van ruimtes binnen en buiten het huis.

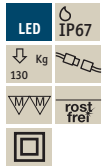
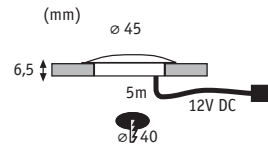

**LED Allround**

☒ Kunststoff/Edelstahl Matière plastique/Acier inoxydable Kunststoff/edelstaal

- ▶ Staubdicht und wasserdicht bei zeitweiligem Untertauchen (IP67)
- ▶ Als Einbautiefe reicht die Parkettstärke
- ▶ Protection contre la poussière et l'immersion temporaire (IP67)
- ▶ L'épaisseur du parquet suffit comme profondeur d'encastrement
- ▶ Stofdicht en waterdicht bij tijdelijke onderdompeling (IP67)
- ▶ Als inbouwdiepte is de dikte van het parket voldoende



☞ Transparent Transparente Transparant

**incl. 1×0,7 W**

48 lm, 4.000 K

∠ 100°

DC 12 V

EAN 4000870 938270

**938.27**

A++-A

**incl. 3×0,7 W**

3×48 lm, 4.000 K

∠ 100°

230/12 V, incl. ⚡ 3,6 VA

EAN 4000870 938287

**938.28**

A++-A



☞ Satin Satiné Satijn

**incl. 1×0,7 W**

32 lm, 2.700 K

∠ 110°

DC 12 V

EAN 4000870 938294

**938.29**

A++-A

**incl. 3×0,7 W**

3×32 lm, 2.700 K

∠ 110°

230/12 V, incl. ⚡ 3,6 VA

EAN 4000870 938300

**938.30**

A++-A

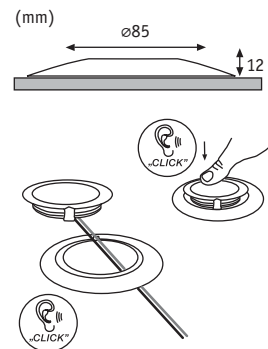

**Allround Mounting ring round**

☒ Edelstahl Acier inoxydable edelstaal

- ▶ Aufbauiring zur Installation auf z.B. Stein, Beton, Teppich
- ▶ Socle plat pour montage sur pierre, béton, moquette par ex.
- ▶ Opbouwring voor de installatie op bijv. steen, beton, vloerbedekking



☞ Edelstahl Acier inoxydable Edelstaal

EAN 4000870 938317

**938.31**

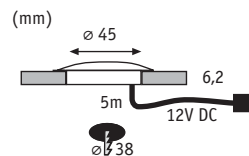

LED IP67  
 130 Kg  
 Polycarbonat rostfrei

Focus Energy Silber 2006

**UpDownlight**

Polycarbonat Polycarbonate Polycarbonaat

- ▶ Staubdicht und wasserdicht bei zeitweiligem Untertauchen (IP67)
- ▶ Als Einbautiefe reicht die Parkettstärke
- ▶ Protection contre la poussière et l'immersion temporaire (IP67)
- ▶ L'épaisseur du parquet suffit comme profondeur d'encastrement
- ▶ Stofdicht en waterdicht bij tijdelijke onderdompeling (IP67)
- ▶ Als inbouwdiepte is de dikte van het parket voldoende

Satin Satiné Satijn



**incl. 1x1 W**  
 6.500 K  
 ∠ 120°, 13 cd  
 DC 12 V  
 EAN 4000870 987568  
**987.56**



**incl. 1x1 W**  
 3.000 K  
 ∠ 120°, 13 cd  
 DC 12 V  
 EAN 4000870 937006  
**937.00**

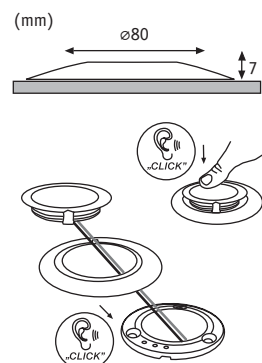

Alu rostfrei

**UpDownlight Mounting ring round**

Alu Zink Alu zinc Alu zink

- ▶ Aufbauring zur Installation auf z.B. Stein, Beton, Teppich
- ▶ Sockle plat pour montage sur pierre, béton, moquette par ex.
- ▶ Opbouwring voor de installatie op bijv. steen, beton, vloerbedekking



Chrom matt Chrome mat Chroom mat  
 EAN 4000870 987773  
**987.77**



Eisen gebürstet Acier brossé Staal geborsteld  
 EAN 4000870 987810  
**987.81**



## Downlights | Ceiling

Deckeneinbauleuchten für moderne Raumbeleuchtung.  
Einbauleuchten geben pures Licht bei gleichzeitig dezenter visueller Präsenz der Leuchte. Ob als Grundbeleuchtung oder zur Akzentuierung eingesetzt, sind sie ebenso dekorative wie praktische Lichtquellen.

Encastrés pour plafonds pour un éclairage d'ambiance moderne. Les encastrés vous donnent une vraie lumière tout en faisant visuellement disparaître le luminaire. Comme éclairage de base ou pour une mise en valeur, ces sources lumineuses allient effet décoratif et côté pratique. Plafondinbouwlampen voor moderne ruimteverlichting.

Inbouwlampen zorgen voor puur licht bij een onopvallende visuele aanwezigheid van de armaturen. Of ze nu als basisverlichting of voor lichtaccenten worden ingezet, het zijn zowel decoratieve als praktische lichtbronnen. Recessed ceiling luminaires for modern room lighting.



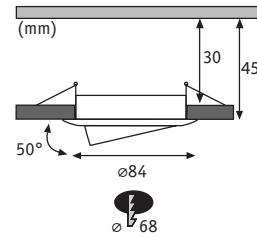

939.48

LED □= 415-450

### Reflector Coin dimmable 230V

Alu Zink Alu zinc Alu zink

- ▶ Geringe Mindesteinbautiefe
- ▶ Mit Schutzglas
- ▶ Inkl. Anschlussbox mit Doppelschnellklemme zum Durchschleifen
- ▶ Faible profondeur d'encastrement
- ▶ Avec verre de protection
- ▶ Boîte raccord avec double clip de fixation rapide pour la connexion du câble incluse
- ▶ Geringe minimale inbouwdiepte
- ▶ Met beveiligingsglas
- ▶ Inclusief aansluitbox met dubbele snelklem voor aankoppeling van de kabel



☞ Eisen gebürstet Acier brossé Staal geborsteld

**incl. 1×6,8 W, A<sup>+</sup> A<sup>++</sup>-A**

544 lm, 2.700 K

∠ 38°

230 V

EAN 4000870 939475

**939.47**

**incl. 3×6,8 W, A<sup>+</sup> A<sup>++</sup>-A**

3×544 lm, 2.700 K

∠ 38°

230 V

EAN 4000870 939444

**939.44**



☞ Weiß/Chrom Blanc/Chrome Wit/Chroom

**incl. 1×6,8 W, A<sup>+</sup> A<sup>++</sup>-A**

544 lm, 2.700 K

∠ 38°

230 V

EAN 4000870 939451

**939.45**

**incl. 3×6,8 W, A<sup>+</sup> A<sup>++</sup>-A**

3×544 lm, 2.700 K

∠ 38°

230 V

EAN 4000870 939420

**939.42**



☞ Alu gedreht Alu tourné Alu gedraaid

**incl. 1×6,8 W, A<sup>+</sup> A<sup>++</sup>-A**

544 lm, 2.700 K

∠ 38°

230 V

EAN 4000870 939468

**939.46**

**incl. 3×6,8 W, A<sup>+</sup> A<sup>++</sup>-A**

3×544 lm, 2.700 K

∠ 38°

230 V

EAN 4000870 939437

**939.43**

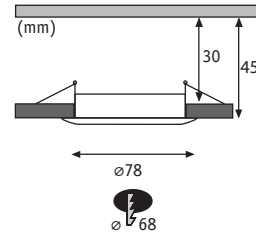

938.84

LED □= 415-450

### Premium LED 230V Slim Coin Satin 51mm

Alu Zink Alu zinc Alu zink

- ▶ Geringe Mindesteinbautiefe
- ▶ Mit Schutzglas
- ▶ Inkl. Anschlussbox mit Doppelschnellklemme zum Durchschleifen
- ▶ Faible profondeur d'encastrement
- ▶ Avec verre de protection
- ▶ Boîte raccord avec double clip de fixation rapide pour la connexion du câble incluse
- ▶ Geringe minimale inbouwdiepte
- ▶ Met beveiligingsglas
- ▶ Inclusief aansluitbox met dubbele snelklem voor aankoppeling van de kabel



Wei matt Blanc dpoli Wit mat

**incl. 1×6,8 W** <A++-A

592 lm, 2.700 K

230 V

EAN 4000870 938577

**938.57**

**incl. 3×6,8 W** <A++-A

3×592 lm, 2.700 K

230 V

EAN 4000870 938584

**938.58**



Eisen gebrstet Acier bross Staal geborsteld

**incl. 1×6,8 W** <A++-A

592 lm, 2.700 K

230 V

EAN 4000870 938591

**938.59**

**incl. 3×6,8 W** <A++-A

3×592 lm, 2.700 K

230 V

EAN 4000870 938607

**938.60**



Chrom Chrome Chrom

**incl. 1×6,8 W** <A++-A

592 lm, 2.700 K

230 V

EAN 4000870 938614

**938.61**

**incl. 3×6,8 W** <A++-A

3×592 lm, 2.700 K

230 V

EAN 4000870 938621

**938.62**



Alu gedreht Alu tourn Alu gedraaid

**incl. 1×6,8 W** <A++-A

592 lm, 2.700 K

230 V

EAN 4000870 938966

**938.96**

**incl. 3×6,8 W** <A++-A

3×592 lm, 2.700 K

230 V

EAN 4000870 938973

**938.97**

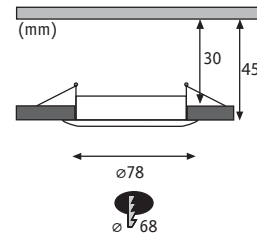

938.85

LED □= 415-450

### Premium LED 230V Slim Coin Satin 51mm dimmable

Alu Zink Alu zinc Alu zink

- ▶ Geringe Mindesteinbautiefe
- ▶ Mit Schutzglas
- ▶ Inkl. Anschlussbox mit Doppelschnellklemme zum Durchschleifen
- ▶ Faible profondeur d'encastrement
- ▶ Avec verre de protection
- ▶ Boîte raccord avec double clip de fixation rapide pour la connexion du câble incluse
- ▶ Geringe minimale inbouwdiepte
- ▶ Met beveiligingsglas
- ▶ Inclusief aansluitbox met dubbele snelklem voor aankoppeling van de kabel



Wei matt Blanc dpoli Wit mat

**incl. 1×6,8 W** <A++-A

633 lm, 2.700 K

230 V

EAN 4000870 938690

**938.69**

**incl. 3×6,8 W** <A++-A

3×633 lm, 2.700 K

230 V

EAN 4000870 938706

**938.70**



Eisen gebrstet Acier bross Staal geborsteld

**incl. 1×6,8 W** <A++-A

633 lm, 2.700 K

230 V

EAN 4000870 938713

**938.71**

**incl. 3×6,8 W** <A++-A

3×633 lm, 2.700 K

230 V

EAN 4000870 938737

**938.73**



Chrom Chrome Chrom

**incl. 1×6,8 W** <A++-A

633 lm, 2.700 K

230 V

EAN 4000870 938720

**938.72**

**incl. 3×6,8 W** <A++-A

3×633 lm, 2.700 K

230 V

EAN 4000870 938744

**938.74**



Alu gedreht Alu tourn Alu gedraaid

**incl. 1×6,8 W** <A++-A

633 lm, 2.700 K

230 V

EAN 4000870 939000

**939.00**

**incl. 3×6,8 W** <A++-A

3×633 lm, 2.700 K

230 V

EAN 4000870 939017

**939.01**

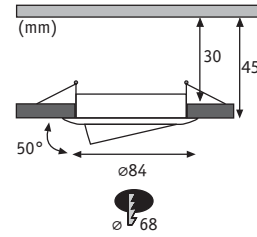

938.84

LED □= 415-450

### Premium LED 230V Slim Coin Satin 51mm

Alu Zink Alu zinc Alu zink

- ▶ Geringe Mindesteinbautiefe
- ▶ Mit Schutzglas
- ▶ Inkl. Anschlussbox mit Doppelschnellklemme zum Durchschleifen
- ▶ Faible profondeur d'encastrement
- ▶ Avec verre de protection
- ▶ Boîte raccord avec double clip de fixation rapide pour la connexion du câble incluse
- ▶ Geringe minimale inbouwdiepte
- ▶ Met beveiligingsglas
- ▶ Inclusief aansluitbox met dubbele snelklem voor aankoppeling van de kabel



Wei matt Blanc dpoli Wit mat

**incl. 1×6,8 W** <A++-A  
592 lm, 2.700 K  
230 V  
EAN 4000870 938638  
**938.63**

**incl. 3×6,8 W** <A++-A  
3×592 lm, 2.700 K  
230 V  
EAN 4000870 938645  
**938.64**



Eisen gebrstet Acier bross Staal geborsteld

**incl. 1×6,8 W** <A++-A  
592 lm, 2.700 K  
230 V  
EAN 4000870 938669  
**938.66**

**incl. 3×6,8 W** <A++-A  
3×592 lm, 2.700 K  
230 V  
EAN 4000870 938652  
**938.65**



Chrom Chrome Chrom

**incl. 1×6,8 W** <A++-A  
592 lm, 2.700 K  
230 V  
EAN 4000870 938676  
**938.67**

**incl. 3×6,8 W** <A++-A  
3×592 lm, 2.700 K  
230 V  
EAN 4000870 938683  
**938.68**



Alu gedreht Alu tourn Alu gedraaid

**incl. 1×6,8 W** <A++-A  
592 lm, 2.700 K  
230 V  
EAN 4000870 938980  
**938.98**

**incl. 3×6,8 W** <A++-A  
3×592 lm, 2.700 K  
230 V  
EAN 4000870 938997  
**938.99**

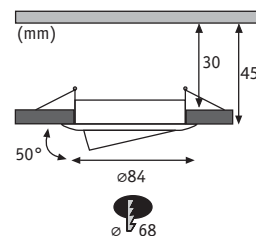

938.85

LED □= 415-450

### Premium LED 230V Slim Coin Satin 51mm dimmable

Alu Zink Alu zinc Alu zink

- ▶ Geringe Mindesteinbautiefe
- ▶ Mit Schutzglas
- ▶ Inkl. Anschlussbox mit Doppelschnellklemme zum Durchschleifen
- ▶ Faible profondeur d'encastrement
- ▶ Avec verre de protection
- ▶ Boîte raccord avec double clip de fixation rapide pour la connexion du câble incluse
- ▶ Geringe minimale inbouwdiepte
- ▶ Met beveiligingsglas
- ▶ Inclusief aansluitbox met dubbele snelklem voor aankoppeling van de kabel



Wei matt Blanc dpoli Wit mat

**incl. 1x6,8 W** <A++-A

633 lm, 2.700 K

230 V

EAN 4000870 938768

**938.76**

**incl. 3x6,8 W** <A++-A

3x633 lm, 2.700 K

230 V

EAN 4000870 938751

**938.75**



Eisen gebrstet Acier bross Staal geborsteld

**incl. 1x6,8 W** <A++-A

633 lm, 2.700 K

230 V

EAN 4000870 938775

**938.77**

**incl. 3x6,8 W** <A++-A

3x633 lm, 2.700 K

∠ 120°

230 V

EAN 4000870 938782

**938.78**



Chrom Chrome Chrom

**incl. 1x6,8 W** <A++-A

633 lm, 2.700 K

230 V

EAN 4000870 938799

**938.79**

**incl. 3x6,8 W** <A++-A

3x633 lm, 2.700 K

230 V

EAN 4000870 938805

**938.80**



Alu gedreht Alu tourn Alu gedraaid

**incl. 1x6,8 W** <A++-A

633 lm, 2.700 K

∠ 120°

230 V

EAN 4000870 939024

**939.02**

**incl. 3x6,8 W** <A++-A

3x633 lm, 2.700 K

230 V

EAN 4000870 939031

**939.03**

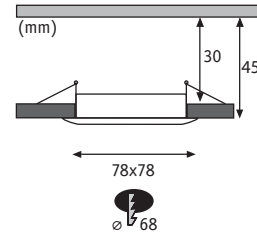

938.85

LED □= 415-450

### Premium LED 230V Slim Coin Satin 51mm dimmable

Alu Zink Alu zinc Alu zink

- ▶ Geringe Mindesteinbautiefe
- ▶ Mit Schutzglas
- ▶ Inkl. Anschlussbox mit Doppelschnellklemme zum Durchschleifen
- ▶ Faible profondeur d'encastrement
- ▶ Avec verre de protection
- ▶ Boîte raccord avec double clip de fixation rapide pour la connexion du câble incluse
- ▶ Geringe minimale inbouwdiepte
- ▶ Met beveiligingsglas
- ▶ Inclusief aansluitbox met dubbele snelklem voor aankoppeling van de kabel



Wei matt Blanc dpoli Wit mat

**incl. 1x6,8 W**

A<sup>++</sup>-A

633 lm, 2.700 K

230 V

EAN 4000870 938881

**938.88**

**incl. 3x6,8 W**

A<sup>++</sup>-A

3x633 lm, 2.700 K

230 V

EAN 4000870 938898

**938.89**



Eisen gebrstet Acier bross Staal geborsteld

**incl. 1x6,8 W**

A<sup>++</sup>-A

633 lm, 2.700 K

230 V

EAN 4000870 938911

**938.91**

**incl. 3x6,8 W**

A<sup>++</sup>-A

3x633 lm, 2.700 K

230 V

EAN 4000870 938904

**938.90**



Alu gedreht Alu tourn Alu gedraaid

**incl. 1x6,8 W**

A<sup>++</sup>-A

633 lm, 2.700 K

230 V

EAN 4000870 938942

**938.94**

**incl. 3x6,8 W**

A<sup>++</sup>-A

3x633 lm, 2.700 K

230 V

EAN 4000870 938959

**938.95**

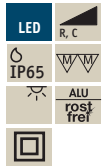
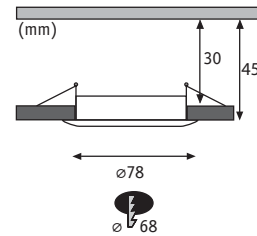

938.85

LED □= 415-450

**Premium LED IP65 230V Slim Coin Satin 51mm dimmable**

Alu Zink Alu zinc Alu zink

- ▶ Geringe Mindesteinbautiefe
- ▶ Mit Schutzglas
- ▶ Inkl. Anschlussbox mit Doppelschnellklemme zum Durchschleifen
- ▶ Faible profondeur d'encastrement
- ▶ Avec verre de protection
- ▶ Boîte raccord avec double clip de fixation rapide pour la connexion du câble incluse
- ▶ Geringe minimale inbouwdiepte
- ▶ Met beveiligingsglas
- ▶ Inclusief aansluitbox met dubbele snelklem voor aankoppeling van de kabel



Wei matt Blanc dpoli Wit mat

**incl. 1x6,8 W** A++-A

633 lm, 2.700 K

230 V

EAN 4000870 938812

**938.81**



Eisen gebrstet Acier bross Staal geborsteld

**incl. 1x6,8 W** A++-A

633 lm, 2.700 K

230 V

EAN 4000870 938829

**938.82**



Chrom Chrome Chroom

**incl. 1x6,8 W** A++-A

633 lm, 2.700 K

230 V

EAN 4000870 938836

**938.83**

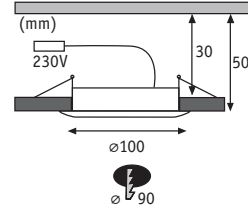

**Premium Line LED 230V Coin 75mm**

Alu Zink Alu zinc Alu zink

- ▶ Geringe Mindesteinbautiefe
- ▶ Mit Schutzglas
- ▶ Inkl. Anschlussbox mit Doppelschnellklemme zum Durchschleifen
- ▶ Faible profondeur d'encastrement
- ▶ Avec verre de protection
- ▶ Boîte raccord avec double clip de fixation rapide pour la connexion du câble incluse
- ▶ Geringe minimale inbouwdiepte
- ▶ Met beveiligingsglas
- ▶ Inclusief aansluitbox met dubbele snelklem voor aankoppeling van de kabel



Wei matt/Satin Blanc dpoli/Satin Wit mat/Satijn

**incl. 1x14 W,** A A+-A

830 lm, 2.700 K  
 x 110°  
 230 V  
 EAN 4000870 927861  
**927.86**



Eisen gebrstet/Satin Acier bross/Satin Staal geborsteld/Satijn

**incl. 1x14 W,** A A+-A

830 lm, 2.700 K  
 x 110°  
 230 V  
 EAN 4000870 927878  
**927.87**



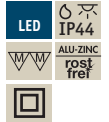
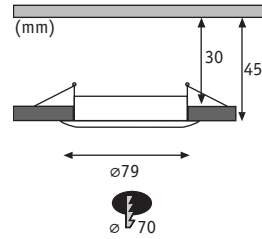

938.19

LED □= 415-450

### LED 230V Coin 51mm

Alu Zink Alu zinc Alu zink

► Geringe Einbautiefe

► Profondeur d'encastrement réduite

► Geringe inbouwdiepte



Wei matt/Satin Blanc dpoli/Satin Wit mat/Satijn

**incl. 1×6,8 W, A<sup>+</sup> A<sup>++</sup>-A**

535 lm, 2.700 K

∠ 160°

230 V

EAN 4000870 939734

**939.73**

**incl. 3×6,8 W, A<sup>+</sup> A<sup>++</sup>-A**

3×535 lm, 2.700 K

∠ 160°

230 V

EAN 4000870 939741

**939.74**



Eisen gebrstet/Satin Acier bross/Satin Staal geborsteld/Satijn

**incl. 1×6,8 W, A<sup>+</sup> A<sup>++</sup>-A**

535 lm, 2.700 K

∠ 160°

230 V

EAN 4000870 939758

**939.75**

**incl. 3×6,8 W, A<sup>+</sup> A<sup>++</sup>-A**

3×535 lm, 2.700 K

∠ 160°

230 V

EAN 4000870 939765

**939.76**

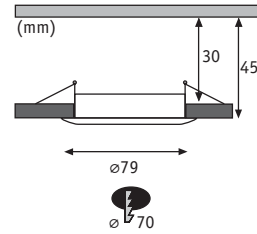

938.36  
LED □= 415-450

LED 230V Coin 51mm dimmable

Alu Zink Alu zinc Alu zink



Weiß matt/Satin Blanc dépoli/Satiné Wit mat/Satijn

**incl. 1×7 W, A** < A'-A

482 lm, 2.700 K  
∠ 105°  
230 V  
EAN 4000870 939550  
**939.55**

**incl. 3×7 W, A** < A'-A

3×482 lm, 2.700 K  
∠ 105°  
230 V  
EAN 4000870 939567  
**939.56**



Eisen gebürstet/Satin Acier brossé/Satiné Staal geborsteld/Satijn

**incl. 1×7 W, A** < A'-A

482 lm, 2.700 K  
∠ 105°  
230 V  
EAN 4000870 939574  
**939.57**

**incl. 3×7 W, A** < A'-A

3×482 lm, 2.700 K  
∠ 105°  
230 V  
EAN 4000870 939581  
**939.58**



Chrom/Satin Chrome/Satiné Chroom/Satijn

**incl. 1×7 W, A** < A'-A

482 lm, 2.700 K  
∠ 105°  
230 V  
EAN 4000870 939598  
**939.59**

**incl. 3×7 W, A** < A'-A

3×482 lm, 2.700 K  
∠ 105°  
230 V  
EAN 4000870 939604  
**939.60**

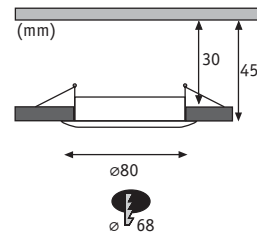

938.36  
LED □= 415-450

LED 230V Coin 51mm dimmable

Alu Alu Alu



Alu gedreht/Satin Alu tourné/Satiné Alu gedraaid/Satijn

**incl. 1×7 W, A** < A'-A

482 lm, 2.700 K  
∠ 105°  
230 V  
EAN 4000870 939673  
**939.67**

**incl. 3×7 W, A** < A'-A

3×482 lm, 2.700 K  
∠ 105°  
230 V  
EAN 4000870 939680  
**939.68**

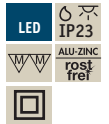
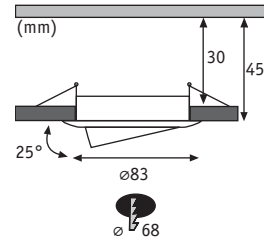

938.19

LED □= 415-450

LED 230V Coin 51mm

Alu Zink Alu zinc Alu zink



Wei matt/Satin Blanc dpoli/Satin Wit mat/Satijn

**incl. 1×6,8 W, A<sup>+</sup> A<sup>++</sup>-A**

535 lm, 2.700 K

∠ 160°

230 V

EAN 4000870 939772

**939.77**

**incl. 3×6,8 W, A<sup>+</sup> A<sup>++</sup>-A**

3×535 lm, 2.700 K

∠ 160°

230 V

EAN 4000870 939789

**939.78**



Eisen gebrstet/Satin Acier bross/Satin Staal geborsteld/Satijn

**incl. 1×6,8 W, A<sup>+</sup> A<sup>++</sup>-A**

535 lm, 2.700 K

∠ 160°

230 V

EAN 4000870 939796

**939.79**

**incl. 3×6,8 W, A<sup>+</sup> A<sup>++</sup>-A**

3×535 lm, 2.700 K

∠ 160°

230 V

EAN 4000870 939802

**939.80**



Chrom/Satin Chrome/Satin Chroom/Satijn

**incl. 1×6,8 W, A<sup>+</sup> A<sup>++</sup>-A**

535 lm, 2.700 K

∠ 160°

230 V

EAN 4000870 939819

**939.81**

**incl. 3×6,8 W, A<sup>+</sup> A<sup>++</sup>-A**

3×535 lm, 2.700 K

∠ 160°

230 V

EAN 4000870 939826

**939.82**

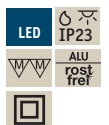
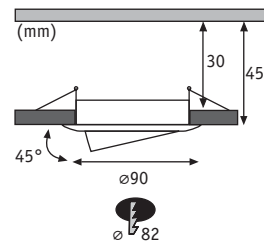

938.19

LED □= 415-450

LED 230V Coin 51mm

Alu Alu Alu



Alu gedreht/Satin Alu tourn/Satin Alu gedraaid/Satijn

**incl. 1×6,8 W, A<sup>+</sup> A<sup>++</sup>-A**

535 lm, 2.700 K

∠ 160°

230 V

EAN 4000870 939833

**939.83**

**incl. 3×6,8 W, A<sup>+</sup> A<sup>++</sup>-A**

3×535 lm, 2.700 K

∠ 160°

230 V

EAN 4000870 939840

**939.84**

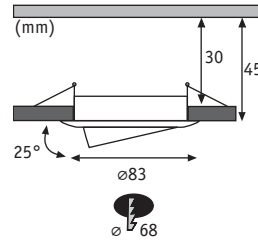

938.36  
LED □= 415-450

LED 230V Coin 51mm dimmable

Alu Zink Alu zinc Alu zink



Wei matt/Satin Blanc dpoli/Satin Wit mat/Satijn

**incl. 1x7 W, A** < A+-A

482 lm, 2.700 K  
∠ 105°  
230 V  
EAN 4000870 939611  
**939.61**

**incl. 3x7 W, A** < A+-A

3x482 lm, 2.700 K  
∠ 105°  
230 V  
EAN 4000870 939628  
**939.62**



Eisen gebrstet/Satin Acier bross/Satin Staal geborsteld/Satijn

**incl. 1x7 W, A** < A+-A

482 lm, 2.700 K  
∠ 105°  
230 V  
EAN 4000870 939635  
**939.63**

**incl. 3x7 W, A** < A+-A

3x482 lm, 2.700 K  
∠ 105°  
230 V  
EAN 4000870 939642  
**939.64**



Chrom/Satin Chrome/Satin Chroom/Satijn

**incl. 1x7 W, A** < A+-A

482 lm, 2.700 K  
∠ 105°  
230 V  
EAN 4000870 939659  
**939.65**

**incl. 3x7 W, A** < A+-A

3x482 lm, 2.700 K  
∠ 105°  
230 V  
EAN 4000870 939666  
**939.66**

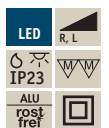
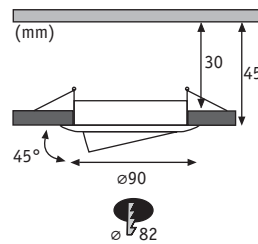

938.36  
LED □= 415-450

LED 230V Coin 51mm dimmable

Alu Alu Alu



Alu gedreht/Satin Alu tourn/Satin Alu gedraaid/Satijn

**incl. 1x7 W, A** < A+-A

482 lm, 2.700 K  
∠ 105°  
230 V  
EAN 4000870 939697  
**939.69**

**incl. 3x7 W, A** < A+-A

3x482 lm, 2.700 K  
∠ 105°  
230 V  
EAN 4000870 939703  
**939.70**

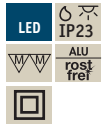
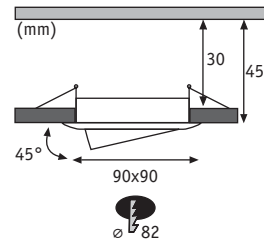

938.19

LED □= 415-450

LED 230V Coin 51mm

Alu Alu Alu



Alu gedreht/Satin Alu tourné/Satiné Alu gedraaid/Satijn

**incl. 1×6,8 W, A<sup>+</sup>** < A<sup>++</sup>-A

535 lm, 2.700 K

∠ 160°

230 V

EAN 4000870 939857

**939.85**

**incl. 3×6,8 W, A<sup>+</sup>** < A<sup>++</sup>-A

3×535 lm, 2.700 K

∠ 160°

230 V

EAN 4000870 939864

**939.86**

000

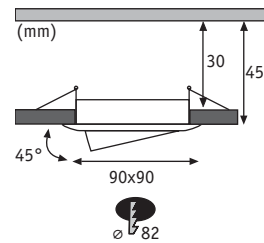

938.36

LED □= 415-450

LED 230V Coin 51mm dimmable

Alu Alu Alu



Alu gedreht/Satin Alu tourné/Satiné Alu gedraaid/Satijn

**incl. 1×7 W, A** < A<sup>++</sup>-A

482 lm, 2.700 K

∠ 105°

230 V

EAN 4000870 939710

**939.71**

**incl. 3×7 W, A** < A<sup>++</sup>-A

3×482 lm, 2.700 K

∠ 105°

230 V

EAN 4000870 939727

**939.72**

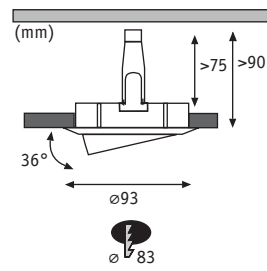

GU10  
LED □= 415-450

**Premium Nova IP65 adjustable GU10 dimmable**    Alu Zink Alu zinc Alu zink



Weiß matt Blanc dépoli Wit mat

**incl. 1x7 W, A+** < A++-E  
460 lm, 2.700 K  
230 V  
EAN 4000870 928974  
**928.97**

**incl. 3x7 W, A+** < A++-E  
3x460 lm, 2.700 K  
230 V  
EAN 4000870 928981  
**928.98**



Eisen gebürstet Acier brossé Staal geborsteld

**incl. 1x7 W, A+** < A++-E  
460 lm, 2.700 K  
230 V  
EAN 4000870 928998  
**928.99**

**incl. 3x7 W, A+** < A++-E  
3x460 lm, 2.700 K  
230 V  
EAN 4000870 929001  
**929.00**

000

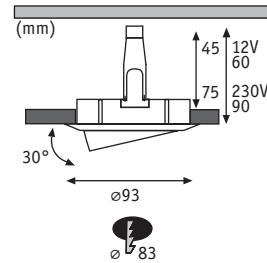

GU5,3 / GU10  
LED □= 415-450  
12V □= 457-460

**Premium Nova IP65 adjustable GU10/GU5,3**    Alu Zink Alu zinc Alu zink



Weiß matt Blanc dépoli Wit mat

**max. 35 W** < A++-E  
EAN 4000870 936610  
**936.61**



Eisen gebürstet Acier brossé Staal geborsteld

**max. 35 W** < A++-E  
EAN 4000870 936627  
**936.62**

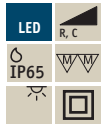
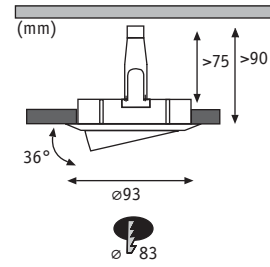

GU10  
LED □= 415-450

**Premium Nova IP65 adjustable GU10 dimmable**

Alu Zink Alu zinc Alu zink



Weiß matt/Chrom Blanc dépoli/Chrome Wit mat/Chroom

incl. 1x7 W, A+ A++-E

460 lm, 2.700 K

230 V

EAN 4000870 929032

929.03

000

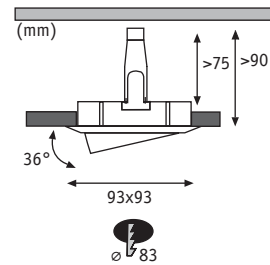

GU10  
LED □= 415-450

**Premium Nova IP65 adjustable GU10 dimmable**

Alu Zink Alu zinc Alu zink



Weiß matt/Chrom Blanc dépoli/Chrome Wit mat/Chroom

incl. 1x7 W, A+ A++-E

460 lm, 2.700 K

230 V

EAN 4000870 929049

929.04

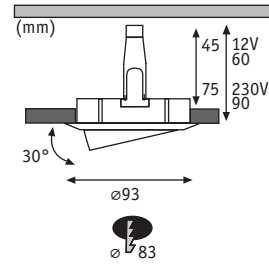

GU5,3 / GU10  
**LED** □= 415-450  
**12V** □= 457-460

**Premium Nova IP65 adjustable GU10/GU5,3** □ Alu Zink Alu zinc Alu zink

- ▶ Spritz- und Strahlwassergeschützt (IP65)
- ▶ Geeignet für die Installation im Bad
- ▶ Protection contre les projections d'eau et les jets d'eau (IP65)
- ▶ Convient à l'installation dans des salles de bains
- ▶ Beschermtd tegen opspattend water en waterstralen (IP65)
- ▶ Geschikt voor installatie in de badkamer



☞ Weiß matt/Chrom Blanc dépoli/Chrome Wit mat/Chroom

**max. 35 W** ◀ A++-E  
 EAN 4000870 936634  
**936.63**

000

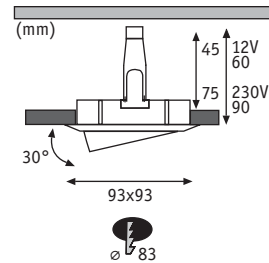

GU5,3 / GU10  
**LED** □= 415-450  
**12V** □= 457-460

**Premium Nova IP65 adjustable GU10/GU5,3** □ Alu Zink Alu zinc Alu zink

- ▶ Spritz- und Strahlwassergeschützt (IP65)
- ▶ Geeignet für die Installation im Bad
- ▶ Protection contre les projections d'eau et les jets d'eau (IP65)
- ▶ Convient à l'installation dans des salles de bains
- ▶ Beschermtd tegen opspattend water en waterstralen (IP65)
- ▶ Geschikt voor installatie in de badkamer



☞ Weiß matt/Chrom Blanc dépoli/Chrome Wit mat/Chroom

**max. 35 W** ◀ A++-E  
 EAN 4000870 936641  
**936.64**



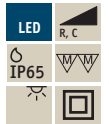
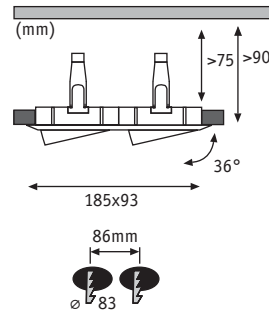

GU10  
LED □= 415-450

### Premium Nova IP65 adjustable GU10 dimmable

Alu Zink Alu zinc Alu zink

- ▶ Spritz- und Strahlwassergeschützt (IP65)
- ▶ Geeignet für die Installation im Bad
- ▶ Protection contre les projections d'eau et les jets d'eau (IP65)
- ▶ Convient à l'installation dans des salles de bains
- ▶ Beschermtd tegen opspattend water en waterstralen (IP65)
- ▶ Geschikt voor installatie in de badkamer



Wei matt/Chrom Blanc dpoli/Chrome Wit mat/Chroom

incl. 1x (2x7 W), A+ A+-E  
1x 2x460 lm, 2.700 K  
230 V  
EAN 4000870 929018  
**929.01**

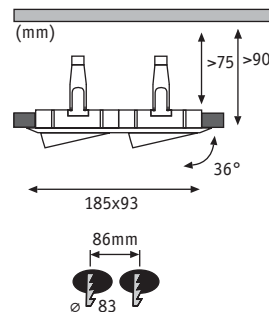

GU10  
LED □= 415-450

### Premium Nova IP65 adjustable GU10 dimmable

Alu Zink Alu zinc Alu zink

- ▶ Spritz- und Strahlwassergeschützt (IP65)
- ▶ Geeignet für die Installation im Bad
- ▶ Protection contre les projections d'eau et les jets d'eau (IP65)
- ▶ Convient à l'installation dans des salles de bains
- ▶ Beschermtd tegen opspattend water en waterstralen (IP65)
- ▶ Geschikt voor installatie in de badkamer



Wei matt/Chrom Blanc dpoli/Chrome Wit mat/Chroom

incl. 1x (2x7 W), A+ A+-E  
1x 2x460 lm, 2.700 K  
230 V  
EAN 4000870 929025  
**929.02**

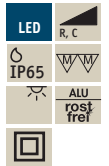
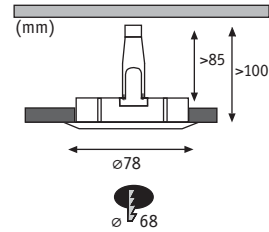

GU10  
LED  $\square$  = 415-450

**Premium LED Nova IP65 230V GU10 51mm dimmable**

Alu Zink Alu zinc Alu zink

- ▶ Spritz- und Strahlwassergeschützt (IP65)
- ▶ Geeignet für die Installation im Bad
- ▶ Protection contre les projections d'eau et les jets d'eau (IP65)
- ▶ Convient à l'installation dans des salles de bains
- ▶ Beschermtd tegen opspattend water en waterstralen (IP65)
- ▶ Geschikt voor installatie in de badkamer



Weiß matt Blanc dépoli Wit mat

**incl. 1x7W,  $\triangleleft$  A<sup>+</sup>  $\triangleleft$  A<sup>++</sup>-E**  
460 lm, 2.700 K  
230 V  
EAN 4000870 936252  
**936.25**



Eisen gebürstet Acier brossé Staal geborsteld

**incl. 1x7W,  $\triangleleft$  A<sup>+</sup>  $\triangleleft$  A<sup>++</sup>-E**  
460 lm, 2.700 K  
230 V  
EAN 4000870 936269  
**936.26**



Chrom Chrome Chroom

**incl. 1x7W,  $\triangleleft$  A<sup>+</sup>  $\triangleleft$  A<sup>++</sup>-E**  
460 lm, 2.700 K  
230 V  
EAN 4000870 936276  
**936.27**

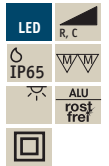
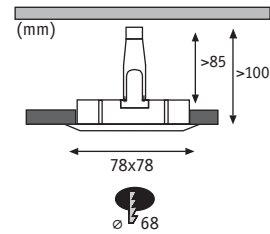
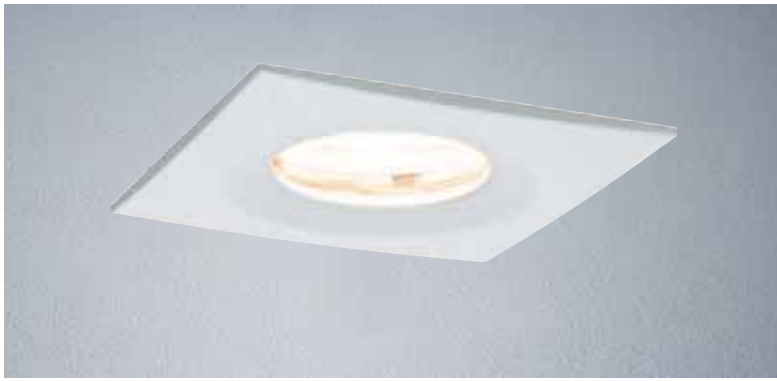

GU10  
LED □= 415-450

**Premium LED Nova IP65 230V GU10 51mm dimmable**

Alu Zink Alu zinc Alu zink

- ▶ Spritz- und Strahlwassergeschützt (IP65)
- ▶ Geeignet für die Installation im Bad
- ▶ Protection contre les projections d'eau et les jets d'eau (IP65)
- ▶ Convient à l'installation dans des salles de bains
- ▶ Beschermtd tegen opspattend water en waterstralen (IP65)
- ▶ Geschikt voor installatie in de badkamer



Wei matt Blanc dpoli Wit mat

**incl. 1x7W, A+** A++-E

460 lm, 2.700 K  
230 V  
EAN 4000870 936283  
**936.28**



Eisen gebrstet Acier bross Staal geborsteld

**incl. 1x7W, A+** A++-E

460 lm, 2.700 K  
230 V  
EAN 4000870 936290  
**936.29**



Chrom Chrome Chroom

**incl. 1x7W, A+** A++-E

460 lm, 2.700 K  
230 V  
EAN 4000870 936306  
**936.30**

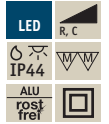
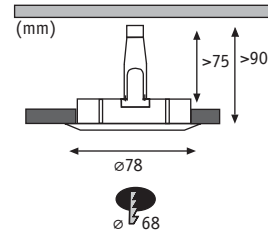

GU10  
LED □= 415-450

Premium LED Nova 230V GU10 51mm dimmable

Alu Zink Alu zinc Alu zink



Wei matt Blanc dpoli Wit mat

max. 35 W

A<sup>++</sup>-E

230 V  
EAN 4000870 936313  
**936.31**

incl. 1×7 W, A<sup>+</sup>

A<sup>++</sup>-E

460 lm, 2.700 K  
230 V  
EAN 4000870 935934  
**935.93**

incl. 3×7 W, A<sup>+</sup>

A<sup>++</sup>-E

3×460 lm, 2.700 K  
230 V  
EAN 4000870 935972  
**935.97**



Eisen gebrstet Acier bross Staal geborsteld

max. 35 W

A<sup>++</sup>-E

230 V  
EAN 4000870 936337  
**936.33**

incl. 1×7 W, A<sup>+</sup>

A<sup>++</sup>-E

460 lm, 2.700 K  
230 V  
EAN 4000870 935958  
**935.95**

incl. 3×7 W, A<sup>+</sup>

A<sup>++</sup>-E

3×460 lm, 2.700 K  
230 V  
EAN 4000870 935996  
**935.99**



Alu gedreht Alu tourn Alu gedraaid

max. 35 W

A<sup>++</sup>-E

230 V  
EAN 4000870 936320  
**936.32**

incl. 1×7 W, A<sup>+</sup>

A<sup>++</sup>-E

460 lm, 2.700 K  
230 V  
EAN 4000870 935941  
**935.94**

incl. 3×7 W, A<sup>+</sup>

A<sup>++</sup>-E

3×460 lm, 2.700 K  
230 V  
EAN 4000870 935989  
**935.98**

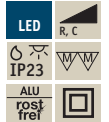
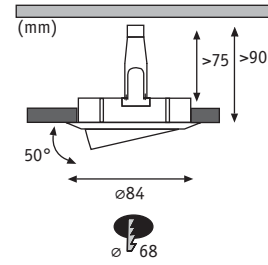

GU10  
LED □= 415-450

**Premium LED Nova 230V GU10 51mm dimmable**

Alu Zink Alu zinc Alu zink



Weiß matt Blanc dépoli Wit mat

**max. 35 W**

A<sup>++</sup>-E

230 V  
EAN 4000870 936399  
**936.39**

**incl. 1×7 W, A<sup>+</sup>**

A<sup>++</sup>-E

460 lm, 2.700 K  
230 V  
EAN 4000870 936016  
**936.01**

**incl. 3×7 W, A<sup>+</sup>**

A<sup>++</sup>-E

3×460 lm, 2.700 K  
230 V  
EAN 4000870 936054  
**936.05**



Eisen gebürstet Acier brossé Staal geborsteld

**max. 35 W**

A<sup>++</sup>-E

230 V  
EAN 4000870 936412  
**936.41**

**incl. 1×7 W, A<sup>+</sup>**

A<sup>++</sup>-E

460 lm, 2.700 K  
230 V  
EAN 4000870 936030  
**936.03**

**incl. 3×7 W, A<sup>+</sup>**

A<sup>++</sup>-E

3×460 lm, 2.700 K  
230 V  
EAN 4000870 936078  
**936.07**



Alu gedreht Alu tourné Alu gedraaid

**max. 35 W**

A<sup>++</sup>-E

230 V  
EAN 4000870 936405  
**936.40**

**incl. 1×7 W, A<sup>+</sup>**

A<sup>++</sup>-E

460 lm, 2.700 K  
230 V  
EAN 4000870 936023  
**936.02**

**incl. 3×7 W, A<sup>+</sup>**

A<sup>++</sup>-E

3×460 lm, 2.700 K  
230 V  
EAN 4000870 936061  
**936.06**

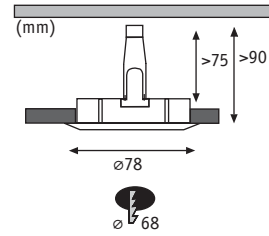

GU10  
LED □= 415-450

**Premium Nova 230V GU10 51mm**    Alu Zink Alu zinc Alu zink



Weiß matt Blanc dépoli Wit mat

**incl. 3×5,5 W, A<sup>+</sup> A<sup>++</sup>-E**

3×460 lm, 2.700 K  
230 V  
EAN 4000870 936535  
**936.53**



Eisen gebürstet Acier brossé Staal geborsteld

**incl. 3×5,5 W, A<sup>+</sup> A<sup>++</sup>-E**

3×460 lm, 2.700 K  
230 V  
EAN 4000870 936542  
**936.54**

000

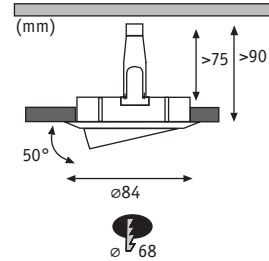

GU10  
LED □= 415-450

**Premium Nova adjustable 230V GU10 51mm**    Alu Zink Alu zinc Alu zink



Weiß matt Blanc dépoli Wit mat

**incl. 3×5,5 W, A<sup>+</sup> A<sup>++</sup>-E**

3×460 lm, 2.700 K  
230 V  
EAN 4000870 936511  
**936.51**



Eisen gebürstet Acier brossé Staal geborsteld

**incl. 3×5,5 W, A<sup>+</sup> A<sup>++</sup>-E**

3×460 lm, 2.700 K  
230 V  
EAN 4000870 936528  
**936.52**

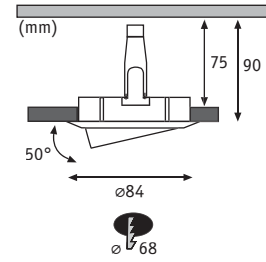

GU10  
LED  $\square$  = 415-450

**Premium Nova Warm Dim adjustable 230V GU10 51mm**  $\square$  Alu Zink Alu zinc Alu zink



$\mathcal{E}$  Eisen gebürstet Acier brossé Staal geborsteld

**incl. 3x5 W,  $\langle A^+ \rangle$**   $\langle A^{++} - E \rangle$

3x345 lm  
2.200 - 2.700 K  
230 V  
EAN 4000870 936498  
**936.49**

000

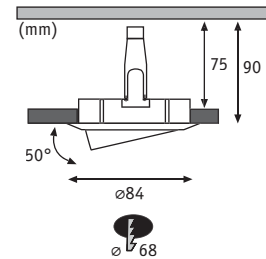

GU10  
LED  $\square$  = 415-450

**Premium Nova Warm Dim adjustable 230V GU10 51mm**  $\square$  Alu Zink Alu zinc Alu zink



$\mathcal{E}$  Weiß matt/Champagnergold matt Blanc dépoli/Doré champagne dépoli  
Wit mat/champagnegoud mat

**incl. 3x5 W,  $\langle A^+ \rangle$**   $\langle A^{++} - E \rangle$

3x345 lm  
2.200 - 2.700 K  
230 V  
EAN 4000870 936504  
**936.50**



Premium Line Drilled Alu dimmable

Alu Alu Alu



Alu gedreht Alu tourné Alu gedraaid

max. 40 W

A++-E

incl. 3×7 W, A+

A++-E

230 V

EAN 4000870 926284

926.28

3×460 lm, 2.700 K

230 V

EAN 4000870 929216

929.21

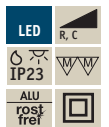
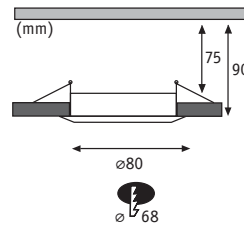

GU10

LED □= 415-450

Premium Line Drilled Alu dimmable

Alu Alu Alu



Alu gedreht Alu tourné Alu gedraaid

max. 40 W

A++-E

incl. 3×7 W, A+

A++-E

230 V

EAN 4000870 926253

926.25

3×460 lm, 2.700 K

230 V

EAN 4000870 929209

929.20

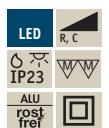
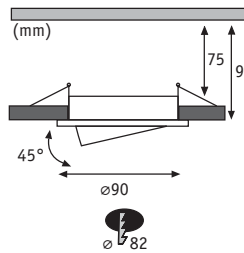

GU10

LED □= 415-450

Premium Line Drilled Alu dimmable

Alu Alu Alu



Alu gebürstet Alu brossé Alu geborsteld

max. 40 W

A++-E

incl. 3×7 W, A+

A++-E

230 V

EAN 4000870 926215

926.21

3×460 lm, 2.700 K

230 V

EAN 4000870 929193

929.19

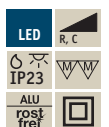
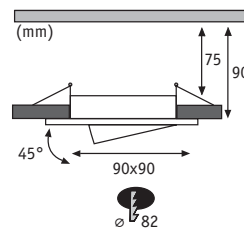

GU10

LED □= 415-450



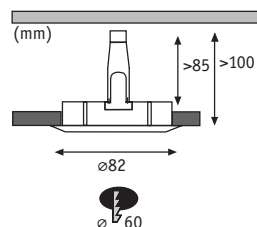

GU10  
LED □= 415-450

LED 230V GU10

Metall Métal Metaal



Weiß Blanc Wit

**incl. 1×4,5 W, A<sup>+</sup> A<sup>++</sup>-E**

340 lm, 2.700 K

230 V

EAN 4000870 936580

**936.58**

**incl. 3×4,5 W, A<sup>+</sup> A<sup>++</sup>-E**

3×340 lm, 2.700 K

230 V

EAN 4000870 936559

**936.55**



Eisen gebürstet Acier brossé Staal geborsteld

**incl. 1×4,5 W, A<sup>+</sup> A<sup>++</sup>-E**

340 lm, 2.700 K

230 V

EAN 4000870 936597

**936.59**

**incl. 3×4,5 W, A<sup>+</sup> A<sup>++</sup>-E**

3×340 lm, 2.700 K

230 V

EAN 4000870 936566

**936.56**



Chrom Chrome Chroom

**incl. 1×4,5 W, A<sup>+</sup> A<sup>++</sup>-E**

340 lm, 2.700 K

230 V

EAN 4000870 936603

**936.60**

**incl. 3×4,5 W, A<sup>+</sup> A<sup>++</sup>-E**

3×340 lm, 2.700 K

230 V

EAN 4000870 936573

**936.57**

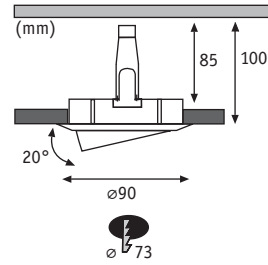

GU10  
LED □= 415-450

LED 230V GU10 51mm

Metall Métal Metaal



Weiß matt Blanc dépoli Wit mat

**incl. 1×4,5 W, A<sup>+</sup> A<sup>++</sup>-E**

340 lm, 2.700 K

230 V

EAN 4000870 938485

**938.48**

**incl. 3×4,5 W, A<sup>+</sup> A<sup>++</sup>-E**

3×340 lm, 2.700 K

230 V

EAN 4000870 938454

**938.45**



Eisen gebürstet Acier brossé Staal geborsteld

**incl. 1×4,5 W, A<sup>+</sup> A<sup>++</sup>-E**

340 lm, 2.700 K

230 V

EAN 4000870 938492

**938.49**

**incl. 3×4,5 W, A<sup>+</sup> A<sup>++</sup>-E**

3×340 lm, 2.700 K

230 V

EAN 4000870 938461

**938.46**



Chrom Chrome Chroom

**incl. 1×4,5 W, A<sup>+</sup> A<sup>++</sup>-E**

340 lm, 2.700 K

230 V

EAN 4000870 938508

**938.50**

**incl. 3×4,5 W, A<sup>+</sup> A<sup>++</sup>-E**

3×340 lm, 2.700 K

230 V

EAN 4000870 938478

**938.47**

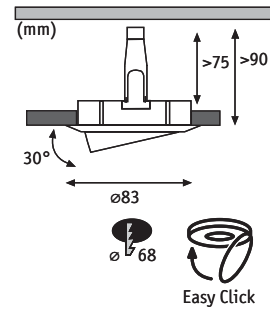

GU10  
LED □= 415-450

LED 230V GU10 51mm

Metall Métal Metaal



Wei matt Blanc dpoli Wit mat

**incl. 3×6,5 W, A<sup>+</sup> A<sup>++</sup>-E**

3×425 lm, 2.700 K

230 V

EAN 4000870 921050

**921.05**



Eisen gebrstet Acier bross Staal geborsteld

**incl. 3×6,5 W, A<sup>+</sup> A<sup>++</sup>-E**

3×425 lm, 2.700 K

230 V

EAN 4000870 921029

**921.02**

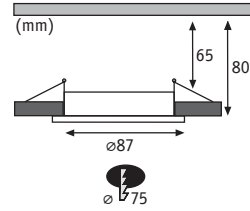

GU5,3  
**LED** □= 415-450  
 12V □= 457-460

**Premium IP65**

Alu Zink Alu zinc Alu zink

- ▶ Spritz- und Strahlwassergeschützt (IP65)
- ▶ Blendfrei durch zurückgesetztes Leuchtmittel
- ▶ Protection contre les projections d'eau et les jets d'eau (IP65)
- ▶ Le placement en arrière de l'ampoule supprime les phénomènes d'éblouissement
- ▶ Beschermtd tegen opspattend water en waterstralen (IP65)
- ▶ Verblindt niet door naar achter geplaatste lampen



Weiß Blanc Wit

**max. 35 W** < A++-E  
 12 V  
 EAN 4000870 993330  
**993.33**



Eisen gebürstet Acier brossé Staal geborsteld

**max. 35 W** < A++-E  
 12 V  
 EAN 4000870 993439  
**993.43**



Chrom Chrome Chroom

**max. 35 W** < A++-E  
 12 V  
 EAN 4000870 993422  
**993.42**

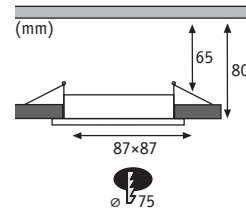

GU5,3  
**LED** □ = 415-450  
**12V** □ = 457-460

### Premium IP65 Quadro

Alu Zink Alu zinc Alu zink

- ▶ Spritz- und Strahlwassergeschützt (IP65)
- ▶ Blendfrei durch zurückgesetztes Leuchtmittel
- ▶ Protection contre les projections d'eau et les jets d'eau (IP65)
- ▶ Le placement en arrière de l'ampoule supprime les phénomènes d'éblouissement
- ▶ Beschermtd tegen opspattend water en waterstralen (IP65)
- ▶ Verblindt niet door naar achter geplaatste lampen



Wei Blanc Wit

**max. 35 W** A++-E

12 V  
 EAN 4000870 937280  
**937.28**

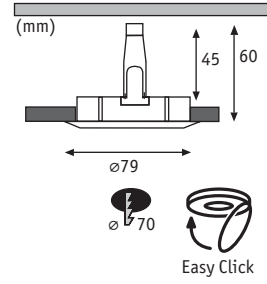

GU5,3  
LED □= 415-450  
12V □= 457-460

**Premium Halogen IP44 12V GU5,3 51mm** Alu Zink Alu zinc Alu zink



Weiß Blanc Wit

**max. 50 W** A++-E

12 V  
EAN 4000870 179437  
**179.43**



Eisen gebürstet Acier brossé Staal geborsteld

**max. 50 W** A++-E

12 V  
EAN 4000870 179451  
**179.45**



Chrom Chrome Chroom

**max. 50 W** A++-E

12 V  
EAN 4000870 179468  
**179.46**

000

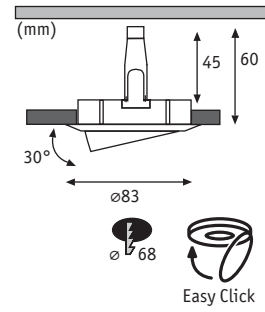

GU5,3  
LED □= 415-450  
12V □= 457-460

Premium Halogen 12V GU5,3 51mm

Alu Zink Alu zinc Alu zink



Weiß Blanc Wit

max. 50 W A++-E

12 V  
EAN 4000870 179536  
179.53



Chrom matt Chrome mat Chroom mat

max. 50 W A++-E

12 V  
EAN 4000870 179543  
179.54



Eisen gebürstet Acier brossé Staal geborsteld

max. 50 W A++-E

12 V  
EAN 4000870 179550  
179.55



Schwarz Noir Zwart

max. 50 W A++-E

12 V  
EAN 4000870 179512  
179.51

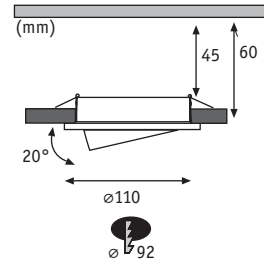

GU5,3  
LED □= 415-450  
12V □= 457-460

12V GU5,3 51mm

Metall Métal Metaal



Wei Blanc Wit

max. 50 W A++-E

12 V  
EAN 4000870 989715  
989.71



Eisen gebrstet Acier bross Staal geborsteld

max. 50 W A++-E

12 V  
EAN 4000870 989685  
989.68

000

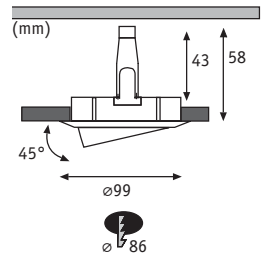

GU5,3  
LED □= 415-450  
12V □= 457-460

12V GU5,3 51mm

Alu Alu Alu



Wei Blanc Wit

max. 50 W A++-E

12 V  
EAN 4000870 987735  
987.73



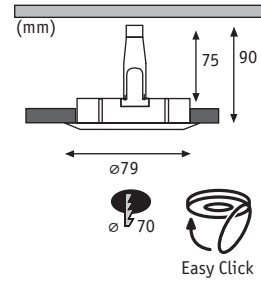

GU10  
LED □= 415-450

IP44 230V GU10 51mm

Alu Zink Alu zinc Alu zink



Weiß Blanc Wit

**max. 50 W** < A++-E  
230 V  
EAN 4000870 057926  
**5792**



Eisen gebürstet Acier brossé  
Staal geborsteld

**max. 50 W** < A++-E  
230 V  
EAN 4000870 057964  
**5796**

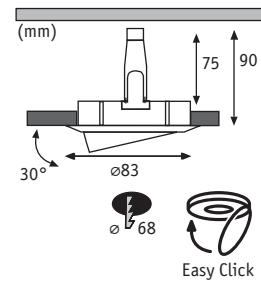

GU10  
LED □= 415-450

230V GU10 51mm

Alu Zink Alu zinc Alu zink



Weiß Blanc Wit

**max. 50 W** < A++-E  
230 V  
EAN 4000870 989401  
**989.40**



Eisen gebürstet Acier brossé  
Staal geborsteld

**max. 50 W** < A++-E  
230 V  
EAN 4000870 988787  
**988.78**



Chrom Chrome Chrom

**max. 50 W** < A++-E  
230 V  
EAN 4000870 989432  
**989.43**

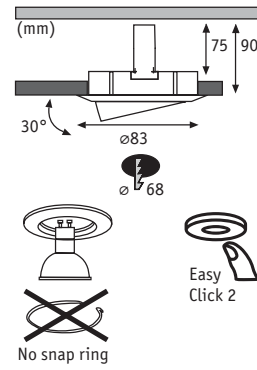

Easy Click 2

GU10  
LED □= 415-450**Premium Line easyClick2**

Alu Zink Alu zinc Alu zink

- ▶ Kein Sprengring erforderlich
- ▶ Leuchtmittelwechsel einfach durch Druck auf das Leuchtmittel
- ▶ Aucun circlip nécessaire
- ▶ Changement d'ampoule par simple pression sur l'ampoule
- ▶ Geen klemring nodig
- ▶ Lamp wordt makkelijk vervangen door druk op de lamp



Weiß Blanc Wit

**max. 50 W** <math>A^{++}-E</math>  
 230 V  
 EAN 4000870 937310  
**937.31** ↔



Eisen gebürstet Acier brossé Staal geborsteld

**max. 50 W** <math>A^{++}-E</math>  
 230 V  
 EAN 4000870 937303  
**937.30** ↔

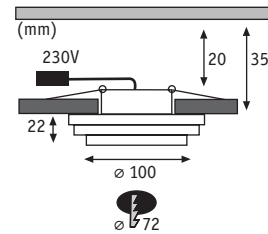
**Premium Drip IP44 230V dimmable**

Alu Zink Alu zinc Alu zink



Weiß Blanc Wit

**incl. 1x8 W** A<sup>++</sup>-A

650 lm, 2.700 K

↘ 60°

230 V

EAN 4000870 929131

**929.13**

Weiß/Champagnergold Blanc/Doré champagne Wit/Champagnergoud

**incl. 1x8 W** A<sup>++</sup>-A

650 lm, 2.700 K

↘ 60°

230 V

EAN 4000870 929148

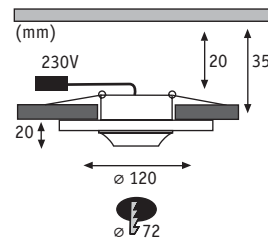
**929.14****Premium Drip 230V dimmable**

Alu Zink Alu zinc Alu zink



Weiß Blanc Wit

**incl. 1x8 W** A<sup>++</sup>-A

650 lm, 2.700 K

↘ 60°

230 V

EAN 4000870 929117

**929.11**

Weiß/Champagnergold Blanc/Doré champagne Wit/Champagnergoud

**incl. 1x8 W** A<sup>++</sup>-A

650 lm, 2.700 K

↘ 60°

230 V

EAN 4000870 929124

**929.12**

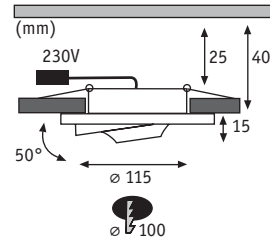

**Premium Drip adjustable 230V dimmable**    Alu Zink Alu zinc Alu zink



Weiß Blanc Wit

**incl. 1x8 W** <span style="border: 1px solid black; padding: 2px;">A++-A

650 lm, 2.700 K  
 ✕ 40°  
 230 V  
 EAN 4000870 929094  
**929.09**



Weiß/Champagnergold Blanc/Doré champagne Wit/Champagnergold

**incl. 1x8 W** <span style="border: 1px solid black; padding: 2px;">A++-A

650 lm, 2.700 K  
 ✕ 40°  
 230 V  
 EAN 4000870 929100  
**929.10**

000

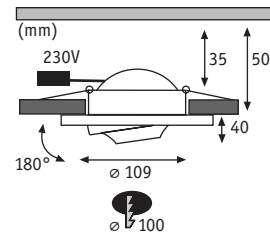

**Premium Drip tiltable 230V dimmable**    Alu Zink Alu zinc Alu zink



Weiß Blanc Wit

**incl. 1x8 W** <span style="border: 1px solid black; padding: 2px;">A++-A

650 lm, 2.700 K  
 ✕ 60°  
 230 V  
 EAN 4000870 929155  
**929.15**



Weiß/Champagnergold Blanc/Doré champagne Wit/Champagnergold

**incl. 1x8 W** <span style="border: 1px solid black; padding: 2px;">A++-A

650 lm, 2.700 K  
 ✕ 60°  
 230 V  
 EAN 4000870 929162  
**929.16**

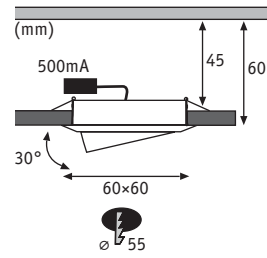

Premium Drilled Alu dimmable

Alu Alu Alu



Alu gedreht Alu tourné Alu gedraaid

incl. 3x4 W A++-A

3x500lm, 2.700 K

∠ 30°

230 V, incl. 16 VA

EAN 4000870 929186

**929.18**

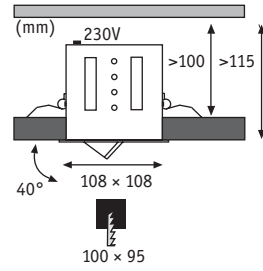

GU10  
LED □= 415-450

Premium Cardano GU10 dimmable

Metall Métal Metaal



Titan Titane Titaan

incl. 1x7 W, A+ A++-E

460 lm, 2.700 K

230 V

EAN 4000870 929056

929.05

000

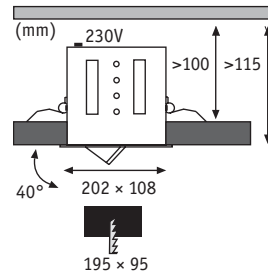

GU10  
LED □= 415-450

Premium Cardano GU10 dimmable

Metall Métal Metaal



Titan Titane Titaan

incl. 2x7 W, A+ A++-E

2x460 lm, 2.700 K

230 V

EAN 4000870 929063

929.06

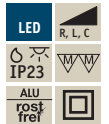
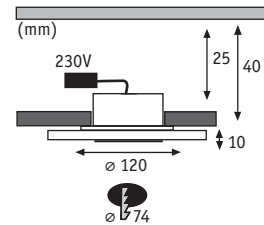

### Premium Whirl 120mm dimmable

Alu/Acryl Alu/Acryl Alu/Acryl



Alu gedreht/Satin Alu tourné/Satiné Alu gedraaid/Satijn

**incl. 3×5,5 W** <math>A^{++}-A</math>

3×460 lm, 3.000 K

∠ 110°

230 V

EAN 4000870 929070

**929.07**

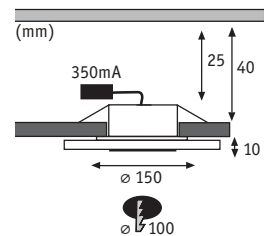

### Premium Whirl LED

Alu/Acryl Alu/Acryl Alu/Acryl



Alu gedreht/Satin Alu tourné/Satiné Alu gedraaid/Satijn

**incl. 1×6 W** <math>A^{++}-A</math>

450 lm, 3.000 K

230 V, incl. 6 VA

EAN 4000870 925355

**925.35**

**incl. 3×6 W** <math>A^{++}-A</math>

3×450 lm, 3.000 K

∠ 113°

230 V, incl. 23 VA

EAN 4000870 925430

**925.43**

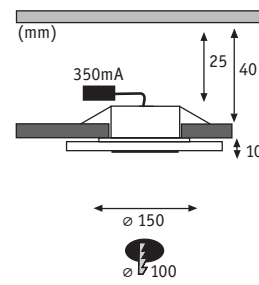
**Premium Line Whirl dimmable**

Alu/Acryl Alu/Acryl Alu/Acryl



Alu gedreht/Satin Alu tourné/Satiné Alu gedraaid/Satijn

**incl. 1×6 W**

 A<sup>++</sup>-A

450 lm, 3.000 K

✎ 110°

230 V, incl. ⚡ 9 VA

EAN 4000870 927359

**927.35**
**incl. 3×6 W**

 A<sup>++</sup>-A

3×450 lm, 3.000 K

✎ 110°

230 V, incl. ⚡ 18 VA

EAN 4000870 929179

**929.17**

000

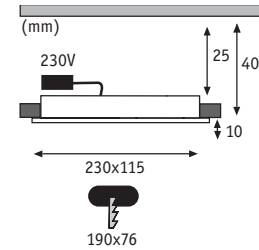
**Premium Whirl oval dimmable**

Alu/Acryl Alu/Acryl Alu/Acryl



Alu gedreht/Satin Alu tourné/Satiné Alu gedraaid/Satijn

**incl. 1×8 W**

 A<sup>++</sup>-A

680 lm, 3.000 K

✎ 110°

230 V

EAN 4000870 929087

**929.08**



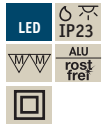
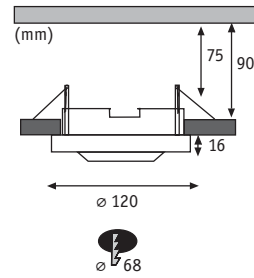

GU10  
LED □= 415-450

### Premium EBL Single Shell

Alu/Glas Alu/Verre Alu/Glas

Alu gebürstet/Klar Alu brossé/Clair Alu geborsteld/Helder



**incl. 3×3,5 W, A<sup>+</sup> A<sup>++</sup>-E**  
3×250 lm, 2.700 K  
230 V  
EAN 4000870 927267  
**927.26**

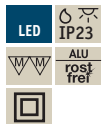
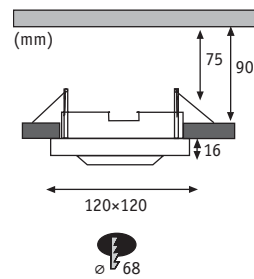

GU10  
LED □= 415-450

### Premium EBL Single Layer

Alu/Glas Alu/Verre Alu/Glas

Alu gebürstet/Klar Alu brossé/Clair Alu geborsteld/Helder

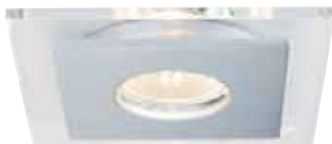

**incl. 3×3,5 W, A<sup>+</sup> A<sup>++</sup>-E**  
3×250 lm, 2.700 K  
230 V  
EAN 4000870 927274  
**927.27**

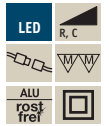
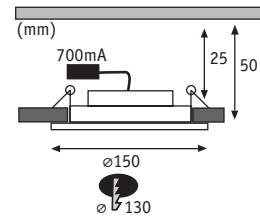

## Premium Line Dot dimmable

Alu/Glas Alu/Verre Alu/Glas



Weiß/Chrom Blanc/Chrome Wit/Chroom

incl. 3×8 W A++-A

3×520 lm, 2.700 K

∠ 98°

230 V, incl. 36 VA

EAN 4000870 926932

926.93



Alu gebürstet/Chrom Alu brossé/Chrome Alu geborsteld/Chroom

incl. 3×8 W A++-A

3×520 lm, 2.700 K

∠ 98°

230 V, incl. 36 VA

EAN 4000870 926949

926.94

000

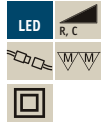
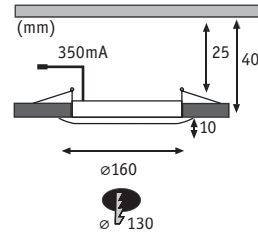
**Premium Line DecoDot dimmable**

Glas/Metall Verre/Métal Glas/Metaal



Klar/Weiß Clair/Blanc Helder/Wit

**incl. 1×7,5 W** <math>A^{++}-A</math>

 600 lm, 2.700 K  
 $\sphericalangle$  110°  
 230 V, incl. 9 VA  
 EAN 4000870 927335  
**927.33**
**incl. 2×7,5 W** <math>A^{++}-A</math>

 2×550 lm, 2.700 K  
 $\sphericalangle$  110°  
 230 V, incl. 18 VA  
 EAN 4000870 927052  
**927.05**

000

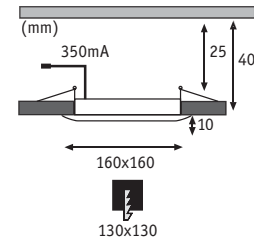
**Premium Line DecoDice dimmable**

Glas/Metall Verre/Métal Glas/Metaal



Klar/Weiß Clair/Blanc Helder/Wit

**incl. 1×7,5 W** <math>A^{++}-A</math>

 640 lm, 2.700 K  
 $\sphericalangle$  110°  
 230 V, incl. 9 VA  
 EAN 4000870 927342  
**927.34**
**incl. 2×7,5 W** <math>A^{++}-A</math>

 2×550 lm, 2.700 K  
 $\sphericalangle$  110°  
 230 V, incl. 18 VA  
 EAN 4000870 927069  
**927.06**



**Star Frill LED**

☒ Kunststoff/Aluminium Matière plastique/Aluminium Kunststoff/Aluminium

- |  |  |  |
|--|--|--|
| <ul style="list-style-type: none"> <li>▶ Effekt- und Dekolicht</li> <li>▶ Ideal als Wand- und/oder Deckendekoration</li> <li>▶ Einfach per Flachbandkabel auf Putz oder Tapete verlegen</li> </ul> | <ul style="list-style-type: none"> <li>▶ Éclairage spectaculaire et décoratif</li> <li>▶ Idéal comme décoration murale ou au plafond</li> <li>▶ Pose simple sur crépis ou papier-peint par câble plat</li> </ul> | <ul style="list-style-type: none"> <li>▶ Effect- en decolicht</li> <li>▶ Ideaal als wand- en/of plafonddecoratie</li> <li>▶ Eenvoudig met vlakbandkabel op de pleisterlaag of het behang aanbrengen</li> </ul> |
|--|--|--|

000

☞ Weiß matt/Chrom Blanc dépoli/Chrome Wit mat/Chroom

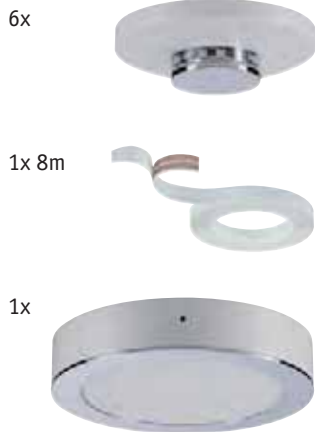

**incl. 6x0,45 W** ⚡ A++-A  
 6x28 lm, 2.700 K  
 ✕ 100°  
 230/12 V, incl. ⚡ 7 VA  
 EAN 4000870 936481  
**936.48**

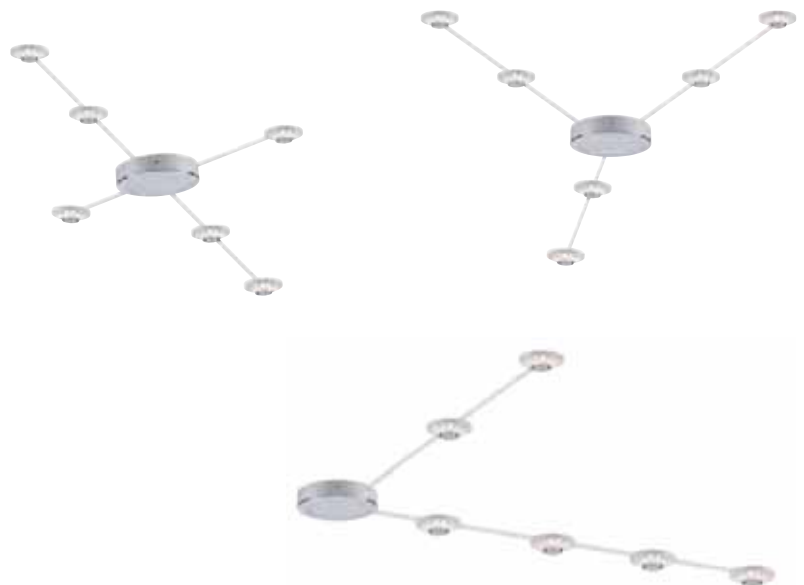



### Star Basin LED

☒ Kunststoff/Metall Matière plastique/Métal Kunststof/Metaal

- |  |  |  |
|--|--|--|
| <ul style="list-style-type: none"> <li>▶ Effekt- und Dekolicht</li> <li>▶ Ideal als Wand- und/oder Deckendekoration</li> <li>▶ Einfach per Flachbandkabel auf Putz oder Tapete verlegen</li> </ul> | <ul style="list-style-type: none"> <li>▶ Éclairage spectaculaire et décoratif</li> <li>▶ Idéal comme décoration murale ou au plafond</li> <li>▶ Pose simple sur crépis ou papier-peint par câble plat</li> </ul> | <ul style="list-style-type: none"> <li>▶ Effect- en decolicht</li> <li>▶ Ideaal als wand- en/of plafonddecoratie</li> <li>▶ Eenvoudig met vlakbandkabel op de pleisterlaag of het behang aanbrengen</li> </ul> |
|--|--|--|

☞ Weiß matt/Chrom Blanc dépoli/Chrome Wit mat/Chroom

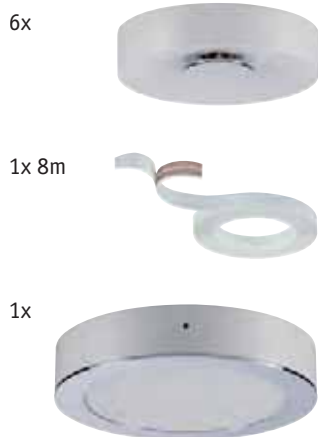

**incl. 6x0,45 W** A++-A  
 6x28 lm, 2.700 K  
 ✕ 145°  
 230/12 V, incl. 7 VA  
 EAN 4000870 936474  
**936.47**

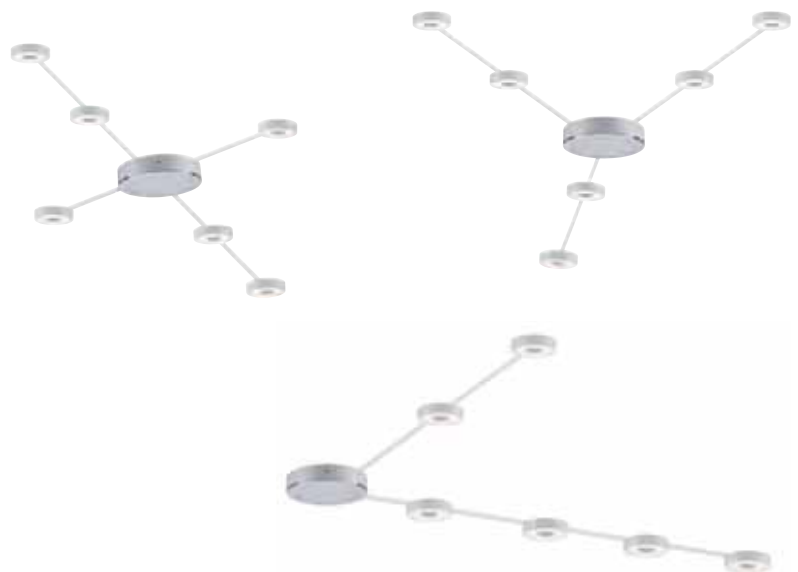

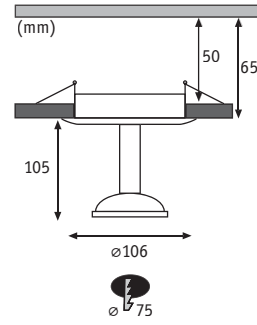

not. incl.  
Remote Control  
□ = 400



**Star Glint RGB BLE**

☒ Kunststoff Matière plastique Kunststoff



☞ Weiß matt Blanc dépoli Wit mat

**incl. 1x2,5 W** <math>A^{++}</math>-A

58 lm  
 <math>\sphericalangle</math> 40°  
 230/12 V, incl. <math>\text{---}</math> 4 VA  
 EAN 4000870 935927  
**935.92**



000

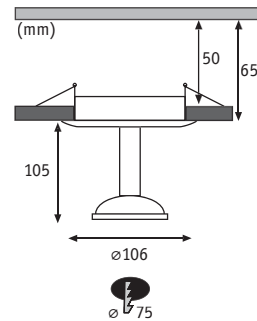

**Star Glint LED**

☒ Kunststoff Matière plastique Kunststoff



☞ Weiß matt Blanc dépoli Wit mat

**incl. 1x2,5 W** <math>A^{++}</math>-A

150 lm, 2.700 K  
 <math>\sphericalangle</math> 30°  
 230/12 V, incl. <math>\text{---}</math> 4 VA  
 EAN 4000870 935910  
**935.91**



Star Rolling LED 230V/12V

Metall/Acryl Métal/Acryl Metaal/Acryl



Wei Blanc Wit

incl. 1x (4x3 W) A++-A

1x 4x278 lm, 2.700 K  
230/12 V, incl. 12 VA  
EAN 4000870 935903  
**935.90**

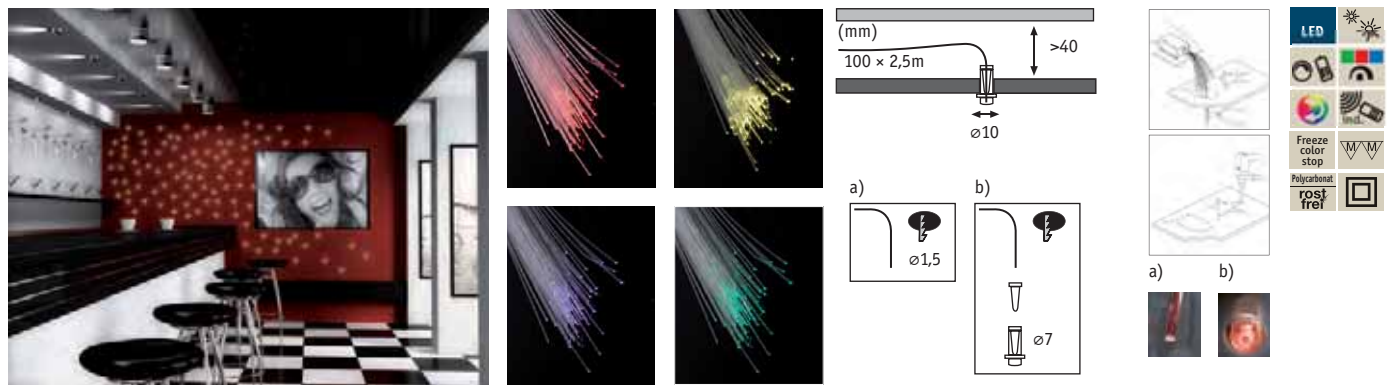

SkyLight RGB

Polycarbonat Polycarbonate Polycarbonaat

- ▶ 100 Lichtleitfasern.
- ▶ 5 Geschwindigkeiten, 6 Helligkeitsstufen, 4 RGB Funktionen, 7 Farben
- ▶ 100 fibre optique de 100 brins.
- ▶ 5 vitesses, 6 vitesses, 4 fonctions RGB, 7 couleurs
- ▶ 100 lichtgeleidende vezels.
- ▶ 5 snelheden, 6 lichtsterktes. 4 RGB functies, 7 kleuren



Multicolor Multicolor Multicolor

incl. 1x3 W  
230 V, incl. 3 VA  
EAN 4000870 922095  
**922.09**

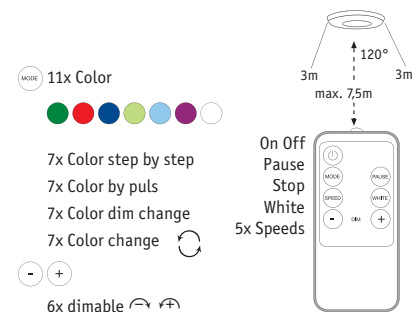

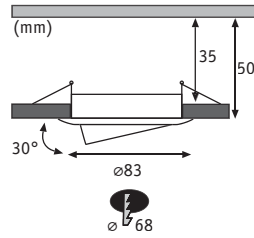



 not. incl.  
Remote Control  
□ = 400



**Goal**  Alu Zink Alu zinc Alu zink





 Weiß matt Blanc dépoli Wit mat

**incl. 3×5,2 W**  A++-A  
3×515 lm, 2.700 K  
⊘ 110°  
230/24 V, incl.  20 VA  
EAN 4000870 500064  
**500.06**



 Eisen gebürstet Acier brossé  
Staal geborsteld

**incl. 3×5,2 W**  A++-A  
3×515 lm, 2.700 K  
⊘ 110°  
230/24 V, incl.  20 VA  
EAN 4000870 500071  
**500.07**

000

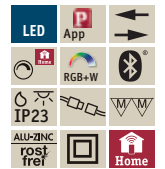
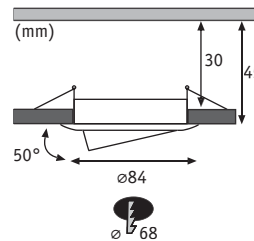



 not. incl.  
Remote Control  
□ = 400



**Premium SmartCoin BLE RGBW**  Alu Zink Alu zinc Alu zink





 Weiß matt Blanc dépoli Wit mat

**incl. 3×2 W**  A++-A  
3×100 lm  
⊘ 103°  
230/24 V, incl.  20 VA  
EAN 4000870 939406  
**939.40**



 Eisen gebürstet Acier brossé  
Staal geborsteld

**incl. 3×2 W**  A++-A  
3×100 lm  
⊘ 103°  
230/24 V, incl.  20 VA  
EAN 4000870 939413  
**939.41**



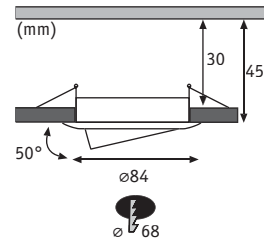
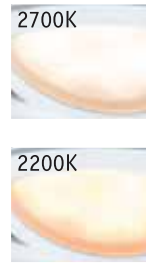

not. incl. Remote Control  
□ = 400



**SmartCoin BLE Warm Dim**

Alu Zink Alu zinc Alu zink



Weiß matt Blanc dépoli Wit mat

**incl. 3×6 W** <A++-A  
3×570 lm  
2.000 - 2.700 K  
∠ 100°  
230/24 V, incl. 20 VA  
EAN 4000870 939369  
**939.36**



Eisen gebürstet Acier brossé  
Staal geborsteld

**incl. 3×6 W** <A++-A  
3×570 lm  
2.000 - 2.700 K  
∠ 100°  
230/24 V, incl. 20 VA  
EAN 4000870 939376  
**939.37**

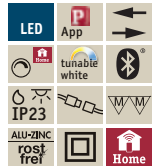
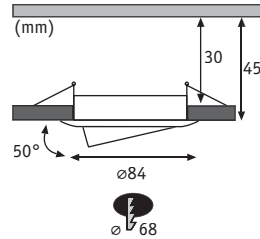

not. incl. Remote Control  
□ = 400



**SmartCoin BLE Tunable White**

Alu Zink Alu zinc Alu zink



Weiß matt Blanc dépoli Wit mat

**incl. 3×5,5 W** <A++-A  
3×570 lm  
2.700 - 6.500 K  
∠ 100°  
230/24 V, incl. 20 VA  
EAN 4000870 939383  
**939.38**



Eisen gebürstet Acier brossé  
Staal geborsteld

**incl. 3×5,5 W** <A++-A  
3×570 lm  
2.700 - 6.500 K  
∠ 100°  
230/24 V, incl. 20 VA  
EAN 4000870 939390  
**939.39**

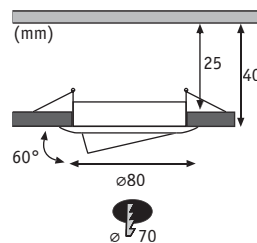

not. incl.  
Remote Control  
□= 402



**Lens Tunable White**

Alu Zink Alu zinc Alu zink



Weiß matt Blanc dépoli Wit mat

**incl. 3×3,5 W** < A++-A

3×180 lm  
2.700 - 6.500 K  
< 35°  
230/12 V, incl. 15 VA  
EAN 4000870 500644  
**500.64**

000

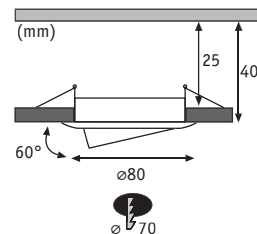

not. incl.  
Remote Control  
□= 402



**Lens RGBW**

Alu Zink Alu zinc Alu zink



Weiß matt Blanc dépoli Wit mat

**incl. 3×4,8 W** < A++-A

3×100 lm, 6.500 K  
< 35°  
230/12 V, incl. 15 VA  
EAN 4000870 500651  
**500.65**

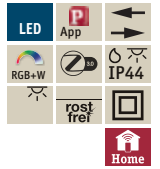
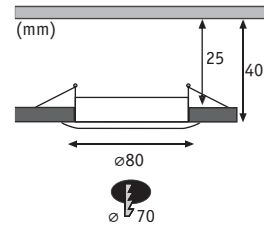

 not. incl.  
Remote Control  
□= 402



Lens RGBW

Alu Zink Alu zinc Alu zink



Chrom matt Chrome mat Chrom mat

**incl. 3×4,8W** A++-A

3×100 lm, 6.500 K

∠ 35°

230/12 V, incl. 15 VA

EAN 4000870 500682

**500.68**



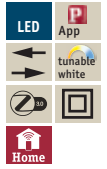

 **not. incl. Remote Control**  
□ = 402





**More Tunable White**

Alu/Kunststoff Alu/Matière plastique Alu/Kunststoff



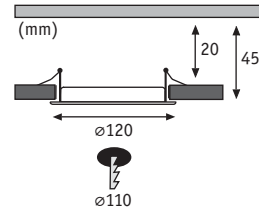

 Weiß Blanc Wit

**incl. 1×7 W**   
565 + 725 lm,  
2.700 - 6.500 K  
230/24 V, incl.  12 VA  
EAN 4000870 500712  
**500.71**



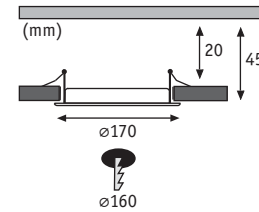

 Weiß Blanc Wit

**incl. 1×12 W**   
1.055 + 1.109 lm,  
2.700 - 6.500 K  
230/24 V, incl.  15 VA  
EAN 4000870 500729  
**500.72**



 Weiß Blanc Wit

**incl. 1×18 W**   
1.520 + 2.007 lm,  
2.700 - 6.500 K  
230/24 V, incl.  20 VA  
EAN 4000870 500736  
**500.73**

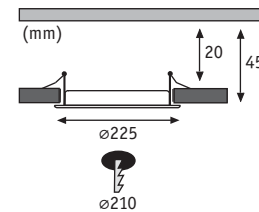

000

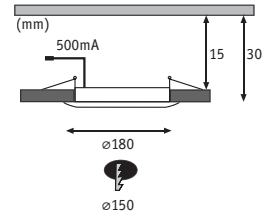

**Premium Panel IP65 3-step white switch**    Kunststoff Matière plastique Kunststof



Wei matt Blanc dpoli Wit mat

**incl. 1x9 W**    A++-A

900 + 1.200 lm,  
2.000 - 4.000 K  
230 V  
EAN 4000870 928011  
**928.01 new**

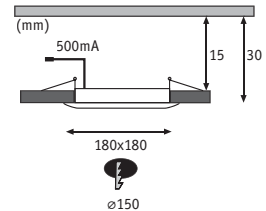
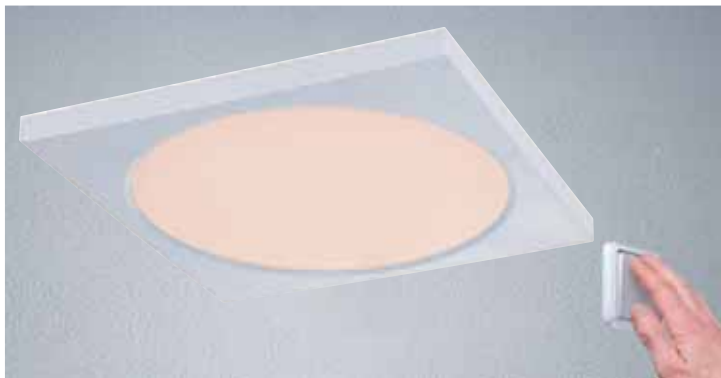

**Premium Panel IP65 3-step white switch**    Kunststoff Matière plastique Kunststof



Wei matt Blanc dpoli Wit mat

**incl. 1x9 W**    A++-A

900 + 1.200 lm,  
2.000 - 4.000 K  
230 V  
EAN 4000870 928028  
**928.02 new**

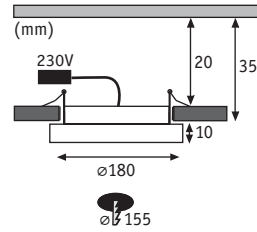

Panel Areo IP44 dimmable

Kunststoff Matière plastique Kunststoff



Wei matt Blanc dpoli Wit mat

**incl. 1x12 W** A<sup>++</sup>-A

1.300 lm, 3.000 K  
230 V

EAN 4000870 929339

**929.33 new**



Nickel matt Nickel mat Nikkel mat

**incl. 1x12 W** A<sup>++</sup>-A

1.300 lm, 3.000 K  
230 V

EAN 4000870 929353

**929.35 new**

000

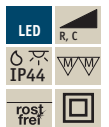
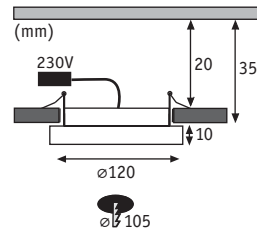
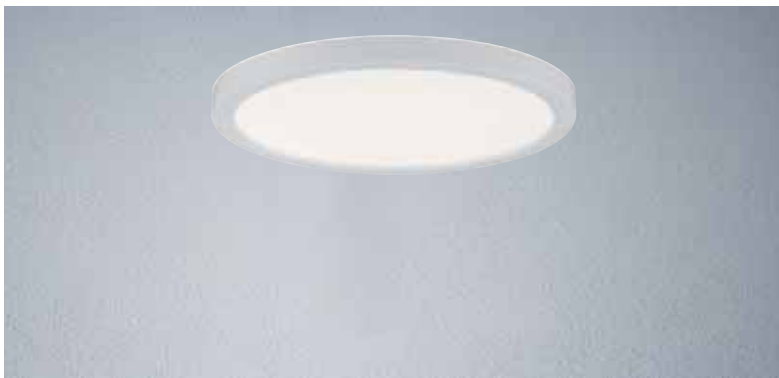

Panel Areo IP44 dimmable

Kunststoff Matière plastique Kunststoff



Wei matt Blanc dpoli Wit mat

**incl. 1x8 W** A<sup>++</sup>-A

830 lm, 3.000 K  
230 V

EAN 4000870 929346

**929.34 new**



Nickel matt Nickel mat Nikkel mat

**incl. 1x8 W** A<sup>++</sup>-A

830 lm, 3.000 K  
230 V

EAN 4000870 929360

**929.36 new**

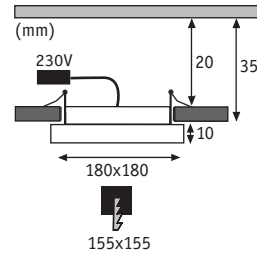

## Panel Areo IP44 dimmable

Kunststoff Matière plastique Kunststoff



Wei matt Blanc dpoli Wit mat

incl. 1x12 W A<sup>++</sup>-A

1.300 lm, 3.000 K

230 V

EAN 4000870 929377

929.37 new



Nickel matt Nickel mat Nikkel mat

incl. 1x12 W A<sup>++</sup>-A

1.300 lm, 3.000 K

230 V

EAN 4000870 929391

929.39 new

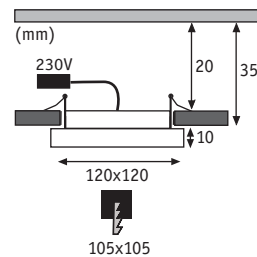

## Panel Areo IP44 dimmable

Kunststoff Matière plastique Kunststoff



Wei matt Blanc dpoli Wit mat

incl. 1x8 W A<sup>++</sup>-A

830 lm, 3.000 K

230 V

EAN 4000870 929384

929.38 new



Nickel matt Nickel mat Nikkel mat

incl. 1x8 W A<sup>++</sup>-A

830 lm, 3.000 K

230 V

EAN 4000870 929407

929.40 new

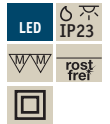
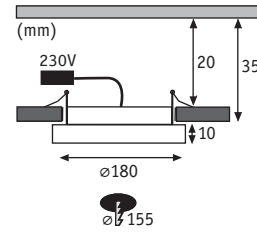

**Panel Areo IP23**

Kunststoff Matière plastique Kunststoff



Wei matt Blanc dpoli Wit mat

**incl. 1x12 W** <A++-A

1.350 lm, 3.000 K  
230 V  
EAN 4000870 929438  
**929.43 new**



Nickel matt Nickel mat Nikkel mat

**incl. 1x12 W** <A++-A

1.350 lm, 3.000 K  
230 V  
EAN 4000870 929469  
**929.46 new**

000

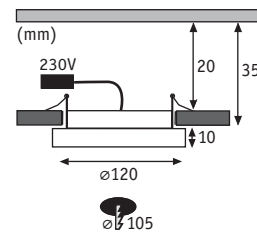

**Panel Areo IP23**

Kunststoff Matière plastique Kunststoff



Wei matt Blanc dpoli Wit mat

**incl. 1x8 W** <A++-A

920 lm, 3.000 K  
230 V  
EAN 4000870 929445  
**929.44 new**



Nickel matt Nickel mat Nikkel mat

**incl. 1x8 W** <A++-A

920 lm, 3.000 K  
230 V  
EAN 4000870 929476  
**929.47 new**



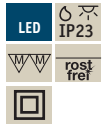
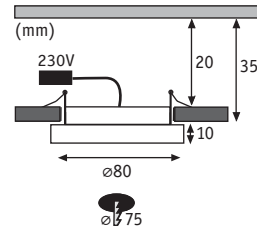

## Panel Areo IP23

Kunststoff Matière plastique Kunststoff



⌚ Weiß matt Blanc dépoli Wit mat

**incl. 1x5 W** <span style="border: 1px solid black; padding: 2px;">A++-A

615 lm, 3.000 K

230 V

EAN 4000870 929452

**929.45 new**

⌚ Nickel matt Nickel mat Nikkel mat

**incl. 1x5 W** <span style="border: 1px solid black; padding: 2px;">A++-A

615 lm, 3.000 K

230 V

EAN 4000870 929483

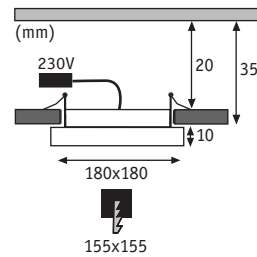
**929.48 new**

## Panel Areo IP23

Kunststoff Matière plastique Kunststoff



⌚ Weiß matt Blanc dépoli Wit mat

**incl. 1x12 W** <span style="border: 1px solid black; padding: 2px;">A++-A

1.350 lm, 3.000 K

230 V

EAN 4000870 929490

**929.49 new**

⌚ Nickel matt Nickel mat Nikkel mat

**incl. 1x12 W** <span style="border: 1px solid black; padding: 2px;">A++-A

1.350 lm, 3.000 K

230 V

EAN 4000870 929520

**929.52 new**

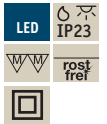
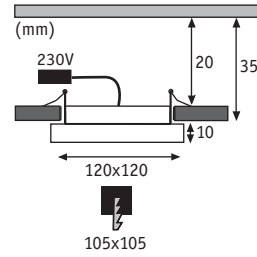

**Panel Areo IP23**

Kunststoff Matière plastique Kunststoff



Wei matt Blanc dpoli Wit mat

**incl. 1x8 W** A++-A

920 lm, 3.000 K  
230 V  
EAN 4000870 929506  
**929.50 new**



Nickel matt Nickel mat Nikkel mat

**incl. 1x8 W** A++-A

920 lm, 3.000 K  
230 V  
EAN 4000870 929537  
**929.53 new**

000

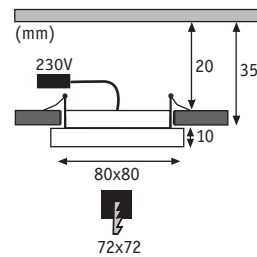

**Panel Areo IP23**

Kunststoff Matière plastique Kunststoff



Wei matt Blanc dpoli Wit mat

**incl. 1x5 W** A++-A

615 lm, 3.000 K  
230 V  
EAN 4000870 929513  
**929.51 new**



Nickel matt Nickel mat Nikkel mat

**incl. 1x5 W** A++-A

615 lm, 3.000 K  
230 V  
EAN 4000870 929544  
**929.54 new**

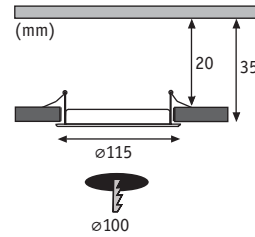

Panel dimmable IP44

Kunststoff Matière plastique Kunststoff

Wei Blanc Wit



incl. 1x6 W A++-A

650 lm, 4.000 K

∠ 120°

220-240V

EAN 4000870 929414

**929.41 new**

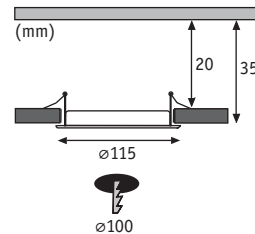

Quality Line Panel IP44

Kunststoff Matière plastique Kunststoff

Wei Blanc Wit



incl. 1x6 W A++-A

589 lm, 2.700 K

∠ 110°

230 V

EAN 4000870 920619

**920.61**

incl. 1x6 W A++-A

671 lm, 4.000 K

∠ 110°

230 V

EAN 4000870 920589

**920.58**

Chrom matt Chrome mat Chroom mat



incl. 1x6 W A++-A

589 lm, 2.700 K

∠ 110°

230 V

EAN 4000870 920732

**920.73**

incl. 1x6 W A++-A

671 lm, 4.000 K

∠ 110°

230 V

EAN 4000870 920701

**920.70**

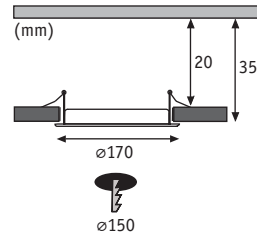

Panel dimmable IP44

Kunststoff Matière plastique Kunststoff

Wei Blanc Wit



**incl. 1x12 W** <math>A^{++}-A</math>

1.290 lm, 4.000 K  
 <math>\sphericalangle</math> 120°  
 220-240V  
 EAN 4000870 929421  
**929.42 new**

000

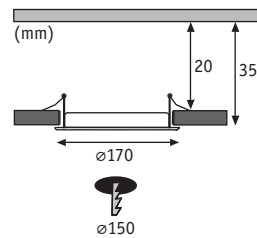

Quality Line Panel IP44

Kunststoff Matière plastique Kunststoff

Wei Blanc Wit



**incl. 1x12 W** <math>A^{++}-A</math>

1.118 lm, 2.700 K  
 <math>\sphericalangle</math> 120°  
 230 V  
 EAN 4000870 920626  
**920.62**

**incl. 1x12 W** <math>A^{++}-A</math>

1.262 lm, 4.000 K  
 <math>\sphericalangle</math> 120°  
 230 V  
 EAN 4000870 920596  
**920.59**

Chrom matt Chrome mat Chroom mat



**incl. 1x12 W** <math>A^{++}-A</math>

1.118 lm, 2.700 K  
 <math>\sphericalangle</math> 110°  
 230 V  
 EAN 4000870 920749  
**920.74**

**incl. 1x12 W** <math>A^{++}-A</math>

1.262 lm, 4.000 K  
 <math>\sphericalangle</math> 120°  
 230 V  
 EAN 4000870 920718  
**920.71**

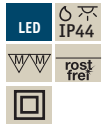
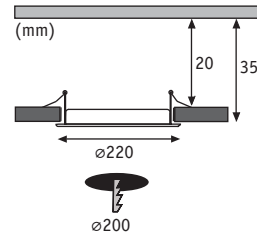

## Quality Line Panel IP44

Kunststoff Matière plastique Kunststoff



Wei Blanc Wit

**incl. 1x18 W** <A++-A

1.724 lm, 2.700 K

∠ 110°

230 V

EAN 4000870 920633

**920.63****incl. 1x18 W** <A++-A

2.011 lm, 4.000 K

∠ 120°

230 V

EAN 4000870 920602

**920.60**

Chrom matt Chrome mat Chroom mat

**incl. 1x18 W** <A++-A

1.724 lm, 2.700 K

∠ 110°

230 V

EAN 4000870 920756

**920.75****incl. 1x18 W** <A++-A

2.011 lm, 4.000 K

∠ 120°

230 V

EAN 4000870 920725

**920.72**

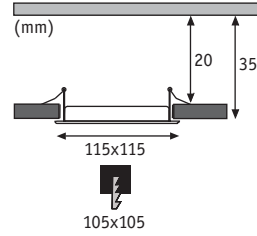

**Quality Line Panel IP44**

Kunststoff Matière plastique Kunststoff



Wei Blanc Wit

**incl. 1x6 W** <A++-A

589 lm, 2.700 K  
 <math>\sphericalangle</math> 110°  
 230 V  
 EAN 4000870 920671  
**920.67**

**incl. 1x6 W** <A++-A

671 lm, 4.000 K  
 <math>\sphericalangle</math> 100°  
 230 V  
 EAN 4000870 920640  
**920.64**



Chrom matt Chrome mat Chroom mat

**incl. 1x6 W** <A++-A

589 lm, 2.700 K  
 <math>\sphericalangle</math> 110°  
 230 V  
 EAN 4000870 920794  
**920.79**

**incl. 1x6 W** <A++-A

671 lm, 4.000 K  
 <math>\sphericalangle</math> 100°  
 230 V  
 EAN 4000870 920763  
**920.76**

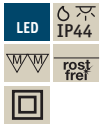
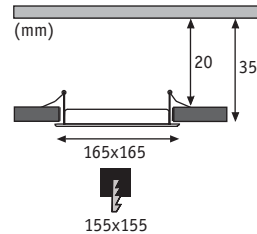

**Quality Line Panel IP44**

Kunststoff Matière plastique Kunststoff



Wei Blanc Wit

**incl. 1x12 W** <A++-A

1.119 lm, 2.700 K  
 <math>\sphericalangle</math> 110°  
 230 V  
 EAN 4000870 920688  
**920.68**

**incl. 1x12 W** <A++-A

1.263 lm, 4.000 K  
 <math>\sphericalangle</math> 120°  
 230 V  
 EAN 4000870 920657  
**920.65**



Chrom matt Chrome mat Chroom mat

**incl. 1x12 W** <A++-A

1.119 lm, 2.700 K  
 <math>\sphericalangle</math> 110°  
 230 V  
 EAN 4000870 920800  
**920.80**

**incl. 1x12 W** <A++-A

1.263 lm, 4.000 K  
 <math>\sphericalangle</math> 120°  
 230 V  
 EAN 4000870 920770  
**920.77**

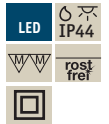
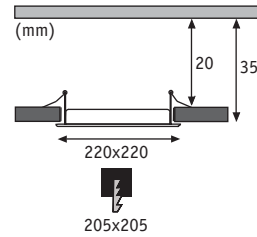
**Quality Line Panel IP44**

Kunststoff Matière plastique Kunststoff



Weiß Blanc Wit

**incl. 1x18 W** <A++-A

1.724 lm, 2.700 K

&lt;math&gt;\sphericalangle 110^\circ&lt;/math&gt;

230 V

EAN 4000870 920695

**920.69**
**incl. 1x18 W** <A++-A

2.011 lm, 4.000 K

&lt;math&gt;\sphericalangle 120^\circ&lt;/math&gt;

230 V

EAN 4000870 920664

**920.66**

Chrom matt Chrome mat Chroom mat

**incl. 1x18 W** <A++-A

1.724 lm, 2.700 K

&lt;math&gt;\sphericalangle 110^\circ&lt;/math&gt;

230 V

EAN 4000870 920817

**920.81**
**incl. 1x18 W** <A++-A

2.011 lm, 4.000 K

&lt;math&gt;\sphericalangle 120^\circ&lt;/math&gt;

230 V

EAN 4000870 920787

**920.78**



### *Downlights | CabinetLight*

Unterschrankleuchten für die optimale Ausleuchtung, z.B. von Arbeitsbereichen in der Küche, von Wandschränken oder Regalen.

Appliques sous placards pour un éclairage optimal, par exemple des plans de travail dans la cuisine, des placards muraux ou des étagères.

Onderkastlampen voor de optimale verlichting van bijv. werkbladen in de keuken, wandkasten of rekken.



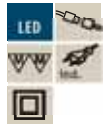
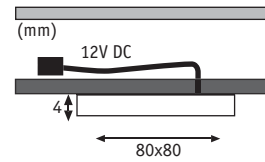

## Furniture LED Leaf

Alu Alu Alu



Alu gebürstet Alu brossé Alu geborsteld

**incl. 3×4,7 W** <math>A^{++}</math>-A

3×310 lm, 2.700 K

&lt;math&gt;\sphericalangle&lt;/math&gt; 120°

230/12 V, incl. &lt;math&gt;\text{---}&lt;/math&gt; 15 VA

EAN 4000870 935613

**935.61**

000

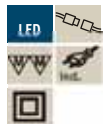
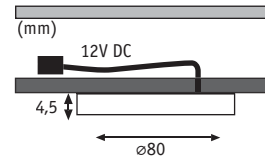

## Furniture LED Leaf

Alu Alu Alu



Alu gebürstet Alu brossé Alu geborsteld

**incl. 3×4 W** <math>A^{++}</math>-A

3×280 lm, 2.700 K

&lt;math&gt;\sphericalangle&lt;/math&gt; 120°

230/12 V, incl. &lt;math&gt;\text{---}&lt;/math&gt; 12 VA

EAN 4000870 935620

**935.62**

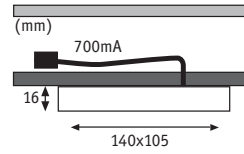

**Furniture LED Vane**

Alu Alu Alu



Wei matt Blanc dpoli Wit mat

**incl. 1x6,7 W** <A++-A  
 450 lm, 2.700 K  
 230/12 V, incl. 8 VA  
 EAN 4000870 920329  
**920.32**

**incl. 2x6,7 W** <A++-A  
 2x450 lm, 2.700 K  
 230/12 V, incl. 15 VA  
 EAN 4000870 935835  
**935.83**

000

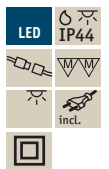
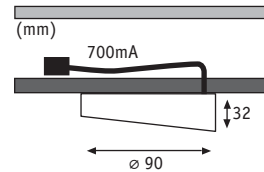

**Furniture LED Gate**

Alu Alu Alu



Eisen gebrstet Acier bross Staal geborsteld

**incl. 1x6,2 W** <A++-A  
 620 lm, 2.700 K  
 230/12 V, incl. 8 VA  
 EAN 4000870 920336  
**920.33**

**incl. 2x6,2 W** <A++-A  
 2x620 lm, 2.700 K  
 230/12 V, incl. 15 VA  
 EAN 4000870 935828  
**935.82**

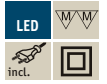
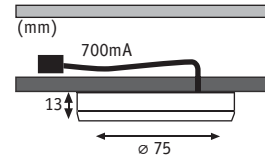

Furniture LED Unity

Metall/Acryl Métal/Acryl Metaal/Acryl



Eisen gebürstet Acier brossé Staal geborsteld

incl. 3×4,5 W A++-A

3×360 lm, 2.700 K

✕ 120°

230 V, incl. ⚡ 15 VA

EAN 4000870 935644

935.64

000

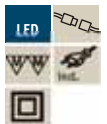
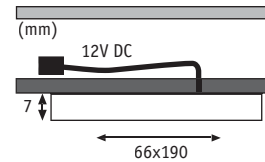

Furniture LED Pattern

Kunststoff Matière plastique Kunststoff



Chrom matt Chrome mat Chroom mat

incl. 3×2,2 W A++-A

3×160 lm, 2.700 K

✕ 70°

230/12 V, incl. ⚡ 12 VA

EAN 4000870 935637

935.63



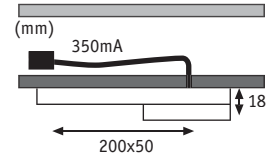

Furniture LED Setup

Metall Métal Metaal



Eisen gebürstet Acier brossé Staal geborsteld

incl. 3×3,2 W A++-A

3×220 lm, 2.700 K  
 ✕ 120°

230 V, incl. 15 VA  
 EAN 4000870 935668

**935.66**

000

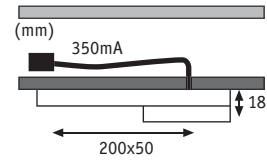

Furniture LED Setup

Metall/Acryl Métal/Acryl Metaal/Acryl



Eisen gebürstet Acier brossé Staal geborsteld

incl. 3×3,2 W A++-A

3×250 lm, 2.700 K  
 ✕ 120°

230 V, incl. 15 VA  
 EAN 4000870 935675

**935.67**

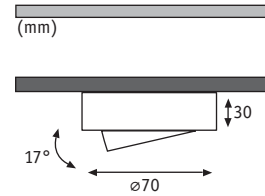

G4  
**LED** □= 415-450  
**12V** □= 457-460

## Furniture Dress

Alu Alu Alu



Weiß Blanc Wit

**max. 20 W** <A++-E

12 V  
 EAN 4000870 935149  
**935.14** 📦



Eisen gebürstet Acier brossé Staal geborsteld

**max. 20 W** <A++-E

12 V  
 EAN 4000870 935125  
**935.12** 📦



Chrom Chrome Chroom

**max. 20 W** <A++-E

12 V  
 EAN 4000870 935118  
**935.11** 📦

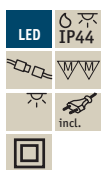
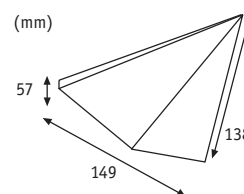

## Furniture LED Kite

Alu Alu Alu



Alu gebürstet Alu brossé Alu geborsteld

**incl. 1×6,2 W** <A++-A

580 lm, 2.700 K  
 230/12 V, incl. 8 VA  
 EAN 4000870 920312  
**920.31**

**incl. 2×6,2 W** <A++-A

2×580 lm, 2.700 K  
 230/12 V, incl. 15 VA  
 EAN 4000870 935842  
**935.84**

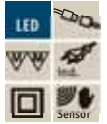
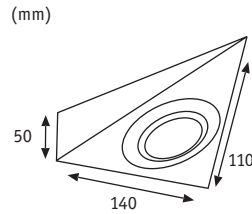

**Furniture LED Triangle Sensor**

Metall/Glas Métal/Verre Metaal/Glas



Eisen gebürstet Acier brossé Staal geborsteld

**incl. 3×2,8 W** A<sup>++</sup>-A

3×170 lm, 2.700 K  
 ∠ 100°  
 230/12 V, incl. 12 VA  
 EAN 4000870 935729  
**935.72**

000

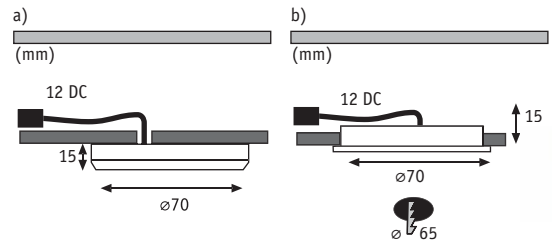

**Furniture LED Platy**

Kunststoff Matière plastique Kunststof



Weiß matt Blanc dépoli Wit mat

**incl. 3×2,5 W** A<sup>++</sup>-A

3×170 lm, 3.000 K  
 ∠ 105°  
 230/12 V, incl. 7,5 VA  
 EAN 4000870 935736  
**935.73**



Chrom matt Chrome mat Chroom mat

**incl. 3×2,5 W** A<sup>++</sup>-A

3×170 lm, 3.000 K  
 ∠ 105°  
 230/12 V, incl. 7,5 VA  
 EAN 4000870 935804  
**935.80**

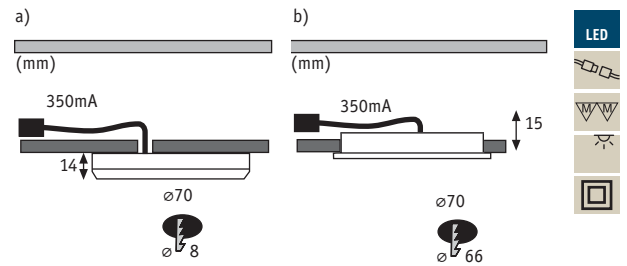

Furniture LED Platy

Metall Métal Metaal



Alu Alu Alu

incl. 3×3 W A<sup>++</sup>-A

3×244 lm, 2.700 K

✕ 180°

230 V, incl. ⚡ 12 VA

EAN 4000870 935477

935.47

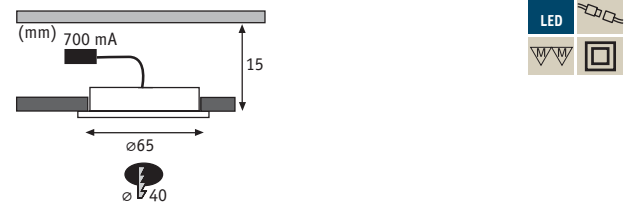

Furniture Whirl Mini LED

Acryl Acryl Acryl



Satin Satiné Satijn

incl. 3×2,4 W A<sup>++</sup>-A

3×115 lm, 2.700 K

✕ 100°

230 V, incl. ⚡ 7 VA

EAN 4000870 998656

998.65

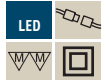
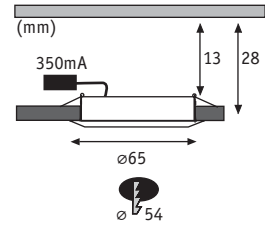

**Mirror Cabinet downlight**

Aluminium/Kunststoff Aluminium/Matière plastique Aluminium/Kunststof

- ▶ Umrüstsatz für Spiegelschränke
- ▶ Kit équipement pour armoires de toilette
- ▶ Uitrustingsset voor spiegelkasten



Wei matt Blanc dépoli Wit mat

**incl. 2x2,5 W** A++-A

2x225 lm, 3.000 K

∠ 85°

230/12 V, incl. 7 VA

EAN 4000870 999219

**999.21** new



Chrom Chrome Chroom

**incl. 2x2,5 W** A++-A

2x225 lm, 3.000 K

∠ 85°

230/12 V, incl. 7 VA

EAN 4000870 999202

**999.20** new



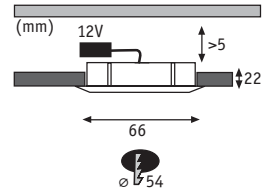

## Furniture LED

Metall Métal Metaal



Wei Blanc Wit

**incl. 3x1 W** A<sup>+</sup>-A

3x34 lm, 2.700 K  
 230/12 V, incl. 3,6 VA  
 EAN 4000870 998151  
**998.15**



Eisen gebrstet Acier bross Staal geborsteld

**incl. 3x1 W** A<sup>+</sup>-A

3x34 lm, 2.700 K  
 230/12 V, incl. 3,6 VA  
 EAN 4000870 998120  
**998.12**



Chrom Chrome Chroom

**incl. 3x1 W** A<sup>+</sup>-A

3x34 lm, 2.700 K  
 230/12 V, incl. 3,6 VA  
 EAN 4000870 998144  
**998.14**

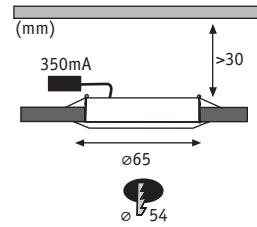

## Furniture LED

Metall Métal Metaal



Weiß Blanc Wit

**incl. 1×4,5 W** <A++-A305 lm, 2.700 K  
✗ 180°230 V, incl. 6 VA  
EAN 4000870 935552**935.55****incl. 3×4,5 W** <A++-A3×305 lm, 2.700 K  
✗ 180°230 V, incl. 12 VA  
EAN 4000870 935545**935.54**

Eisen gebürstet Acier brossé Staal geborsteld

**incl. 1×4,5 W** <A++-A305 lm, 2.700 K  
✗ 180°230 V, incl. 6 VA  
EAN 4000870 935569**935.56****incl. 3×4,5 W** <A++-A3×305 lm, 2.700 K  
✗ 180°230 V, incl. 12 VA  
EAN 4000870 935538**935.53**

Chrom Chrome Chroom

**incl. 3×4,5 W** <A++-A3×305 lm, 2.700 K  
✗ 180°230 V, incl. 12 VA  
EAN 4000870 935521**935.52**

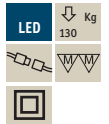
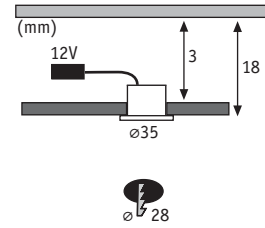

## Furniture Mini LED

Metall Métal Metaal



Eisen gebürstet Acier brossé Staal geborsteld

**incl. 5×0,4 W** <A++-A

5×20 lm, 2.700 K

✗ 90°

230/12 V, incl. 3,6 VA

EAN 4000870 935866

**935.86**

Eisen gebürstet Acier brossé Staal geborsteld

**incl. 5×0,4 W** <A++-A

5×20 lm, 6.500 K

✗ 90°

230/12 V, incl. 3,6 VA

EAN 4000870 935880

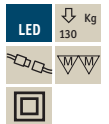
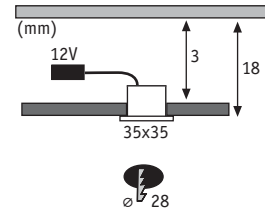
**935.88**

## Furniture Mini LED

Metall Métal Metaal



Eisen gebürstet Acier brossé Staal geborsteld

**incl. 5×0,4 W** <A++-A

5×20 lm, 2.700 K

✗ 90°

230/12 V, incl. 3,6 VA

EAN 4000870 935873

**935.87**

Eisen gebürstet Acier brossé Staal geborsteld

**incl. 5×0,4 W** <A++-A

5×20 lm, 6.500 K

✗ 90°

230/12 V, incl. 3,6 VA

EAN 4000870 935897

**935.89**

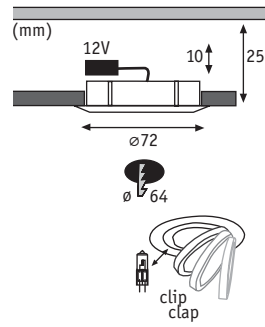

G4  
LED □= 415-450  
12V □= 457-460

**Furniture Klipp Klapp**

Metall/Glas Métal/Verre Metaal/Glas



Weiß Blanc Wit

**max. 20 W** A++-E

12 V  
EAN 4000870 984666  
**984.66**



Eisen gebürstet Acier brossé Staal geborsteld

**max. 20 W** A++-E

12 V  
EAN 4000870 984079  
**984.07**



Chrom Chrome Chroom

**max. 20 W** A++-E

12 V  
EAN 4000870 984024  
**984.02**

000

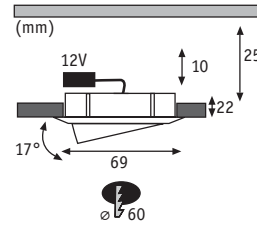

G4  
 LED □= 415-450  
 12V □= 457-460

### Micro Line Swivel

Metall/Glas Métal/Verre Metaal/Glas



Eisen gebürstet Acier brossé Staal geborsteld

max. 20 W A++-E

12 V  
 EAN 4000870 984741  
 984.74



Schwarz Noir Zwart

max. 20 W A++-E

12 V  
 EAN 4000870 984710  
 984.71

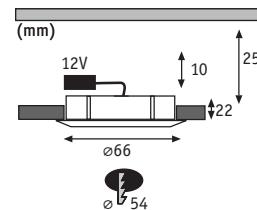

G4  
 LED □= 415-450  
 12V □= 457-460

### Micro Line Structure

Metall/Glas Métal/Verre Metaal/Glas



Weiß Blanc Wit

max. 20 W A++-E

12 V  
 EAN 4000870 984321  
 984.32



Eisen gebürstet Acier brossé Staal geborsteld

max. 20 W A++-E

12 V  
 EAN 4000870 984499  
 984.49



Chrom Chrome Chrom

max. 20 W A++-E

12 V  
 EAN 4000870 984628  
 984.62

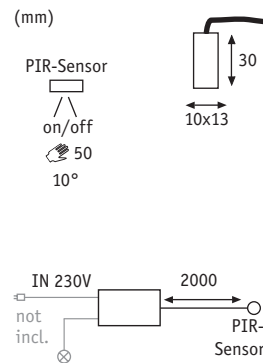

### PIR-Sensor 230V

☒ Kunststoff Matière plastique Kunststoff

- ▶ Näherungsschalter für die An-/Aus-Schaltung der LED-Strips und anderer Produkte
- ▶ Max. 75 W (magnetische Trafos)
- ▶ Max. 60 W (elektronische Last)
- ▶ Max. 250 W (Glühlampen)

- ▶ Interrupteur de proximité Marche/Arrêt des rubans LED et autres produits
- ▶ Max. 75 W (transformateurs magnétiques)
- ▶ Max. 60 W (charge électronique)
- ▶ Max. 250 W (ampoules à incandescence)

- ▶ Naderingsschakelaar voor het in-/uitschakelen van de LED-strips en andere producten
- ▶ Max. 75 W (magnetische trafo's)
- ▶ Max. 60 W (elektronische last)
- ▶ Max. 250 W (gloeilampen)



☒ Weiß Blanc Wit

**max. 60 W**

230 V

⌀19 ↔85 ↗36 mm

EAN 4000870 935811

**935.81**



## Downlights | 2Easy

*Kombinieren Sie selbst! Alles ist möglich!*

*Composez vous-même votre luminaire ! Tout est possible !*

*Combineer zelf! Alles is mogelijk!*

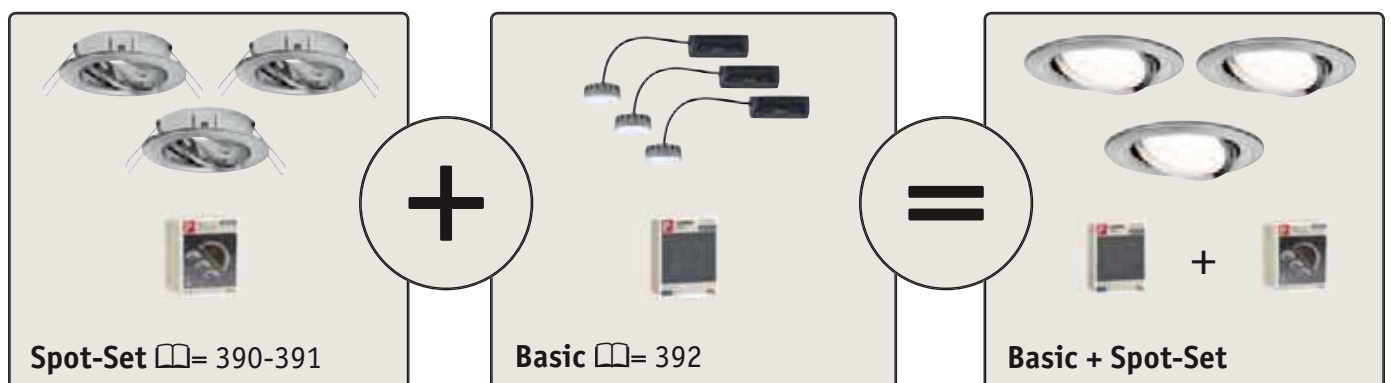

**Einbauringe**  
(Spot-Set)

**Anneaux de montage**  
(Spot-Set)

**Inbouwringen**  
(Spot-Set)

**Wählen Sie Ihr Licht**  
(Basic)

**Choisissez votre lumière**  
(Basic)

**Kies uw licht**  
(Basic)

**Installeren - zusammenstecken**  
Fertig ist die individuelle Lichtlösung.  
Und welchen Lichtgeschmack haben Sie?

**Poser** L'éclairage personnalisé choisi est terminé. Et quels sont vos préférences en matière d'éclairage ?

**Monteren** Klaar is uw individuele lichtoplossing.  
En welke lampen bevallen u?

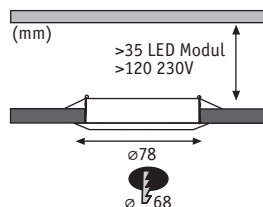

Basic  
□ = 392

2Easy Spot-Set Premium Nova

Alu Zink Alu zinc Alu zink



Wei matt Blanc dpoli Wit mat

max. 3×35 W <math>\triangleleft</math> A++-E  
EAN 4000870 936351  
936.35



Eisen gebrstet Acier bross Staal geborsteld

max. 3×35 W <math>\triangleleft</math> A++-E  
EAN 4000870 936375  
936.37



Alu gedreht Alu tourn Alu gedraaid

max. 3×35 W <math>\triangleleft</math> A++-E  
EAN 4000870 936368  
936.36

000

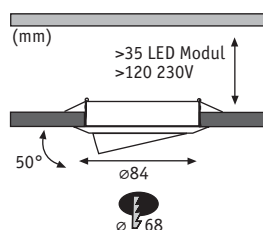

Basic  
□ = 392

2Easy Spot-Set Premium Nova

Alu Zink Alu zinc Alu zink



Wei matt Blanc dpoli Wit mat

max. 3×35 W <math>\triangleleft</math> A++-E  
EAN 4000870 936436  
936.43



Eisen gebrstet Acier bross Staal geborsteld

max. 3×35 W <math>\triangleleft</math> A++-E  
EAN 4000870 936450  
936.45



Alu gedreht Alu tourn Alu gedraaid

max. 3×35 W <math>\triangleleft</math> A++-E  
EAN 4000870 936443  
936.44



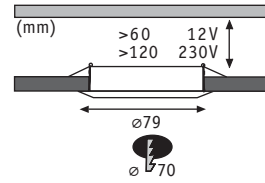

☹ ☹ ☹  
**Basic**  
 □ = 392

**2Easy Spot-Set Premium**

☒ Alu Zink Alu zinc Alu zink



☞ WeiÙ Blanc Wit

**max. 3×50 W** <math>\triangleleft</math> A++-E  
 EAN 4000870 997390  
**997.39**



☞ Eisen gebürstet Acier brossé  
 Staal geborsteld

**max. 3×50 W** <math>\triangleleft</math> A++-E  
 EAN 4000870 997383  
**997.38**

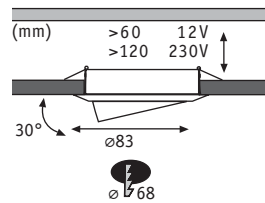

☹ ☹ ☹  
**Basic**  
 □ = 392

**2Easy Spot-Set Premium**

☒ Alu Zink Alu zinc Alu zink



☞ WeiÙ Blanc Wit

**max. 3×50 W** <math>\triangleleft</math> A++-E  
 EAN 4000870 997420  
**997.42**



☞ Eisen gebürstet Acier brossé  
 Staal geborsteld

**max. 3×50 W** <math>\triangleleft</math> A++-E  
 EAN 4000870 997437  
**997.43**

*Kombinieren Sie selbst! Alles ist möglich!*

*Composez vous-même votre luminaire ! Tout est possible !*

*Combineer zelf! Alles is mogelijk!*

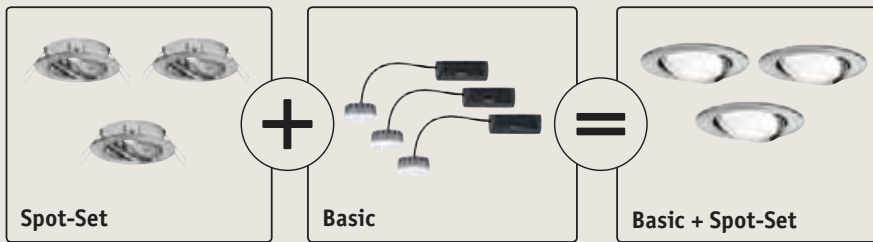

☉☉☉  
Spot-Set  
☐= 390-391

### 2Easy Basic LED Coin 230V

☐ Kunststoff Matière plastique Kunststoff



☞ Satin Satiné Satijn

**incl. 3×6,8 W**

3×592 lm, 2.700 K ⊡A+  
☞ 120°

230 V  
EAN 4000870 938867  
**938.86**

**incl. 3×6,8 W**

3×633 lm, 2.700 K ⊡A+  
☞ 120°

230 V  
EAN 4000870 938874  
**938.87**

LED ☐

### 2Easy Basic LED Coin 230V dimmable

☐ Kunststoff Matière plastique Kunststoff



☞ Satin Satiné Satijn

**incl. 3×7 W**

3×482 lm, 2.700 K ⊡A+  
☞ 105°

230 V  
EAN 4000870 938393  
**938.39**

LED ☐ R, L

### 2Easy Basic LED Coin 230V

☐ Kunststoff Matière plastique Kunststoff



☞ Satin Satiné Satijn

**incl. 3×6,8 W**

3×535 lm, 2.700 K ⊡A+  
☞ 110°

230 V  
EAN 4000870 938201  
**938.20**

LED ☐

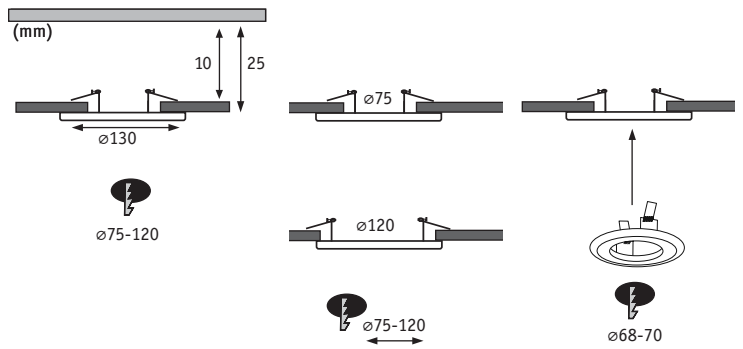

**Downlight adapter**

Metall Métal Metaal

- |   |  |   |
|---|--|---|
| <ul style="list-style-type: none"> <li>▶ Adapterring zur Verringerung des Einbaudurchmessers</li> <li>▶ Für starre und schwenkbare Paulmann-Einbauleuchten (Einbaudurchmesser 68-70 mm)</li> <li>▶ Geringe Mindesteinbautiefe von nur 25mm</li> </ul> | <ul style="list-style-type: none"> <li>▶ Bague de réduction du diamètre d'encastrement</li> <li>▶ Pour encastrés fixes et orientables Paulmann (diamètre d'encastrement 68-70 mm)</li> <li>▶ Faible profondeur d'encastrement: seulement 25mm</li> </ul> | <ul style="list-style-type: none"> <li>▶ Adapterring voor het verminderen van de inbouwdiameter</li> <li>▶ Voor stijve en zwenkbare Paulmann-inbouwlampen (inbouwdiameter 68-70mm)</li> <li>▶ Geringe minimale inbouwdiepte van slechts 25mm</li> </ul> |
|---|--|---|



Wei matt  
Blanc dépoli Wit mat

**max. 50 W**  
EAN 4000870 924990  
**924.99** **new**



Eisen gebürstet Acier brossé  
Staal geborsteld

**max. 50 W**  
EAN 4000870 924983  
**924.98** **new**

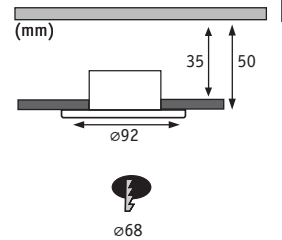
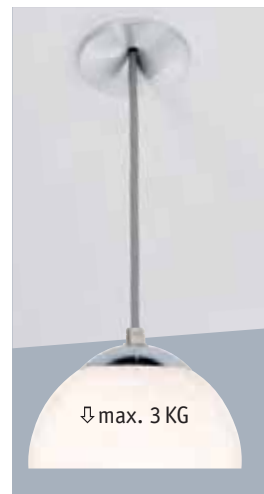

**Pendant Adapter**

Metall/Kunststoff Métal/Matière plastique Metaal/Kunststof

- |  |   |  |
|--|---|--|
| <ul style="list-style-type: none"> <li>▶ Max. 3 kg</li> <li>▶ Für Kabel bis max. 6,5 mm Durchmesser</li> </ul> | <ul style="list-style-type: none"> <li>▶ 3kg maximum</li> <li>▶ Pour câbles de section maximale 6,5 mm</li> </ul> | <ul style="list-style-type: none"> <li>▶ Max. 3 kg</li> <li>▶ Voor kabels tot max. 6,5mm diameter</li> </ul> |
|--|---|--|



Wei matt Blanc dépoli Wit mat

EAN 4000870 924969  
**924.96** **new**



Alu gedreht Alu tourné Alu gedraaid

EAN 4000870 924976  
**924.97** **new**

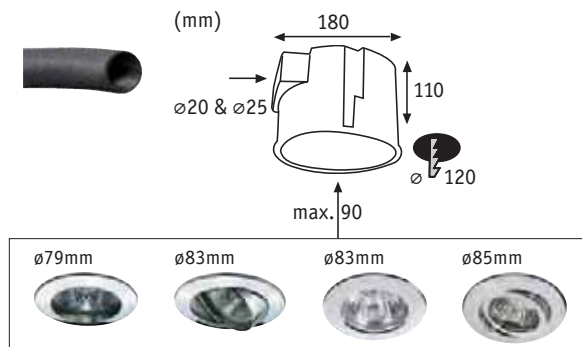

**Einbautopf**  
**Couvercle encastré**  
**Inbouwpot**

☒ Kunststoff Matière plastique Kunststoff

- |   |  |  |
|---|--|--|
| <ul style="list-style-type: none"> <li>▶ Luftdicht = blower door geeignet (0,21m<sup>3</sup>/(hxm)+-10%)</li> <li>▶ Anschluss für Wellrohre 20 + 25 mm</li> <li>▶ Zusätzliche Kabeleinführung</li> <li>▶ Trafoausschnitt entnehmbar</li> <li>▶ Mittelpunktermittlung mit Magnet möglich</li> <li>▶ Feuerhemmend 850°C getestet</li> </ul> | <ul style="list-style-type: none"> <li>▶ Hermétique = convient au test blower door (0,21m<sup>3</sup>/(hxm)+-10%)</li> <li>▶ Raccordement pour tubes ondulés 20 + 25 mm</li> <li>▶ Entrée de câbles supplémentaire</li> <li>▶ Section de transformateur amovible</li> <li>▶ Possibilité de repérage du point central avec aimant</li> <li>▶ Résistance au feu testée jusqu'à 850 °C</li> </ul> | <ul style="list-style-type: none"> <li>▶ Luchtdicht = geschikt voor blower door (0,21m<sup>3</sup>/(hxm)+-10%)</li> <li>▶ Aansluiting voor golfbuis 20 + 25 mm</li> <li>▶ Extra kabelinvoering</li> <li>▶ Trafouitsnede uitneembaar</li> <li>▶ Middelpuntbepaling met magneet mogelijk</li> <li>▶ Brandvertragend 850° C getest</li> </ul> |
|---|--|--|



👉 Grau Gris Grijs

**max. 35 W**

EAN 4000870 002506

**250** ⚡

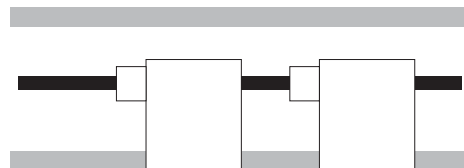

**Einbautopf**  
**Couvercle encastré**  
**Inbouwpot**

☒ Metall Métal Metaal

👉 Schwarz Noir Zwart

**max. 35 W**

12 V  
EAN 4000870 002308  
**230** ⚡

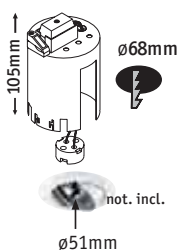

👉 Schwarz Noir Zwart

**max. 35 W**

230 V  
EAN 4000870 002360  
**236** ⚡

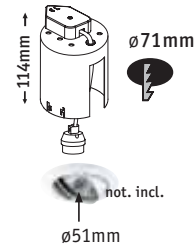

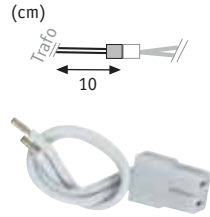

**Adapter für Trafos mit Klemmanschluss (2x1,5mm<sup>2</sup>)**  
**Adaptateur pour transformateur avec arrêt de traction (2x1,5mm<sup>2</sup>)**  
**Adapter voor trafo's met klemaansluiting (2x1,5mm<sup>2</sup>)**

max. 150 W  
 12 V  
 EAN 4000870 979853  
**979.85**

Halogen 12V



**12V, G4, GX5,3, GY6,35, GU5,3, GU4**

max. 50 W, G4 / GX5,3 / GY6,35  
 12 V  
 ⌀170 ↔15 ↗15 mm  
 EAN 4000870 002162  
**216**

Halogen 12V

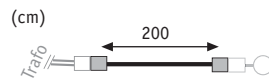

**200cm (2x0,75mm<sup>2</sup>)**

max. 105 W  
 12 V  
 0,75 mm<sup>2</sup> ↔2 m  
 EAN 4000870 979839  
**979.83**

Halogen 12V

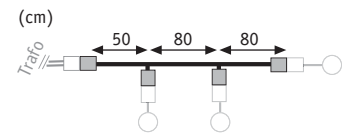

**210cm (2x0,75mm<sup>2</sup>)**

max. 3x35 W  
 12 V  
 0,75 mm<sup>2</sup> ↔2,1 m  
 EAN 4000870 979730  
**979.73**

Halogen 12V



**12V, G4, GX5,3, GY6,35, GU5,3, GU4**

max. 75 W, G4 / GX5,3 / GY6,35  
 12 V  
 EAN 4000870 021897  
**218.9**

Halogen 12V

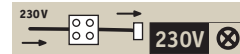

**230V GU10, GZ10**

GU10, GZ10  
 230 V  
 EAN 4000870 002179  
**217**



**230V GU10 Box**

max. 50 W, GU10  
 230 V  
 ⌀23 ↔70 ↗35 mm  
 EAN 4000870 938102  
**938.10**

Halogen 230V

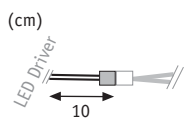
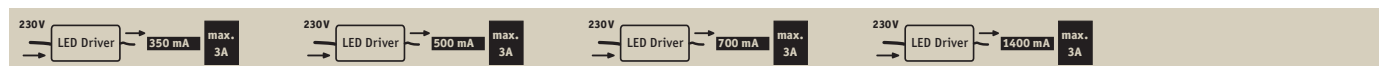

Adapter JST 1x0,1m, 350, 500, 700, 1000mA (2x0,5mm<sup>2</sup>)

⇔0,1m  
EAN 4000870 002285  
228

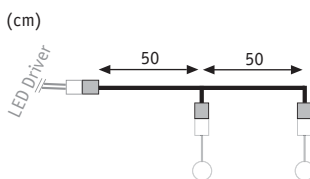

Adapter JST 1x1m, 350, 500, 700, 1000, 1400mA (2x0,5mm<sup>2</sup>)

⇔1m  
EAN 4000870 002292  
229

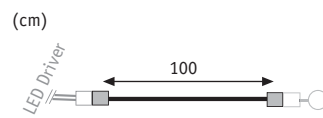

Adapter JST 1x1m, 350, 500, 700, 1000, 1400mA (2x0,5mm<sup>2</sup>)

⇔1m  
EAN 4000870 002339  
233



Sprenging (Kunststoff)  
Circlips (matière plastique)  
Veerring (Kunststof)



EAN 4000870 000205  
202000223



EAN 4000870 000212  
202000224



EAN 4000870 000274  
404001963

Sprenging (Metall)  
Circlips (Métal)  
Veerring (Metaal)



ø35 mm  
EAN 4000870 000267  
404000753



ø51 mm  
EAN 4000870 000250  
404000752



ø35 mm  
EAN 4000870 000243  
404000126



ø51 mm  
EAN 4000870 000236  
404000125



3x  
ø35 mm  
EAN 4000870 938058  
938.05



3x  
ø51 mm  
EAN 4000870 937617  
937.61



3x  
ø35 mm  
EAN 4000870 938065  
938.06



3x  
ø51 mm  
EAN 4000870 937624  
937.62



# Smart Home

- 400 Bluetooth Low Energy
- 402 ZigBee
- 404 Smart Friends

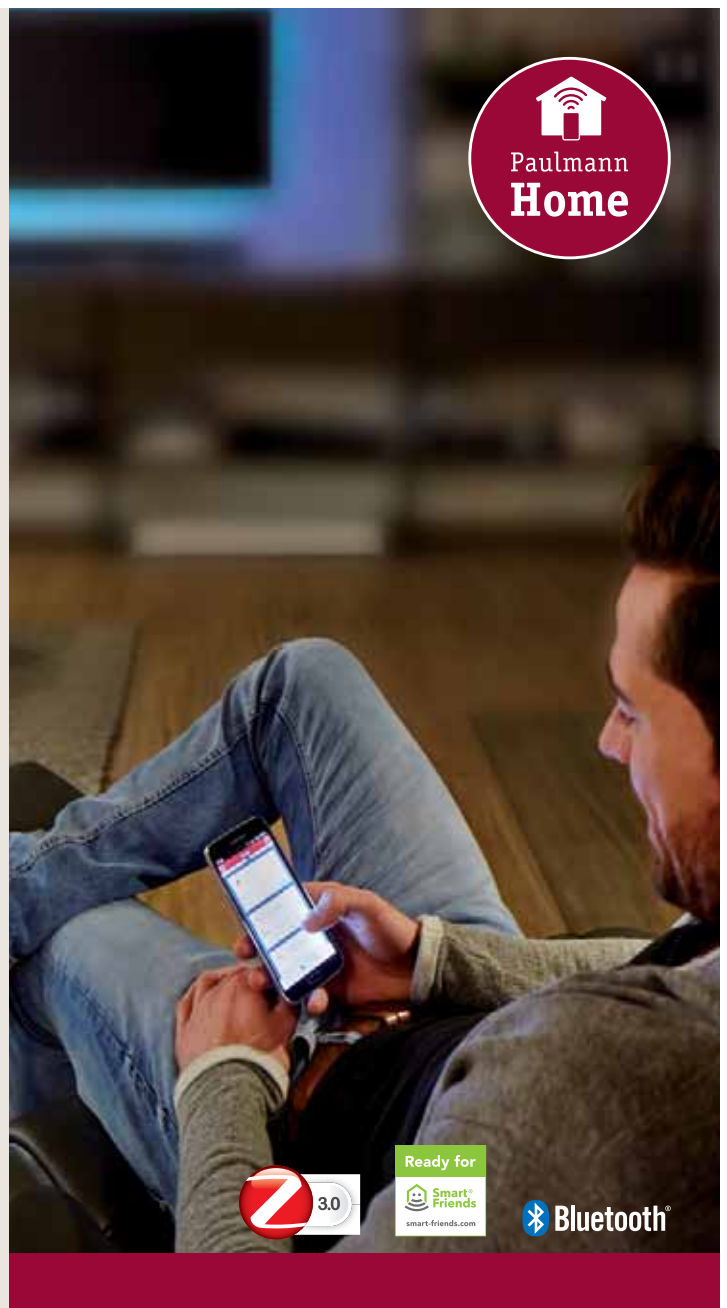

Lichtsteuerung

Commande d'éclairage

Lichtbesturing

Lichtsteuerung  
plus Gebäudesteuerung

Commande d'éclairage  
avec commande de bâtiment

Lichtbesturing  
plus gebouwbesturing

Gebäudesteuerung  
inkl. Lichtsteuerung

Commande de bâtiments  
avec commande d'éclairage

Gebouwbesturing  
incl. lichtbesturing

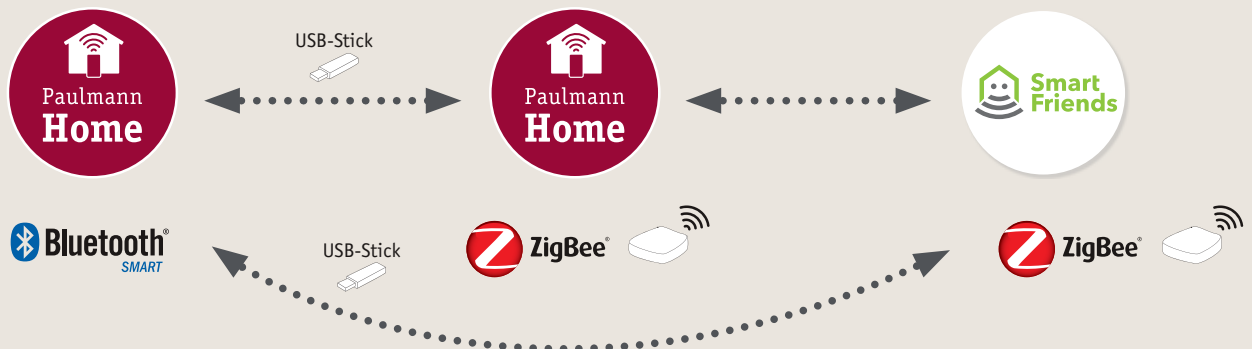

*Eine App für alle Funktionen*  
*Une application pour toutes les fonctions*  
*Een app voor alle functies*

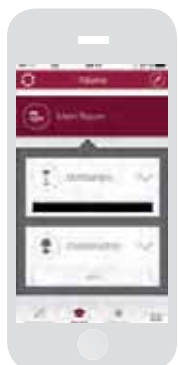

#### Räume

Legen Sie ganz individuell Räume an und ordnen Sie Ihre Leuchten den Räumen zu.

#### Pièces

Concevez des pièces de manière totalement individuelle et disposez vos luminaires en fonction de celles-ci.

#### Ruimtes

Maak geheel individueel ruimtes aan en deel uw armaturen bij deze ruimtes in.



#### Leuchten, Lampen, Controller

Legen Sie jede Ihrer Leuchten so an wie Sie es wollen – mit Namen und Symbol.

#### Luminaires, ampoules, contrôleur

Disposez vos luminaires comme vous le souhaitez - avec nom et symbole.

#### Armaturen, lampen, controller

Maak elk van uw armaturen aan zoals u zelf wilt – met een naam en symbol.



#### Farbsteuerung

Ob RGB+W-Effektlicht, tunable White oder einfach nur Dimmen, tauchen Sie Ihren Raum in die richtige Stimmung.

#### Contrôle de la couleur

Qu'il s'agisse d'effet lumineux RGB+W, de Tunable White ou simplement d'intensité variable, plongez votre pièce dans la bonne ambiance.

#### Kleurbesturing

Dompel uw ruimte in de juiste sfeer: met RGB+W-effectlicht, tunable white of gewoon dimmen.

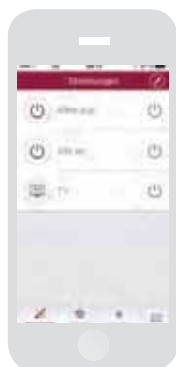

#### Szenen

Mit ihren Lieblingseinstellungen können Sie jederzeit auf Knopfdruck alles so einstellen, wie Sie es bevorzugen.“

#### Scénarios

Vos paramètres favoris vous permettent à tout moment de tout régler selon vos préférences, par simple pression sur un bouton.

#### Scènes

Via uw favoriete instellingen kunt u te allen tijde met één druk op de knop alles precies instellen, zoals u het verkiest.



#### Favoriten

Jede Leuchte können Sie als Favorit anlegen, um diese schnell bedienen zu können.

#### Favoris

Vous pouvez ajouter n'importe quel luminaire à vos favoris afin de le retrouver plus rapidement.

#### Favorieten

Iedere armatuur kunt u als favoriet aanmaken, om deze snel te kunnen bedienen.



#### Zeitsteuerung

Bestimmen Sie selbst, zu welcher Uhrzeit Ihre Leuchte automatisch an- bzw. ausgeschaltet werden soll.

Zum Schaltzeitpunkt muss das Smartphone nicht in der Nähe sein.

#### Synchronisation

Définissez vous-même à quelle heure les luminaires doivent être allumés ou éteints.

À l'heure de l'activation, la proximité du smartphone n'est pas nécessaire.

#### Tijdbesturing

Bepaal zelf op welk tijdstip uw armatuur automatisch moet worden in- of uitgeschakeld.

Op het schakeltijdstip hoeft uw smartphone niet in de buurt te zijn.











Weitere Produkte im jeweiligen Kapitel.

You will find other products in the respective sections.

Meer producten in het overeenkomstige hoofdstuk.



 **Bluetooth®**

Wohnraumleuchten Éclairages domestiques Woonkamerlampen	☞= 10, 15, 81, 86	
Spotlights	☞= 121-122	
Wire Systems	☞= 126, 129-130	
Rail Systems	☞= 157, 171-172	
Function	☞= 178-179, 190, 205-206	
Downlights	☞= 356, 358-359	
LED-Leuchtmittel Ampoules LED LED-lampen	☞= 449	











**Remote Control Boss**

AAA/1,5V (Micro) × 2  
 ⌀18 ⇄48 ↗110 mm  
 EAN 4000870 500019





**500.01** 

-  Schwarz  Kunststoff
-  Noir  Matière plastique
-  Zwart  Kunststof

**EuroPlug Switch**

max. 400 W  
 230 V  
 Ω max. 400 W, C max. 75 W, I max. 75 W  
 ⌀103 ⇄62 ↗47 mm  
 EAN 4000870 500194

**500.19** 

-  Weiß  Kunststoff
-  Blanc  Matière plastique
-  Wit  Kunststof

**EuroPlug Switch/Dimm**

max. 300 W  
 230 V  
 Ω max. 300 W, I max. 100 W  
 ⌀103 ⇄62 ↗47 mm  
 EAN 4000870 500200

**500.20** 

-  Weiß  Kunststoff
-  Blanc  Matière plastique
-  Wit  Kunststof



**Master Switch**

max. 500 W  
 220-240 V  
 Ω max. 500 W, C max. 75 W, I max. 75 W  
 ⌀26 ⇄47 ↗136 mm  
 EAN 4000870 500170

**500.17** 

-  Weiß  Kunststoff
-  Blanc  Matière plastique
-  Wit  Kunststof

**Master Switch/Dimm**

max. 300 W  
 220-240 V  
 Ω max. 300 W, I max. 100 W  
 ⌀26 ⇄47 ↗136 mm  
 EAN 4000870 500187

**500.18** 

-  Weiß  Kunststoff
-  Blanc  Matière plastique
-  Wit  Kunststof









Weitere Produkte im jeweiligen Kapitel.

You will find other products in the respective sections.

Meer producten in het overeenkomstige hoofdstuk.



Wohnraumleuchten Éclairages domestiques Woonkamerlampen	📖= 11. 92	
Spotlights	📖= 122-123	
Rail Systems	📖= 171	
Function	📖= 190, 205, 207	
Outdoor	📖= 262	
Downlights	📖= 360-362	
LED-Leuchtmittel Ampoules LED LED-lampen	📖= 450	



- ▶ Zum Schalten, Dimmen und Einstellung der RGB-Farbtöne oder Tunable White.
- ▶ Aktoren lassen sich einzeln oder in Gruppen steuern.
- ▶ Wird Gent Remote control am Gateway angelernt, können darüber auch vielfältige Lichtszenen aktiviert werden.

- ▶ Pour la commutation, la gradation et le réglage des tonalités RGB ou Tunable White
- ▶ Les actionneurs peuvent être commandés individuellement ou en groupes.
- ▶ Avec l'apprentissage de contrôle à distance Gent sur la passerelle, de nombreux scénarios d'éclairage peuvent être activés.

- ▶ Voor het schakelen, dimmen en instellen van de RGB-kleuren of tunable white.
- ▶ Actuatoren kunnen apart of in groepen worden bestuurd.
- ▶ Indien Gent Remote control aan de gateway wordt aangeleerd, kunnen daarmee ook talrijke lichtscènes worden geactiveerd.



#### Gent Remote Control

AAA/1,5V (Micro) × 2  
230V  
∅18 ↔55 ↗138 mm  
EAN 4000870 500675  
**500.67**



- ↳ Schwarz Kunststoff
- ↳ Noir Matière plastique
- ↳ Zwart Kunststof

- ▶ Zigbee 3.0 Dimm Controller zum smarten Nachrüsten von Schaltern, Tastern oder Drehdimmern (mit Tastfunktion) zur Steuerung von dimmbaren Verbrauchern bis 400W ohmsch bzw. 75W induktiv/kapazitiv
- ▶ Der Dimm Controller wird direkt an den vorhandenen Schalter etc. angeschlossen werden und sendet oder empfängt Zigbee 3.0 Steuerungssignale
- ▶ Für den Einbau in Hohlwanddosen geeignet

- ▶ Controller var. Zigbee 3.0 pour l'équipement intelligent en deuxième monte de commutateurs, touches ou variateurs rotatifs (avec fonction tactile) et commander des appareils électriques gradables jusqu'à 400W ohmiques ou 75 W inductifs/capacitifs
- ▶ Le contrôleur de variation d'intensité est raccordé directement au commutateur existant et émet ou reçoit des signaux de commande Zigbee 3.0
- ▶ Convient à une installation dans des prises pour cloisons creuses.

- ▶ Zigbee 3.0 dimcontroller om achteraf schakelaars, knoppen of draaidimmers (met toetsfunctie) voor de besturing van dimbare verbruikers tot 400W ohms of 75W inductief/capacitief slim uit te rusten
- ▶ De dim controller wordt rechtstreeks op een bestaande schakelaar enz. aangesloten en zendt of ontvangt Zigbee 3.0 besturingssignalen
- ▶ Geschikt voor de inbouw in spouwmuurdozen

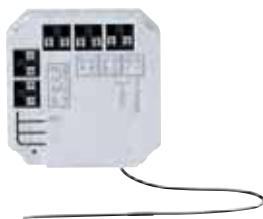

#### Recessed Dimm Controller

max. 400W  
230V  
Ω max. 400W, C max. 75W, I max. 75W  
∅48 ↔48 ↗20 mm  
EAN 4000870 500941  
**500.94 new**



- ↳ Weiß Kunststoff
- ↳ Blanc Matière plastique
- ↳ Wit Kunststof

- ▶ Zigbee 3.0 Schalter Controller zum smarten Nachrüsten von Serien-Wandschalter
- ▶ Für Verbraucher bis 500W ohmsch bzw. 75W induktiv/kapazitiv
- ▶ Der Schalter Controller kann direkt an einen Serien-Wandschalter angeschlossen werden und sendet oder empfängt Zigbee 3.0 Steuerungssignale
- ▶ Für den Einbau in Hohlwanddosen geeignet

- ▶ Contrôleur commutateur Zigbee 3.0 pour l'équipement intelligent en deuxième monte des interrupteurs muraux de série.
- ▶ Pour appareils électriques jusqu'à 500W résistives ou 75W inductive/capacitive
- ▶ Le contrôleur de commutateur peut être raccordé directement à une prise mural de série et émet ou reçoit des signaux de commande Zigbee 3.0
- ▶ Convient à une installation dans des prises pour cloisons creuses.

- ▶ Zigbee 3.0 schakelaarcontroller om achteraf serie-muurschakelaars slim uit te rusten.
- ▶ Voor verbruikers tot 500W ohms of 75W inductief/capacitief
- ▶ De schakelaarcontroller kan rechtstreeks op een serie-muurschakelaar worden aangesloten en zendt of ontvangt Zigbee 3.0 besturingssignalen
- ▶ Geschikt voor de inbouw in spouwmuurdozen

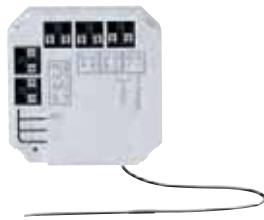

#### Recessed Serial Switch Controller

max. 500/500 W  
230 V  
Ω max. 500 W, C max. 75 W, I max. 75 W  
⌀48 ↔48 ↗20 mm  
EAN 4000870 500958  
**500.95 new**



🏠 Weiß 🧱 Kunststoff  
🏠 Blanc 🧱 Matière plastique  
🏠 Wit 🧱 Kunststof

- ▶ Zigbee 3.0 Steckdosen Controller zum smarten Nachrüsten von Schuko-Steckdosen
- ▶ Für Verbraucher bis 1000W
- ▶ Der Steckdosen Controller wird direkt am Steckdosen-Einsatz angeschlossen und empfängt Zigbee 3.0 Steuerungssignale
- ▶ Für den Einbau in Hohlwanddosen geeignet

- ▶ Contrôleur de prises Zigbee 3.0 pour l'équipement intelligent en deuxième monte des prises Schuko.
- ▶ Pour appareils électriques jusqu'à 1000W
- ▶ Le contrôleur de prises se branche directement sur la prise et reçoit les signaux de commande Zigbee 3.0.
- ▶ Convient à une installation dans des prises pour cloisons creuses.

- ▶ Zigbee 3.0 contactdooscontroller om achteraf veiligheidscontactdozen slim uit te rusten
- ▶ Voor verbruikers tot 1000W
- ▶ De contactdooscontroller wordt rechtstreeks op de contactdoos aangesloten en ontvangt Zigbee 3.0 besturingssignalen
- ▶ Geschikt voor de inbouw in spouwmuurdozen



#### Recessed Socket Controller

max. 1.000 W  
230 V  
Ω max. 1.000 W, C max. 75 W, I max. 75 W  
⌀48 ↔48 ↗20 mm  
EAN 4000870 501030  
**501.03 new**



🏠 Weiß 🧱 Kunststoff  
🏠 Blanc 🧱 Matière plastique  
🏠 Wit 🧱 Kunststof



#### Cephei Switch

max. 1.000 W  
230 V  
Ω max. 1.000 W, C max. 75 W, I max. 75 W  
⌀53 ↔163 ↗60 mm  
EAN 4000870 500439  
**500.43 new**



#### Cephei Switch/ Dimm

max. 400 W  
230 V  
Ω max. 400 W, C max. 150 W,  
⌀53 ↔163 ↗60 mm  
EAN 4000870 500446  
**500.44 new**



🏠 Weiß/Grau 🧱 Kunststoff  
🏠 Blanc/Gris 🧱 Matière plastique  
🏠 Wit/Grijs 🧱 Kunststof



#### Smart-Friends-kompatibel

Profitieren Sie mit Smart Friends von einem zukunftssicheren und erweiterbaren System von vier miteinander kompatiblen deutschen Qualitätsherstellern:

- ▶ Sicherheitstechnik und WLAN Außenkamera von ABUS
- ▶ ZigBee- und Bluetooth-Innenleuchten von Paulmann
- ▶ Antriebstechnik für Rollläden und Garagentore oder Heizungsthermostate von Schellenberg
- ▶ Sensortechnik und Leuchten von STEINEL

Sie können alle Produkte einzeln nutzen, sie untereinander verknüpfen und zudem Aktionen automatisieren. Die Steuerung aller Produkte erfolgt über die Smart-Friends-App auf dem Smartphone oder Tablet.

#### Compatible Smart Friends

Avec Smart Friends bénéficiez du système durable et extensible de quatre fabricants de produits de qualité allemands compatibles entre eux :

- ▶ Technologie de sécurité et caméra extérieure WLAN de ABUS
- ▶ Éclairages intérieurs ZigBee et Bluetooth de Paulmann
- ▶ Technologie d'entraînement pour volets roulants et portes de garage ou Thermostats de chauffage de Schellenberg
- ▶ Technologie de capteurs et luminaires du fabricant STEINEL

Vous pouvez utiliser tous les produits séparément, ou bien les connecter entre eux et même automatiser des actions. Tous les produits sont commandés par l'application Smart Friends sur smartphone ou tablette.

#### Compatibel met Smart Friends

Profiteer met Smart Friends van een toekomstgericht en uitbreidbaar systeem van vier compatibele Duitse kwaliteitsfabrikanten:

- ▶ Veiligheidstechniek en WLAN-buitencamera van ABUS
- ▶ ZigBee- en bluetooth-binnenverlichting van Paulmann
- ▶ Aandrijftechniek voor rolluiken en garagepoorten of Thermostaten van Schellenberg
- ▶ Sensortechniek en armaturen van STEINEL

U kunt alle producten apart bedienen, ze met elkaar verbinden en ook acties automatiseren. De besturing van alle producten gebeurt via de Smart-Friends-app op de smartphone of tablet.



#### Smart Friends Box

30x140x140 mm  
EAN 4000870 500668  
**500.66**

- ☑ Weiß ☑ Kunststoff
- ☑ Blanc ☑ Matière plastique
- ☑ Wit ☑ Kunststof





Ihr Haus verschreckt den Einbrecher automatisch!



Lassen Sie sich von Ihrem Haus wecken!



Schaffen Sie vom Sofa aus eine gemütliche Atmosphäre!



Ihr Haus erwartet Sie bereits, wenn Sie am Abend heimkehren!

Votre maison décourage automatiquement les voleurs !

Confiez à votre maison le soin de vous réveiller !

Créez une atmosphère agréable sans quitter votre canapé !

Votre maison est déjà prête à vous accueillir lorsque vous rentrez le soir !

Uw huis schrikt inbrekers automatisch af!

Laat u door uw huis wakken!

Creëer vanaf uw bank een gezellige sfeer!

Uw huis verwacht u al, wanneer u 's avonds thuiskomt!



Smart Friends vereint Lösungen aus den Bereichen Licht, Sicherheit, Heizungssteuerung und Antriebstechnik.

Smart Friends conjugue des solutions issues des secteurs de l'éclairage, de la sécurité, de la régulation du chauffage et de la technologie d'entraînement.

Smart Friends combineert oplossingen op het gebied van licht, veiligheid, verwarmingsregeling en aandrijftechniek.



**Ihre Daten sind sicher!**

Bei Smart Friends steht Datenschutz an erster Stelle. Smart Friends garantiert Ihnen den höchsten Schutz Ihrer Daten dank lokaler Datenspeicherung auf der Box – ganz ohne Daten in einer Cloud.

**Vos données sont sécurisées !**

Chez Smart Friends la protection des données est notre priorité absolue. Smart Friends vous garantit une protection maximale de vos données grâce à leur stockage local dans la box. Aucune donnée n'est stockée sur un Cloud.

**Uw gegevens zijn veilig!**

Bij Smart Friends staat gegevensbescherming op de eerste plaats. Smart Friends garandeert u maximale bescherming van uw gegevens dankzij de lokale gegevensopslag op de box – helemaal zonder gegevens in een cloud.

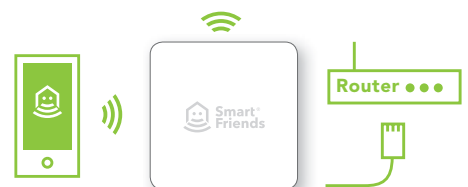





**VDE Disc Transformer 230/12V**



- ▶ Disctrafos passen durch kreisrunde Bohrlöcher
- ▶ Dimmbar mit allen Dimmern (Phasen- und -abschnitt)
- ▶ Les transformateurs Disctrafos sont adaptés à la forme circulaire des alésages
- ▶ Possibilité de variation crépusculaire avec tous les gradateurs (découpage début et fin de phase)
- ▶ Disc-trafo's passen door de cirkelvormige boorgaten
- ▶ Dimbaar met alle dimmers (fase aan- en afsnijding)



**230/12V, 70VA**

max. 20-70 W  
 ⌀23 ⌀55 mm  
 EAN 4000870 977286  
**977.28**



**230/12V, 105VA**

max. 35-105 W  
 ⌀25 ⌀75 mm  
 EAN 4000870 977293  
**977.29**



**VDE Mipro Transformer 230/12V**



- ▶ Miprotrafos sind auf minimale Abmessungen konzipiert, sie passen in kleinste Montageräume
- ▶ Ideal für Einbauleuchten
- ▶ Einsetzbar bis zu 50° Umgebungstemperatur
- ▶ Dimmbar mit allen Dimmern (Phasen- und -abschnitt)
- ▶ Les transformateurs Miprotrafos aux dimensions réduites sont spécialement conçus pour les espaces de montages étroits
- ▶ Convient aux luminaires encastrés
- ▶ Supporte une température ambiante max. de 50°
- ▶ Possibilité de variation crépusculaire avec tous les gradateurs (découpage début et fin de phase)
- ▶ Miprotrafo's zijn ontworpen voor minimale afmetingen, ze passen in de kleinste montage ruimtes
- ▶ Ideaal voor inbouw lampen
- ▶ Te gebruiken tot een omgevingstemperatuur van 50°
- ▶ Dimbaar met alle dimmers (fase aan- en afsnijding)



**230/12V, 70VA**

max. 20-70 W  
 ⌀23 ⇄36 ⌀127 mm  
 EAN 4000870 977514  
**977.51**



**230/12V, 105VA**

max. 35-105 W  
 ⌀30 ⇄38 ⌀137 mm  
 EAN 4000870 977538  
**977.53**



**VDE Profi Transformer 230/12V**



- ▶ Einsetzbar bis zu 50° Umgebungstemperatur
- ▶ Für geringe Mindestlast 10 W geeignet
- ▶ Dimmbar mit allen Dimmern (Phasen- und -abschnitt)
- ▶ Supporte une température ambiante max. de 50°
- ▶ Adapté à une charge minimale de 10 W
- ▶ Possibilité de variation crépusculaire avec tous les gradateurs (découpage début et fin de phase)
- ▶ Te gebruiken tot een omgevingstemperatuur van 50°
- ▶ Geschikt voor geringe belasting van ten minste 10 W
- ▶ Dimbaar met alle dimmers (fase aan- en afsnijding)



**230/12V, 50VA**

max. 10-50 W  
 ⌀19 ⇄36 ⌀77 mm  
 EAN 4000870 977361  
**977.36**



### VDE Flat Transformer 230/12V

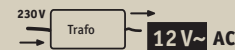

- |   |  |  |
|---|--|--|
| <ul style="list-style-type: none"> <li>▶ Flattrafos brauchen eine Einbauhöhe von nur 24 mm</li> <li>▶ Problemlöser bei gering abgehängten Decken</li> <li>▶ Ideal für Spiegel-, Galerialuchten und im Möbelbau</li> <li>▶ Dimmbar mit allen Dimmern (Phasen- und -abschnitt)</li> </ul> | <ul style="list-style-type: none"> <li>▶ Dimension réduite des transformateurs plats Flattrafos à 24 mm</li> <li>▶ Solution aux faux plafonds étroits</li> <li>▶ Convient parfaitement aux luminaires pour miroirs, Galeria et ameublement</li> <li>▶ Possibilité de variation crépusculaire avec tous les gradateurs (découpage début et fin de phase)</li> </ul> | <ul style="list-style-type: none"> <li>▶ Flattrafo's hebben een inbouwhoogte van slechts 24 mm</li> <li>▶ Probleemoplossing voor verlaagde plafonds met te weinig tussenruimte</li> <li>▶ Ideaal voor spiegelverlichting, Galerialampen en voor inbouw in meubels</li> <li>▶ Dimbaar met alle dimmers (fase aan- en afsnijding)</li> </ul> |
|---|--|--|



**230/12V, 70 VA**  
 max. 20-70 W  
 ⚡24 ↔50 ↻147 mm  
 EAN 4000870 977811  
**977.81**

**230/12V, 105 VA**  
 max. 35-105 W  
 ⚡24 ↔50 ↻147 mm  
 EAN 4000870 977828  
**977.82**



### VDE Profi Transformer 230/12V



- |  |  |  |
|--|--|--|
| <ul style="list-style-type: none"> <li>▶ Doppelter Primäranschluss für mehrere Trafos in einer Schaltung</li> <li>▶ Mehrere Sekundärklemmenpaare</li> <li>▶ Bis 50 °C Umgebungstemperatur</li> <li>▶ NYM-Kabel geeignet</li> <li>▶ Unverlierbare Zugentlastung und Kappe</li> <li>▶ Mittelauslass</li> <li>▶ Dimmbar mit allen Dimmern (Phasen- und -abschnitt)</li> </ul> | <ul style="list-style-type: none"> <li>▶ Raccordement primaire double pour plusieurs transformateurs dans un circuit</li> <li>▶ Plusieurs paires de bornes secondaires</li> <li>▶ Supporte une température ambiante max. de 50 °</li> <li>▶ À utiliser avec un câble NYM</li> <li>▶ Décharge de traction et capuchon imperdables</li> <li>▶ Source de courant centrale</li> <li>▶ Possibilité de variation crépusculaire avec tous les gradateurs (découpage début et fin de phase)</li> </ul> | <ul style="list-style-type: none"> <li>▶ Dubbele primaire aansluiting voor meerdere trafo's in een schakeling</li> <li>▶ Meerdere secundaire klemmenparen</li> <li>▶ Tot een omgevingstemperatuur van 50 °</li> <li>▶ Geschikt voor NYM-kabels</li> <li>▶ Geborgde trekentlasting en kap</li> <li>▶ Uitlaat in het midden</li> <li>▶ Dimbaar met alle dimmers (fase aan- en afsnijding)</li> </ul> |
|--|--|--|



**230/12V, 80 VA**  
 max. 20-80 W  
 ⚡27 ↔39 ↻161 mm  
 EAN 4000870 977712  
**977.71**

**230/12V, 105 VA**  
 max. 35-105 W  
 ⚡27 ↔39 ↻161 mm  
 EAN 4000870 977019  
**977.01**



**230/12V, 150 VA**  
 max. 50-150 W  
 ⚡40 ↔48 ↻190 mm  
 EAN 4000870 977156  
**977.15**



**230/12V, 200 VA**  
 max. 100-200 W  
 ⚡44 ↔51 ↻222 mm  
 EAN 4000870 977200  
**977.20**

**230/12V, 250 VA**  
 max. 100-250 W  
 ⚡44 ↔51 ↻222 mm  
 EAN 4000870 977255  
**977.25**



**Halo + LED Trafo 230/12V AC**



- ▶ Für Halogen und LED
- ▶ Keine Mindestlast
- ▶ Dimmbar mit Phasenabschnittsdimmern
- ▶ Pour halogène et LED
- ▶ Aucune charge minimale
- ▶ Gradable avec gradateur à découpage de phase
- ▶ Voor halogeen en LED
- ▶ Geen minimumlast
- ▶ Dimbaar met faseafsnijdingsdimmern



**220-240/12V, 50 VA**

max. 0-50 W  
 ⌀28 ⇄44 ↗127 mm  
 EAN 4000870 977620  
**977.62**

**220-240/12V, 65 VA**

max. 0-65 W  
 ⌀28 ⇄44 ↗127 mm  
 EAN 4000870 977675  
**977.67**



LED = 415-418  
 977.62 max. 30W  
 977.67 max. 40W



12V = 457-460  
 977.62 max. 50W  
 977.67 max. 65W



**Spice Transformer 230/12V**



- Chrom matt
- Metall
- Chrome mat Métal
- Chroom mat
- Metaal



**230/12V, 300VA**

max. 300 W  
 ⌀80 ⇄205 ↗205 mm  
 EAN 4000870 972786  
**972.78**

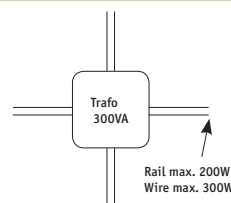

**Toroidal Decorative Transformer 230/12V**



- Chrom Kunststoff
- Chrome
- Matière plastique
- Chroom Kunststof



**230/12V, 80VA**

max. 80 W  
 ⌀86 ø145 mm  
 EAN 4000870 979327  
**979.32**

**230/12V, 105VA**

max. 105 W  
 ⌀86 ø145 mm  
 EAN 4000870 979419  
**979.41**



**230/12V, 150VA**

max. 150 W  
 ⌀92 ø174 mm  
 EAN 4000870 979433  
**979.43**



**230/12V, 200VA**

max. 200 W  
 ⌀100 ø189 mm  
 EAN 4000870 979457  
**979.45**

**230/12V, 300VA**

max. 300 W  
 ⌀100 ø189 mm  
 EAN 4000870 979464  
**979.46**



**LED Power Supply 12W 230/12V DC**



- ▶ Speziell für den LED-Betrieb konzipiert
- ▶ 230 V 50 Hz / 12 V DC
- ▶ Pilotes sont spécialement conçus pour le fonctionnement LED
- ▶ 230 V 50 Hz / 12 V DC
- ▶ Drivers zijn speciaal ontworpen voor LED-bedrijf
- ▶ 230 V 50 Hz / 12 V DC



**230/12V, 12VA**

max. 12 W  
 ⌀19 ⇄39 ↗122 mm  
 EAN 4000870 987544  
**987.54**

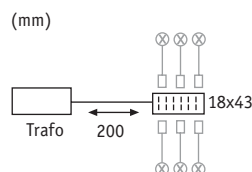

**Power Supply 230/12V DC**



- ▶ Für vielfältige Systemanwendungen
- ▶ Für YourLED und YourLED ECO
- ▶ Pour des applications système diversifiées
- ▶ Pour YourLED et YourLED ECO
- ▶ Voor veelvoudige systeemtoepassingen
- ▶ Voor YourLED en YourLED ECO



**230/12V, 15 VA**

max. 15 W  
 ⌀18 ⇄125 ⌀40 mm  
 EAN 4000870 701997  
**701.99**



**230/12V, 48 VA**

max. 48 W  
 ⌀40 ⇄135 ⌀55 mm  
 EAN 4000870 702000  
**702.00**



for YourLED Strip  
 □ = 191-221



**Power Supply 60W 230/12V DC IP65**

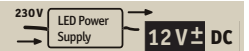

- ▶ Für vielfältige Systemanwendungen
- ▶ Für YourLED und YourLED ECO
- ▶ Beonders geeignet für den Einsatz in Feuchträumen.
- ▶ Pour des applications système diversifiées
- ▶ Pour YourLED et YourLED ECO
- ▶ Utilisation idéale dans les pièces humides.
- ▶ Voor veelvoudige systeemtoepassingen
- ▶ Voor YourLED en YourLED ECO
- ▶ Bijzonder geschikt voor gebruik in vochtige ruimtes.



**230/12V, 60 VA**

max. 60 W  
 ⌀40 ⇄225 ⌀60 mm  
 EAN 4000870 702017  
**702.01**



for YourLED Strip  
 □ = 191-221



**Power Supply 230/24V DC**



- ▶ Für vielfältige Systemanwendungen
- ▶ Für MaxLED
- ▶ Pour des applications système diversifiées
- ▶ Pour MaxLED
- ▶ Voor veelvoudige systeemtoepassingen
- ▶ Voor MaxLED



**230/24V, 36 VA**

max. 36 W  
 ⌀24 ⇄166 ⌀52 mm  
 EAN 4000870 708231  
**708.23**



**230/24V, 60 VA**

max. 60 W  
 ⌀35 ⇄175 ⌀54 mm  
 EAN 4000870 708248  
**708.24**



for MaxLED Strip  
 □ = 175-190



**LED Driver 350mA const. 10W max. 35V DC**

- ▶ Driver sind speziell für den LED-Betrieb konzipiert
- ▶ 350 mA Konstantstrom
- ▶ Pilotes sont spécialement conçus pour le fonctionnement LED
- ▶ Courant constant 350 mA
- ▶ Drivers zijn speciaal ontworpen voor LED-bedrijf
- ▶ 350 mA constante stroom

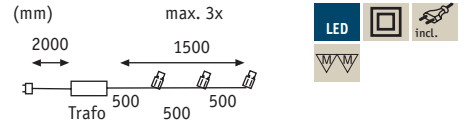

**230V, 10VA**  
 max. 10W  
 ⌀30 ⇄50 ⇄110 mm  
 EAN 4000870 975381  
**975.38** ➡

**LED-Driver Disc 350mA 9W max. 34V DC**

- ▶ Driver sind speziell für den LED-Betrieb konzipiert
- ▶ 350 mA Konstantstrom
- ▶ Pilotes sont spécialement conçus pour le fonctionnement LED
- ▶ Courant constant 350 mA
- ▶ Drivers zijn speciaal ontworpen voor LED-bedrijf
- ▶ 350 mA constante stroom



**230V, 9VA**  
 max. 9W  
 ⌀24 ø52 mm  
 EAN 4000870 977385  
**977.38** ➡

**LED-Driver Disc 700mA 12W max. 16V**

- ▶ Driver sind speziell für den LED-Betrieb konzipiert
- ▶ 700 mA Konstantstrom
- ▶ Pilotes sont spécialement conçus pour le fonctionnement LED
- ▶ Courant constant 700 mA
- ▶ Drivers zijn speciaal ontworpen voor LED-bedrijf
- ▶ 700 mA constante stroom



**230V, 12VA**  
 max. 12W  
 ⌀24 ø52 mm  
 EAN 4000870 977378  
**977.37** ➡

**LED Driver 700mA 3W max. 5V DC**

- ▶ Driver sind speziell für den LED-Betrieb konzipiert
- ▶ 700 mA Konstantstrom
- ▶ Pilotes sont spécialement conçus pour le fonctionnement LED
- ▶ Courant constant 700 mA
- ▶ Drivers zijn speciaal ontworpen voor LED-bedrijf
- ▶ 700 mA constante stroom



**230V, 3VA**  
 max. 3W  
 ⌀22 ⇄28 ⇄38 mm  
 EAN 4000870 977033  
**977.03** ➡



**LED Driver dimmable 350 mA**



- ▶ Driver sind speziell für den LED-Betrieb konzipiert
- ▶ 350 mA Konstantstrom
- ▶ Dimmbar mit allen Dimmern (Phasen- und -abschnitt)
- ▶ Pilotes sont spécialement conçus pour le fonctionnement LED
- ▶ Courant constant 350 mA
- ▶ Possibilité de variation crépusculaire avec tous les gradateurs (découpage début et fin de phase)
- ▶ Drivers zijn speciaal ontworpen voor LED-bedrijf
- ▶ 350 mA constante stroom
- ▶ Dimbaar met alle dimmers (fase aan- en afsnijding)



**230V, 7-9 VA**  
 max. 9 W  
 ⌀24 ⇄41 ↗119 mm  
 EAN 4000870 977231  
**977.23**

**230V, 8-12 VA**  
 max. 12 W  
 ⌀24 ⇄41 ↗119 mm  
 EAN 4000870 977248  
**977.24**

**230V, 10-15 VA**  
 max. 15 W  
 ⌀24 ⇄41 ↗119 mm  
 EAN 4000870 977262  
**977.26**



**230V, 15-20 VA**  
 max. 20 W  
 ⌀26 ⇄43 ↗143 mm  
 EAN 4000870 977606  
**977.60**



**LED Driver dimmable 700 mA**



- ▶ Driver sind speziell für den LED-Betrieb konzipiert
- ▶ 700 mA Konstantstrom
- ▶ Dimmbar mit allen Dimmern (Phasen- und -abschnitt)
- ▶ Pilotes sont spécialement conçus pour le fonctionnement LED
- ▶ Courant constant 700 mA
- ▶ Possibilité de variation crépusculaire avec tous les gradateurs (découpage début et fin de phase)
- ▶ Drivers zijn speciaal ontworpen voor LED-bedrijf
- ▶ 700 mA constante stroom
- ▶ Dimbaar met alle dimmers (fase aan- en afsnijding)



**230V, 7-9 VA**  
 max. 9 W  
 ⌀24 ⇄41 ↗119 mm  
 EAN 4000870 977279  
**977.27**

**230V, 9-12 VA**  
 max. 12 W  
 ⌀24 ⇄41 ↗119 mm  
 EAN 4000870 977392  
**977.39**



**230V, 13-18 VA**  
 max. 18 W  
 ⌀26 ⇄43 ↗143 mm  
 EAN 4000870 977347  
**977.34**

**230V, 18-25 VA**  
 max. 25 W  
 ⌀26 ⇄43 ↗143 mm  
 EAN 4000870 977330  
**977.33**

**230V, 21-30 VA**  
 max. 30 W  
 ⌀26 ⇄43 ↗143 mm  
 EAN 4000870 977323  
**977.32**



**LED Driver 350 mA**



**230 V, 1-4 VA**  
 max. 4 W  
 ⌀19 ⇄39 ⇄80 mm  
 EAN 4000870 977446  
**977.44**



**230 V, 3,5-7 VA**  
 max. 7 W  
 ⌀23 ⇄38 ⇄80 mm  
 EAN 4000870 977453  
**977.45**



**230 V, 7-15 VA**  
 max. 15 W  
 ⌀18 ⇄49 ⇄103 mm  
 EAN 4000870 977439  
**977.43**



**230 V, 14-25 VA**  
 max. 25 W  
 ⌀22 ⇄43 ⇄126 mm  
 EAN 4000870 977460  
**977.46**



**LED Driver 700 mA**



**230 V, 2-7 VA**  
 max. 7 W  
 ⌀18 ⇄38 ⇄79 mm  
 EAN 4000870 977477  
**977.47**



**230 V, 6-15 VA**  
 max. 15 W  
 ⌀18 ⇄39 ⇄122 mm  
 EAN 4000870 977484  
**977.48**



**230 V, 13-25 VA**  
 max. 25 W  
 ⌀22 ⇄43 ⇄126 mm  
 EAN 4000870 977491  
**977.49**



**230 V, 19,5-42 VA**  
 max. 42 W  
 ⌀30 ⇄43 ⇄137 mm  
 EAN 4000870 977507  
**977.50**



### LED Transformier 230/12V AC



▶ 230 V 50 Hz / 12 V AC 50 Hz

▶ 230 V 50 Hz / 12 V AC 50 Hz

▶ 230 V 50 Hz / 12 V AC 50 Hz



#### 230/12V, 20VA

max. 20 W  
 ⌀53 ⇄58 ↗87 mm  
 EAN 4000870 977590  
**977.59**

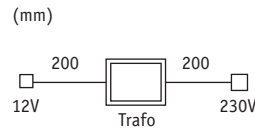

LED □ = 415-418



### Outdoorbox IP65



⌀102 ⇄146 ↗240 mm  
 EAN 4000870 988473  
**988.47**

- ↳ Schwarz □ Alu
- ↳ Noir □ Alu
- ↳ Zwart □ Alu



### PIR-Sensor 230V

- ▶ Näherungsschalter für die An-/Aus-Schaltung der LED-Strips und anderer Produkte
- ▶ Max. 75 W (magnetische Trafos)
- ▶ Max. 60 W (elektronische Last)
- ▶ Max. 250 W (Glühlampen)

- ▶ Interrupteur de proximité Marche/Arrêt des rubans LED et autres produits
- ▶ Max. 75 W (transformateurs magnétiques)
- ▶ Max. 60 W (charge électronique)
- ▶ Max. 250 W (ampoules à incandescence)

- ▶ Naderingsschakelaar voor het in-/uitschakelen van de LED-stripes en andere producten
- ▶ Max. 75 W (magnetische trafo's)
- ▶ Max. 60 W (elektronische last)
- ▶ Max. 250 W (gloeilampen)



#### 230V

max. 60 W  
 ⌀19 ⌀17,5 ⇄85 ↗36 mm  
 EAN 4000870 704516  
**704.51**

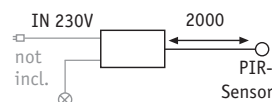
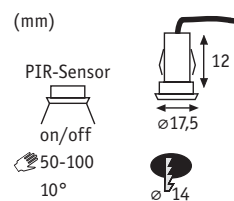



# LED-Leuchtmittel

## Ampoules LED

### LED-lampen

- 416 LED/Coin
- 417 LED/12V
- 418 LED/230V



#### Lumenvergleich

#### Comparaison des lumens

#### Lumenvergelijking

Lichttechnik  
Technologie d'éclairage  
Lichttechniek

(Glüh-) Lampe Watt  
Ampoule (à incandescence) Watt  
(Gloeilamp watt

LED Helligkeit in Lumen  
Luminosité LED en lumens  
LED-helderheid in lumen

Rundumstrahler  
Omnidirectionnels  
Rondomstralers



Glühlampe Klassik Ampoule à incandescence classique Gloeilamp klassiek		15 W	140 lm
		25 W	250 lm
		40 W	470 lm
		60 W	806 lm
		75 W	1055 lm
		100 W	1521 lm
<b>E14, E27, GU10</b>			
Halogen 230V G9, E27, R7s		25 W	250 lm
		40 W	470 lm
		60 W	806 lm
Halogen 12V		5 W	45 lm
		10 W	90 lm
		20 W	190 lm
		35 W	390 lm
		50 W	630 lm
<b>G4, GY6,35</b>			

Reflektorlampen  
Lampes à réflecteur  
Reflectorlampen

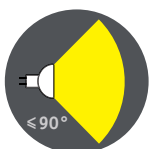

Halogen 230V E14, E27, GU10		25 W	125 lm
		35 W	200 lm
		50 W	300 lm
Halogen 12V		10 W	80 lm/90 lm (GU4/GU5,3)
		20 W	160 lm/180 lm (GU4/GU5,3)
		35 W	300 lm
		50 W	540 lm
<b>GU4, GU5,3</b>			



**Klar Clair Helder**

W	⊖	∅ mm	⇅ mm	◁	lm	cd	⚡	K	⌚	ON/OFF	📦	EAN	☑	
<b>incl. 6,8</b>		49,5	30	A <sup>+</sup>	544		38	2.700	30.000	15000	1	4000870 939482	✓	<b>939.48</b>

Premium Reflector Coin 230V



**Klar Clair Helder**

W	⊖	∅ mm	⇅ mm	◁	lm /90°	cd	⚡	K	⌚	ON/OFF	📦	EAN	☑	
<b>incl. 6,8</b>		49,5	40	A <sup>+</sup>	535		110	2.700	30.000	15000	1	4000870 938171	✓	<b>938.17</b>

LED Coin 51mm



**Satin Satiné Satijn**

W	⊖	∅ mm	⇅ mm	◁	lm /90°	cd	⚡	K	⌚	ON/OFF	📦	EAN	☑	
<b>incl. 6,8</b>		49,5	40	A <sup>+</sup>	535		110	2.700	30.000	15000	1	4000870 938195	✓	<b>938.19</b>
<b>incl. 6,8</b>		49,5	40	A <sup>+</sup>	470		160	6.500	30.000	15000	1	4000870 938324	✓	<b>938.32</b>

LED Coin 51mm



**Klar Clair Helder**

W	⊖	∅ mm	⇅ mm	◁	lm	cd	⚡	K	⌚	ON/OFF	📦	EAN	☑	
<b>incl. 7</b>		49,5	35	A	482		110	2.700	30.000	15000	1	4000870 938355	✓	<b>938.35</b>

LED Coin 51mm



**Satin Satiné Satijn**

W	⊖	∅ mm	⇅ mm	◁	lm /120°	cd	⚡	K	⌚	ON/OFF	📦	EAN	☑	
<b>incl. 7</b>		49,5	35	A	482		105	2.700	30.000	15000	1	4000870 938362	✓	<b>938.36</b>
<b>incl. 7</b>		49,5	35	A <sup>+</sup>	633		105	4.000	30.000	15000	1	4000870 938379	✓	<b>938.37</b>

LED Coin 51mm



**Satin Satiné Satijn**

W	⊖	∅ mm	⇅ mm	◁	lm	cd	⚡	K	⌚	ON/OFF	📦	EAN	☑	
<b>incl. 6,8</b>		50	30	A	592		120	2.700	30.000	15000	1	4000870 938843	✓	<b>938.84</b>
<b>incl. 6,8</b>		50	30	A	633		120	2.700	30.000	15000	1	4000870 938850	✓	<b>938.85</b>
<b>incl. 6,8</b>		50	35	A <sup>+</sup>	640		110	4.000	30.000	15000	1	4000870 936665	✓	<b>new 936.66</b>

LED Coin 51mm



Wei Blanc Wit

W	⊖	∅ mm	⇅ mm	◻	lm	cd	⚡	K	⌚	ON/OFF	📦	EAN	☑	
1,3	G4	22	31	A++	90			2.700	15.000	50000	10	4000870 282878	☑	282.87



Wei Blanc Wit

W	⊖	∅ mm	⇅ mm	◻	lm	cd	⚡	K	⌚	ON/OFF	📦	EAN	☑	
2,5	G4	30	42	A+	180			2.700	15.000	50000	10	4000870 282755	☑	282.75



Wei Blanc Wit

W	⊖	∅ mm	⇅ mm	◻	lm	cd	⚡	K	⌚	ON/OFF	📦	EAN	☑	
1	G4	15	31	A++	85			3.000	10.000	40000	10	4000870 280911	☑	280.91



Klar Clair Helder

W	⊖	∅ mm	⇅ mm	◻	lm	cd	⚡	K	⌚	ON/OFF	📦	EAN	☑	
2	G4	14	37	A+	140			2.700	15.000	50000	10	4000870 283363	☑	283.36

3 VA



Wei Blanc Wit

W	⊖	∅ mm	⇅ mm	◻	lm	cd	⚡	K	⌚	ON/OFF	📦	EAN	☑	
2,5	G4	15	42	A+	170			2.700	15.000	50000	10	4000870 282762	☑	282.76
3x2,5	G4	15	42	A+	170			2.700	15.000	50000	1	4000870 284315	☑	new 284.31

3 VA



Wei Blanc Wit

W	⊖	∅ mm	⇅ mm	◻	lm	cd	⚡	K	⌚	ON/OFF	📦	EAN	☑	
2,5	GY6,35	15	38	A+	170			2.700	15.000	50000	10	4000870 282779	☑	282.77

3 VA



Alu Alu Alu

W	⊖	∅ mm	⇅ mm	◻	lm <sub>/90°</sub>	cd	⚡	K	⌚	ON/OFF	📦	EAN	☑	
4	GU4	35	40	A	200	550	30	2.700	15.000	50000	10	4000870 282601	☑	282.60

5 VA

- ▶ Maxiflood
- ▶ Strahlt gleichmssig rundum in alle Richtungen (ideal fr farbige Lampenschirme)

- ▶ Maxiflood
- ▶ Rayonne uniformment dans toutes les directions (idal pour les abat-jour de couleur)

- ▶ Maxiflood
- ▶ Straalt gelijkmatig rondom in alle richtingen (optimaal voor gekleurde lampenschermen)



Maxiflood



Softopal Soft-opale Softopaal

W	⊖	∅ mm	⇅ mm	◻	lm	cd	⚡	K	⌚	ON/OFF	📦	EAN	☑	
1,8	GU4	35	33	A+	100			2.700	15.000	50000	10	4000870 283295	☑	283.29

2 VA

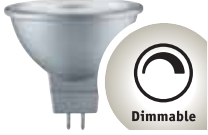

Alu Alu Alu 



W	⊖	∅ mm	⇅ mm	◻	lm	cd	⚡	K	⌚	ON/OFF 		EAN	✓	
4,5	GU5,3	51	46	A+	345			2.700	25.000	50000	10	4000870 284650	✓	284.65
5 VA														
6,5	GU5,3	51	46	A+	460			2.700	25.000	50000	10	4000870 284667	✓	284.66
7 VA														



Alu Alu Alu



W	⊖	∅ mm	⇅ mm	◻	lm/90°	cd	⚡	K	⌚	ON/OFF 		EAN	✓	
4	GU5,3	50	49	A+	230	500	38	2.700	20.000	50000	7	4000870 283011	✓	283.01
5,5 VA														

Silber Argent Zilver





W	⊖	∅ mm	⇅ mm	◻	lm/90°	cd	⚡	K	⌚	ON/OFF 		EAN	✓	
1	GU5,3	51	45	A+	35	170	20	3.000	10.000	10000	10	4000870 280492	✓	280.49
1	GU5,3	51	45	A+	35	170	20	6.500	10.000	10000	10	4000870 280003	✓	280.00

- ▶ Maxiflood
- ▶ Strahlt gleichmäßig rundum in alle Richtungen (ideal für farbige Lampenschirme)
- ▶ Maxiflood
- ▶ Rayonne uniformément dans toutes les directions (idéal pour les abat-jour de couleur)
- ▶ Maxiflood
- ▶ Straalt gelijkmatig rondom in alle richtingen (optimaal voor gekleurde lampenschermen)



Softopal Soft-opale Softopaal





W	⊖	∅ mm	⇅ mm	◻	lm	cd	⚡	K	⌚	ON/OFF 		EAN	✓	
3	GU5,3	51	45	A+	220			2.700	15.000	50000	10	4000870 283301	✓	283.30
4 VA														

Maxiflood

Diamond Diamond Diamond



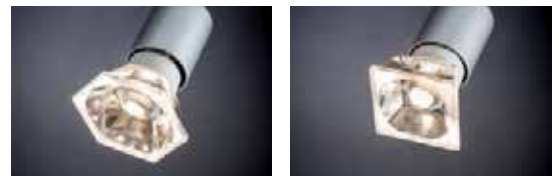

W	⊖	∅ mm	⇅ mm	◻	lm	cd	⚡	K	⌚	ON/OFF 		EAN	✓	
3	GU5,3	45	50	A+	250			2.700	15.000	50000	1	4000870 283264	✓	283.26
4,5 VA														

Hexa



Diamond Diamond Diamond





W	⊖	∅ mm	⇅ mm	◻	lm	cd	⚡	K	⌚	ON/OFF 		EAN	✓	
3	GU5,3	37	50	A+	250			2.700	15.000	50000	1	4000870 283257	✓	283.25
4,5 VA														

Quadro

Alu Alu Alu



W	⊖	∅ mm	⇅ mm	◻	lm/120°	cd	⚡	K	⌚	ON/OFF 		EAN	✓	
8	G53	111	56	A+	500	2.100	24	2.700	15.000	50000	1	4000870 285152	✓	285.15
10,5 VA														

AR 111



## Klar Clair Helder



W	⊖	∅ mm	⇅ mm	◻	lm	cd	✂	K	⌚	ON/OFF	📦	EAN	☑	
3	G9	16	50	A++	300			2.700	15.000		10	4000870 284469	✓	284.46

## Klar Clair Helder



W	⊖	∅ mm	⇅ mm	◻	lm	cd	✂	K	⌚	ON/OFF	📦	EAN	☑	
2	G9	14	48	A++	200			2.700	15.000	50000	10	4000870 285336	✓	new 285.33

3x2	G9	14	48	A++	200			2.700	15.000	50000	10	4000870 285350	✓	new 285.35
-----	----	----	----	-----	-----	--	--	-------	--------	-------	----	----------------	---	------------



## Klar Clair Helder

W	⊖	∅ mm	⇅ mm	◻	lm	cd	✂	K	⌚	ON/OFF	📦	EAN	☑	
2,2	G9	15	50	A++	200			2.700	20.000	50000	10	4000870 283387	✓	283.38



## Klar Clair Helder

W	⊖	∅ mm	⇅ mm	◻	lm	cd	✂	K	⌚	ON/OFF	📦	EAN	☑	
1,5	G9	18	45	A++	100			2.700	15.000	50000	10	4000870 281796	✓	281.79



## Klar Clair Helder

W	⊖	∅ mm	⇅ mm	◻	lm	cd	✂	K	⌚	ON/OFF	📦	EAN	☑	
1,5	G9	14	46	A+	90			2.700	25.000	50000	15	4000870 283424	✓	283.42



## Opal Opale Opaal

W	⊖	∅ mm	⇅ mm	◻	lm	cd	✂	K	⌚	ON/OFF	📦	EAN	☑	
3x2,4	G9	18	54	A+	180			2.700	15.000	50000	1	4000870 284322	✓	new 284.32

2x2,4	G9	18	54	A+	180			2.700	25.000	50000	15	4000870 282908	✓	282.90
-------	----	----	----	----	-----	--	--	-------	--------	-------	----	----------------	---	--------

2,4	G9	18	54	A+	180			2.700	25.000	50000	15	4000870 283431	✓	283.43
-----	----	----	----	----	-----	--	--	-------	--------	-------	----	----------------	---	--------



## Klar Clair Helder

W	⊖	∅ mm	⇅ mm	◻	lm	cd	✂	K	⌚	ON/OFF	📦	EAN	☑	
3x2,4	G9	17	54	A++	210			2.700	20.000	50000	10	4000870 285107	✓	285.10

2,4	G9	17	54	A++	210			2.700	20.000	50000	10	4000870 285091	✓	285.09
-----	----	----	----	-----	-----	--	--	-------	--------	-------	----	----------------	---	--------



## Klar Clair Helder

W	⊖	∅ mm	⇅ mm	◻	lm	cd	✂	K	⌚	ON/OFF	📦	EAN	☑	
3	G9	30	75	A++	250			3.000	15.000	50000	10	4000870 281123	✓	281.12



Klar Clair Helder

W	⊖	∅ mm	↑ mm	□	lm	cd	✂	K	⌚	ON/OFF	📦	EAN	☑	
3	GU10	30	70	A <sup>+</sup>	250			2.700	15.000	100000	10	4000870 282243	✓	282.24



Deco Pipe

Satin Satiné Satijn

W	⊖	∅ mm	↑ mm	□	lm	cd	✂	K	⌚	ON/OFF	📦	EAN	☑	
5	GU10	30	125	A <sup>+</sup>	490			2.700	15.000	50000	10	4000870 284186	✓	284.18

Alu Alu Alu



W	⊖	∅ mm	↑ mm	□	lm <sub>/90°</sub>	cd	✂	K	⌚	ON/OFF	📦	EAN	☑	
5,5	GU10	51	54	A <sup>+</sup>	345	900	36	2.700	25.000	50000	10	4000870 284636	✓	284.63
7	GU10	51	54	A <sup>+</sup>	460	800	36	2.700	25.000	50000	10	4000870 284643	✓	284.64

Alu Alu Alu



W	⊖	∅ mm	↑ mm	□	lm <sub>/90°</sub>	cd	✂	K	⌚	ON/OFF	📦	EAN	☑	
3,5	GU10	51	54	A <sup>+</sup>	230	550	38	2.700	20.000	50000	7	4000870 282991	✓	282.99
3x3,5	GU10	51	54	A <sup>+</sup>	230	550	38	2.700	15.000	50000	10	4000870 284292	✓	new 284.29
6,5	GU10	51	54	A <sup>+</sup>	425	950	38	2.700	20.000	50000	7	4000870 283004	✓	283.00
3x6,5	GU10	51	54	A <sup>+</sup>	425	950	38	2.700	15.000	50000	10	4000870 284308	✓	new 284.30

Silber Argent Zilver



W	⊖	∅ mm	↑ mm	□	lm <sub>/90°</sub>	cd	✂	K	⌚	ON/OFF	📦	EAN	☑	
3,7	GU10	51	53	A <sup>+</sup>	230	500	36	2.700	15.000	50000	10	4000870 284339	✓	284.33
5,7	GU10	51	53	A <sup>+</sup>	350	650	36	2.700	15.000	50000	10	4000870 284346	✓	284.34

Glas Verre Glas



W	⊖	∅ mm	↑ mm	□	lm <sub>/90°</sub>	cd	✂	K	⌚	ON/OFF	📦	EAN	☑	
3,2	GU10	51	53	A <sup>+</sup>	230	500	36	2.700	15.000	50000	10	4000870 284094	✓	284.09
5,3	GU10	51	53	A <sup>+</sup>	345	650	36	2.700	15.000	50000	10	4000870 284100	✓	284.10



🔗 Diamond Diamond Diamond

W	⊖	∅ mm	⇅ mm	◻	lm /90°	cd	⚡	K	🕒	ON/OFF	📦	EAN	📄	
3	GU10	51	52	A+	250	450	45	2.700	15.000	50000	10	4000870 282854	✓	282.85



🔗 Diamond Diamond Diamond

W	⊖	∅ mm	⇅ mm	◻	lm /90°	cd	⚡	K	🕒	ON/OFF	📦	EAN	📄	
3	GU10	51	80	A+	250	450	45	2.700	15.000	50000	10	4000870 283554	✓	283.55

Long neck

- ▶ Maxiflood
- ▶ Maxiflood
- ▶ Maxiflood
- ▶ Strahlt gleichmäßig rundum in alle Richtungen (ideal für farbige Lampenschirme)
- ▶ Rayonne uniformément dans toutes les directions (idéal pour les abat-jour de couleur)
- ▶ Straalt gelijkmatig rondom in alle richtingen (optimaal voor gekleurde lampenschermen)



🔗 Softopal Soft-opale Softopaal



Maxiflood

W	⊖	∅ mm	⇅ mm	◻	lm	cd	⚡	K	🕒	ON/OFF	📦	EAN	📄	
3,5	GU10	51	53	A+	250			2.700	15.000	50000	10	4000870 282861	✓	282.86
3,5	GU10	51	52	A+	250			2.700	15.000	50000	10	4000870 285367	✓	new 285.36

🔗 Silber Argent Zilver



W	⊖	∅ mm	⇅ mm	◻	lm /90°	cd	⚡	K	🕒	ON/OFF	📦	EAN	📄	
1	GU10	51	55	A+	35	150	20	3.000	10.000	10000	10	4000870 280485	✓	280.48
1	GU10	51	55	A+	35	170	20	6.500	10.000	10000	10	4000870 280119	✓	280.11



🔗 Alu Alu Alu

W	⊖	∅ mm	⇅ mm	◻	lm /90°	cd	⚡	K	🕒	ON/OFF	📦	EAN	📄	
3,5	GU10	51	53	A+	200	800	24	2.700	20.000	50000	10	4000870 282199	✓	282.19



Rot Rouge Rood



W	⊖	∅ mm	⇅ mm	◻	lm <sub>/90°</sub>	cd	✂	K	⌚	ON/OFF		EAN	✓	
1	GU10	51	55	A	18		20		10.000		10	4000870 280072	✓	280.07



Grün Vert Groen



W	⊖	∅ mm	⇅ mm	◻	lm	cd	✂	K	⌚	ON/OFF		EAN	✓	
3,5	GU10	51	53	A+	200		25		20.000		10	4000870 282540	✓	282.54



Blau Bleu Blauw



W	⊖	∅ mm	⇅ mm	◻	lm <sub>/90°</sub>	cd	✂	K	⌚	ON/OFF		EAN	✓	
1	GU10	51	52	A	18		20		10.000		10	4000870 280102	✓	280.10



Alu Alu Alu

QPAR 111

W	⊖	∅ mm	⇅ mm	◻	lm <sub>/90°</sub>	cd	✂	K	⌚	ON/OFF		EAN	✓	
4	GU10	111	70	A++	350	1.150	24	2.700	15.000	50000	1	4000870 285145	✓	285.14







R50

Warmweiß Blanc chaud Warmwit

W	⊖	∅ mm	⇅ mm	◻	lm/90°	cd	✂	K	⌚	ON/OFF	📦	EAN	☑	
3,5	E14	50	84	A+	230	460	36	2.700	15.000	50000	8	4000870 284605	✓	284.60



R63

Warmweiß Blanc chaud Warmwit

W	⊖	∅ mm	⇅ mm	◻	lm/90°	cd	✂	K	⌚	ON/OFF	📦	EAN	☑	
5	E27	63	95	A+	370	960	36	2.700	15.000	50000	6	4000870 284612	✓	284.61



R80

Opal Opale Opaal

W	⊖	∅ mm	⇅ mm	◻	lm/120°	cd	✂	K	⌚	ON/OFF	📦	EAN	☑	
10	E27	80	114	A+	806		110	2.700	25.000	50000	5	4000870 284445	✓	284.44



PAR38

Klar Clair Helder

W	⊖	∅ mm	⇅ mm	◻	lm/90°	cd	✂	K	⌚	ON/OFF	📦	EAN	☑	
10	E27	121	136	A+	900	3.400	25	2.700	25.000	50000	3	4000870 284452	✓	284.45



DECOR CRI > 90



R63 Plant light

Wachstumslicht Pousse-plante Groeilicht

W	⊖	∅ mm	⇅ mm	◻	lm/90°	cd	✂	K	⌚	ON/OFF	📦	EAN	☑	
4,5	E27	63	102	A	180	700	30	4.000	15.000	50000	6	4000870 283417	✓	283.41



🎵 Multicolor Multicolor Multicolor



W	⊖	∅ mm	⇅ mm	□	lm	cd	✂	K	⌚	ON/OFF [ ]	📦	EAN	☑	
3,5	E27	74	148						3.000		1	4000870 284704	✓	284.70



🎵 Multicolor Multicolor Multicolor



W	⊖	∅ mm	⇅ mm	□	lm	cd	✂	K	⌚	ON/OFF [ ]	📦	EAN	☑	
1,5	E27	80	150						3.000		1	4000870 284711	✓	284.71



🎵 Multicolor Multicolor Multicolor



W	⊖	∅ mm	⇅ mm	□	lm	cd	✂	K	⌚	ON/OFF [ ]	📦	EAN	☑	
3,5	E27	74	150						3.000		1	4000870 285510	✓	new 285.51



🎵 Multicolor Multicolor Multicolor



W	⊖	∅ mm	⇅ mm	□	lm	cd	✂	K	⌚	ON/OFF [ ]	📦	EAN	☑	
3,5	E27	74	150						3.000		1	4000870 285527	✓	new 285.52



PIR

Opal Opale Opaal



120°  
5m  
< 30Lux  
≈ 60 sec



W	⚡	∅ mm	↑ mm	◻	lm	cd	⚡	K	⌚	ON/OFF	📦	EAN	✓	
6,5	E27	60	126	A+	470			2.700	15.000	50000	6	4000870 284728	✓	284.72



► Whiteswitch - durch mehrfaches Drücken des Wandschalters ist die Farbtemperatur einstellbar

► Whiteswitch - Diverses températures de couleur sont possibles en appuyant plusieurs fois sur l'interrupteur mural

► Whiteswitch - de kleurtemperatuur is instelbaar door meerdere keren op de muerschakelaar te drukken

1x click  
● 2700 K

2x click  
● 4000 K

3x click  
● 6500 K



Opal Opale Opaal

W	⚡	∅ mm	↑ mm	◻	lm	cd	K	⌚	ON/OFF	📦	EAN	✓	
8,5	E27	60	120	A+	806		2.700 - 6.500	25.000	50000	10	4000870 285206	✓	new 285.20



Opal Opale Opaal



W	⚡	∅ mm	↑ mm	◻	lm	cd	⚡	K	⌚	ON/OFF	📦	EAN	✓	
3,5	E27	45	83	B	75			15.000	50000	6	4000870 285183	✓	285.18	



Opal Opale Opaal



W	⚡	∅ mm	↑ mm	◻	lm	cd	⚡	K	⌚	ON/OFF	📦	EAN	✓	
3,5	E14	35	99	B	75			15.000	50000	6	4000870 285176	✓	285.17	





## Opal Opale Opaal



W	⊖	∅ mm	⇅ mm	◻	lm	cd	✂	K	⌚	ON/OFF	📦	EAN	☑	
6	E27	60	112	A <sup>+</sup>	470			2.700	25.000	50000	10	4000870 283509	☑	283.50
10	E27	62	116	A <sup>+</sup>	806			2.700	25.000	50000	10	4000870 283493	☑	283.49
10	E27	62	116	A <sup>+</sup>	806			6.500	25.000	50000	10	4000870 283486	☑	283.48

## Opal Opale Opaal



W	⊖	∅ mm	⇅ mm	◻	lm	cd	✂	K	⌚	ON/OFF	📦	EAN	☑	
6,5	E27	60	110	A <sup>+</sup>	470			2.700	20.000	50000	6	4000870 282977	☑	282.97
3x6,5	E27	60	110	A <sup>+</sup>	470			2.700	15.000	50000	1	4000870 284285	☑	new 284.28
9,5	E27	60	110	A <sup>+</sup>	806			2.700	20.000	50000	6	4000870 282984	☑	282.98
3x9	E27	60	112	A <sup>+</sup>	806			2.700	15.000	50000	10	4000870 285329	☑	new 285.32
13	E27	60	117	A <sup>+</sup>	1.521			2.700	15.000	50000	1	4000870 283981	☑	283.98
W	⊖	∅ mm	⇅ mm	◻	lm	cd	✂	K	⌚	ON/OFF	📦	EAN	☑	
7	E27	60	110	A <sup>+</sup>	470			6.500	20.000	50000	6	4000870 282441	☑	282.44
11	E27	60	110	A <sup>+</sup>	806			6.500	20.000	50000	6	4000870 282458	☑	282.45

*Dekorative LED-Lampen – Filament und Vollglas*  
*Ampoules LED décoratives – Filament et verre plein*  
*Decoratieve LED-lampen – filament en glas*



## Klar Clair Helder



W	⊖	∅ mm	⇅ mm	◻	lm	cd	✂	K	⌚	ON/OFF	📦	EAN	☑	
7,5	E27	60	104	A <sup>+</sup>	806			2.700	15.000	50000	6	4000870 284230	☑	284.23



## Klar Clair Helder

W	⊖	∅ mm	⇅ mm	◻	lm	cd	✂	K	⌚	ON/OFF	📦	EAN	☑	
11	E27	70	126	A <sup>++</sup>	1.521			2.700	15.000	50000	6	4000870 285435	☑	new 285.43



Klar Clair Helder

W	⊖	∅ mm	↑ mm	□	lm	cd	⚡	K	⌚	ON/OFF	📦	EAN	☑	
2x4	E27	60	104	A++	470			2.700	15.000	50000	10	4000870 284759	✓	284.75



W	⊖	∅ mm	↑ mm	□	lm	cd	⚡	K	⌚	ON/OFF	📦	EAN	☑	
5	E27	60	104	A+	470			2.700	15.000	50000	6	4000870 283783	✓	283.78
7,5	E27	60	104	A+	806			2.700	15.000	50000	6	4000870 283776	✓	283.77



Opal Opale Opaal

W	⊖	∅ mm	↑ mm	□	lm	cd	⚡	K	⌚	ON/OFF	📦	EAN	☑	
4,5	E27	55	93	A+	430			2.700	20.000	50000	6	4000870 283325	✓	283.32

W	⊖	∅ mm	↑ mm	□	lm	cd	⚡	K	⌚	ON/OFF	📦	EAN	☑	
6	E27	60	108	A+	550			2.700	20.000	50000	6	4000870 283318	✓	283.31



Gold Doré Goud

W	⊖	∅ mm	↑ mm	□	lm	cd	⚡	K	⌚	ON/OFF	📦	EAN	☑	
5	E27	60	104	A+	380			2.500	15.000	50000	6	4000870 283745	✓	283.74

7,5	E27	60	104	A+	550			2.500	15.000	50000	6	4000870 283738	✓	283.73
-----	-----	----	-----	----	-----	--	--	-------	--------	-------	---	----------------	---	--------



Kopfspiegel Silber Calotte argentée Kopfspiegel silber

W	⊖	∅ mm	↑ mm	□	lm	cd	⚡	K	⌚	ON/OFF	📦	EAN	☑	
5	E27	60	104	A+	380			2.700	15.000	50000	6	4000870 283769	✓	283.76

7,5	E27	60	104	A+	550			2.700	15.000	50000	6	4000870 283752	✓	283.75
-----	-----	----	-----	----	-----	--	--	-------	--------	-------	---	----------------	---	--------



Kopfspiegel Kupfer Calotte réfléchissante en cuivre Kopfspiegel koper

W	⊖	∅ mm	↑ mm	□	lm	cd	⚡	K	⌚	ON/OFF	📦	EAN	☑	
7,5	E27	60	104	A+	680			2.700	15.000	50000	6	4000870 284568	✓	284.56



Rot Rouge Rood



W	⊖	∅ mm	⇅ mm	◻	lm	cd	✂	K	⌚	ON/OFF	📦	EAN	☑	
1	E27	60	104	A+	20				15.000		6	4000870 284483	✓	284.48



Grün Vert Groen



W	⊖	∅ mm	⇅ mm	◻	lm	cd	✂	K	⌚	ON/OFF	📦	EAN	☑	
1	E27	60	104	A+	25				15.000		6	4000870 284490	✓	284.49



Blau Bleu Blauw



W	⊖	∅ mm	⇅ mm	◻	lm	cd	✂	K	⌚	ON/OFF	📦	EAN	☑	
1	E27	60	104	A	10				15.000		6	4000870 284506	✓	284.50



Orange Orange Oranje



W	⊖	∅ mm	⇅ mm	◻	lm	cd	✂	K	⌚	ON/OFF	📦	EAN	☑	
1	E27	60	104	A+	25				15.000		6	4000870 284513	✓	284.51



Violett Violet Paars



W	⊖	∅ mm	⇅ mm	◻	lm	cd	✂	K	⌚	ON/OFF	📦	EAN	☑	
1	E27	60	104	B	5				15.000		6	4000870 284520	✓	284.52



## Opal Opale Opaal



W	⊖	∅ mm	⇅ mm	◻	lm	cd	✂	K	⌚	ON/OFF	📦	EAN	☑	
5,5	E14	36	110	A+	470			2.700	25.000	50000	10	4000870 283516	✓	283.51



## Opal Opale Opaal

W	⊖	∅ mm	⇅ mm	◻	lm	cd	✂	K	⌚	ON/OFF	📦	EAN	☑	
3x4	E14	35	100	A+	250			2.700	15.000	50000	1	4000870 284261	✓	new 284.26
3x5,5	E14	35	100	A+	470			2.700	15.000	50000	10	4000870 285381	✓	new 285.38



## Opal Opale Opaal

W	⊖	∅ mm	⇅ mm	◻	lm	cd	✂	K	⌚	ON/OFF	📦	EAN	☑	
4	E14	35	100	A+	250			2.700	20.000	50000	8	4000870 282915	✓	282.91
6	E14	37	100	A+	470			2.700	20.000	50000	8	4000870 282922	✓	282.92



## Opal Opale Opaal

W	⊖	∅ mm	⇅ mm	◻	lm	cd	✂	K	⌚	ON/OFF	📦	EAN	☑	
3,5	E14	35	102	A+	260			6.500	15.000	50000	8	4000870 283400	✓	283.40



## Klar Clair Helder

W	⊖	∅ mm	⇅ mm	◻	lm	cd	✂	K	⌚	ON/OFF	📦	EAN	☑	
2x2	E14	35	97	A++	250			2.700	15.000	50000	10	4000870 284742	✓	284.74



W	⊖	∅ mm	⇅ mm	◻	lm	cd	✂	K	⌚	ON/OFF	📦	EAN	☑	
2,5	E14	35	97	A+	250			2.700	15.000	50000	10	4000870 283639	✓	283.63



## Klar Clair Helder

W	⊖	∅ mm	⇅ mm	◻	lm	cd	✂	K	⌚	ON/OFF	📦	EAN	☑	
2,5	E14	35	126	A+	200			2.700	15.000	15000	8	4000870 281703	✓	281.70



## Satin Satiné Satijn

W	⊖	∅ mm	⇅ mm	◻	lm	cd	✂	K	⌚	ON/OFF	📦	EAN	☑	
2,5	E14	35	126	A+	200			2.700	15.000	15000	8	4000870 281710	✓	281.71



Opal Opale Opaal

W	⊖	∅ mm	⇅ mm	◻	lm	cd	✂	K	⌚	ON/OFF	📦	EAN	☑	
2,5	E14	35	97	A++	220			2.700	20.000	50000	8	4000870 283356	✓	283.35



Satin Satiné Satijn

W	⊖	∅ mm	⇅ mm	◻	lm	cd	✂	K	⌚	ON/OFF	📦	EAN	☑	
2,5	E14	35	97	A+	250			2.700	15.000	50000	10	4000870 283660	✓	283.66



Satin Satiné Satijn

W	⊖	∅ mm	⇅ mm	◻	lm	cd	✂	K	⌚	ON/OFF	📦	EAN	☑	
2,5	E14	35	123	A+	250			2.700	15.000	50000	10	4000870 283622	✓	283.62



Klar Clair Helder

W	⊖	∅ mm	⇅ mm	◻	lm	cd	✂	K	⌚	ON/OFF	📦	EAN	☑	
2,5	E14	35	97	A+	250			2.700	15.000	50000	10	4000870 283714	✓	283.71



Gold Doré Goud

W	⊖	∅ mm	⇅ mm	◻	lm	cd	✂	K	⌚	ON/OFF	📦	EAN	☑	
2,5	E14	35	97	A+	220			2.500	15.000	50000	10	4000870 283721	✓	283.72



Gold Doré Goud

W	⊖	∅ mm	⇅ mm	◻	lm	cd	✂	K	⌚	ON/OFF	📦	EAN	☑	
2,5	E14	35	97	A+	220			2.500	15.000	50000	10	4000870 283646	✓	283.64



Krokoeis gold Givré doré Craquelé goud

W	⊖	∅ mm	⇅ mm	◻	lm	cd	✂	K	⌚	ON/OFF	📦	EAN	☑	
2,5	E14	35	97	A+	220			2.500	15.000	50000	10	4000870 283653	✓	283.65



Opal Opale Opaal

W	⊖	∅ mm	⇅ mm	◻	lm	cd	✂	K	⌚	ON/OFF	📦	EAN	☑	
4,5	E14	35	97	A++	450			2.700	15.000	50000	1	4000870 284957	✓	284.95







Satin Satiné Satijn



W	⊖	∅ mm	⇅ mm	□	lm	cd	✂	K	⌚	ON/OFF	📦	EAN	☑	
4,5	E14	35	97	A++	470			2.700	15.000	50000	1	4000870 284964	✓	284.96



Satin Satiné Satijn



W	⊖	∅ mm	⇅ mm	□	lm	cd	✂	K	⌚	ON/OFF	📦	EAN	☑	
4,5	E14	35	120	A++	470			2.700	15.000	50000	1	4000870 284926	✓	284.92



Klar Clair Helder



W	⊖	∅ mm	⇅ mm	□	lm	cd	✂	K	⌚	ON/OFF	📦	EAN	☑	
2,8	E14	35	120	A++	250			2.700	15.000	50000	1	4000870 285077	✓	285.07
4,5	E14	35	120	A++	470			2.700	15.000	50000	1	4000870 285084	✓	285.08



Klar Clair Helder



W	⊖	∅ mm	⇅ mm	□	lm	cd	✂	K	⌚	ON/OFF	📦	EAN	☑	
4,5	E14	35	97	A++	470			2.700	15.000	50000	1	4000870 284940	✓	284.94



Klar Clair Helder



W	⊖	∅ mm	⇅ mm	□	lm	cd	✂	K	⌚	ON/OFF	📦	EAN	☑	
4,5	E14	35	97	A++	470			2.700	15.000	50000	1	4000870 284995	✓	284.99



Gold Doré Goud



W	⊖	∅ mm	⇅ mm	□	lm	cd	✂	K	⌚	ON/OFF	📦	EAN	☑	
4,5	E14	35	97	A++	430			2.500	15.000	50000	1	4000870 284933	✓	284.93



Krokoeis klar Givré clair Craquelé helder



W	⊖	∅ mm	⇅ mm	□	lm	cd	✂	K	⌚	ON/OFF	📦	EAN	☑	
4,5	E14	35	97	A+	400			2.500	15.000	50000	1	4000870 284971	✓	284.97



Gold Doré Goud



W	⊖	∅ mm	⇅ mm	□	lm	cd	✂	K	⌚	ON/OFF	📦	EAN	☑	
4,5	E14	35	97	A++	430			2.500	15.000	50000	1	4000870 284988	✓	284.98



Klar Clair Helder



W	⊖	∅ mm	⇅ mm	◁	lm	cd	✂	K	⌚	ON/OFF	📦	EAN	📄	
4,5	E14	25	82	A++	470			2.700	15.000	50000	1	4000870 285060	✓	285.06



Klar Clair Helder



W	⊖	∅ mm	⇅ mm	◁	lm	cd	✂	K	⌚	ON/OFF	📦	EAN	📄	
2,8	E14	25	82	A++	250			2.700	15.000	50000	1	4000870 285053	✓	285.05



Deco Tube

Opal Opale Opaal

W	⊖	∅ mm	⇅ mm	◁	lm	cd	✂	K	⌚	ON/OFF	📦	EAN	📄	
4,5	E14	30	132	A++	530			2.700	15.000	50000	1	4000870 285138	✓	285.13





Deco Pipe



Satin Satiné Satijn



W	⊖	∅ mm	⇅ mm	◊	lm	cd	↗	K	⌚	ON/OFF	📦	EAN	☑	
4,7	E14	38	142	A <sup>++</sup>	520			2.700	15.000	50000	8	4000870 284353	✓	284.35



Deco Pipe



Satin Satiné Satijn



W	⊖	∅ mm	⇅ mm	◊	lm	cd	↗	K	⌚	ON/OFF	📦	EAN	☑	
4,7	E27	38	142	A <sup>++</sup>	520			2.700	15.000	50000	8	4000870 284360	✓	284.36



Deco Pipe

Opal Opale Opaal

W	⊖	∅ mm	⇅ mm	◊	lm	cd	↗	K	⌚	ON/OFF	📦	EAN	☑	
5,5	E14	38	142	A <sup>+</sup>	470			2.700	15.000	50000	8	4000870 283271	✓	283.27



Deco Pipe

Opal Opale Opaal

W	⊖	∅ mm	⇅ mm	◊	lm	cd	↗	K	⌚	ON/OFF	📦	EAN	☑	
5,5	E27	38	142	A <sup>+</sup>	470			2.700	15.000	50000	8	4000870 283288	✓	283.28



Gold Doré Goud



W	⊖	∅ mm	⇅ mm	◻	lm	cd	✂	K	⌚	ON/OFF	📦	EAN	☑	new
5	E27	125	170	A++	520			2.700	15.000	50000	1	4000870 285480	✓	285.48

5,7 VA



Schwarz matt Noir mat Zwart mat



W	⊖	∅ mm	⇅ mm	◻	lm	cd	✂	K	⌚	ON/OFF	📦	EAN	☑	new
5	E27	125	170	A++	520			2.700	15.000	50000	1	4000870 285497	✓	285.49

5,7 VA



Schwarzchrom Chrome noir Black chrom



W	⊖	∅ mm	⇅ mm	◻	lm	cd	✂	K	⌚	ON/OFF	📦	EAN	☑	new
5	E27	125	170	A++	520			2.700	15.000	50000	1	4000870 285503	✓	285.50

5,7 VA



Opal Opale Opaal



W	⊖	∅ mm	⇅ mm	◻	lm	cd	✂	K	⌚	ON/OFF	📦	EAN	☑	
6	E27	120	173	A++	806			2.700	15.000	50000	1	4000870 284841	✓	284.84

284.84



Klar Clair Helder



W	⊖	∅ mm	⇅ mm	◻	lm	cd	✂	K	⌚	ON/OFF	📦	EAN	☑	
7,5	E27	125	178	A+	806			2.700	15.000	50000	3	4000870 284247	✓	284.24

284.24



Gold Doré Goud

W	⊖	∅ mm	∩ mm	◻	lm	cd	⚡	K	⌚	ON/OFF	📦	EAN	✓	Price
2,5	E27	125	175	A+	170			1.700	15.000	50000	3	4000870 283790	✓	283.79
4	E27	125	175	A+	250			1.700	15.000	50000	3	4000870 283806	✓	283.80
6,5	E27	125	175	A+	420			1.700	15.000	50000	8	4000870 283813	✓	283.81



Gold Doré Goud



W	⊖	∅ mm	⇅ mm	◻	lm	cd	✕	K	⌚	ON/OFF	📦	EAN	☑	
5	E27	95	142	A++	520			2.700	15.000	50000	1	4000870 285459	✓	new 285.45

5,7 VA



Schwarz matt Noir mat Zwart mat



W	⊖	∅ mm	⇅ mm	◻	lm	cd	✕	K	⌚	ON/OFF	📦	EAN	☑	
5	E27	95	142	A++	520			2.700	15.000	50000	1	4000870 285466	✓	new 285.46

5,7 VA



Schwarzchrom Chrome noir Black chrom



W	⊖	∅ mm	⇅ mm	◻	lm	cd	✕	K	⌚	ON/OFF	📦	EAN	☑	
5	E27	95	142	A++	520			2.700	15.000	50000	1	4000870 285473	✓	new 285.47

5,7 VA



Kopfspiegel Silber Calotte argentée Kopspiegel zilver



W	⊖	∅ mm	⇅ mm	◻	lm	cd	✕	K	⌚	ON/OFF	📦	EAN	☑	
6	E27	95	138	A++	750			2.700	15.000	50000	1	4000870 284780	✓	284.78



Kopfspiegel Silber Calotte argentée Kopspiegel zilver

W	⊖	∅ mm	⇅ mm	◻	lm	cd	✕	K	⌚	ON/OFF	📦	EAN	☑	
5	E27	95	138	A+	420			2.700	15.000	50000	4	4000870 283875	✓	283.87



Kopfspiegel Kupfer Calotte réfléchissante en cuivre Kopspiegel koper

W	⊖	∅ mm	⇅ mm	◻	lm	cd	✕	K	⌚	ON/OFF	📦	EAN	☑	
7,5	E27	95	138	A+	680			2.700	15.000	50000	4	4000870 284575	✓	284.57



Opal Opale Opaal



W	⊖	∅ mm	↑ mm	□	lm	cd	✂	K	⌚	ON/OFF	📦	EAN	☑	
6	E27	95	138	A++	806			2.700	15.000	50000	1	4000870 284872	✓	284.87



Klar Clair Helder

W	⊖	∅ mm	↑ mm	□	lm	cd	✂	K	⌚	ON/OFF	📦	EAN	☑	
12	E27	95	138	A++	1.420			2.700	15.000	50000	4	4000870 285442	✓	new 285.44



Gold Doré Goud

W	⊖	∅ mm	↑ mm	□	lm	cd	✂	K	⌚	ON/OFF	📦	EAN	☑	
2,5	E27	95	138	A+	170			1.700	15.000	50000	4	4000870 283882	✓	283.88
6,5	E27	95	138	A+	400			1.700	15.000	50000	4	4000870 283899	✓	283.89
7,5	E27	95	138	A+	550			2.500	15.000	50000	4	4000870 283868	✓	283.86



Krokoeis gold Givré doré Craquelé goud



W	⊖	∅ mm	↑ mm	□	lm	cd	✂	K	⌚	ON/OFF	📦	EAN	☑	
6	E27	95	138	A++	750			2.500	15.000	50000	1	4000870 284889	✓	284.88



Opal Opale Opaal

W	⊖	∅ mm	↑ mm	□	lm	cd	✂	K	⌚	ON/OFF	📦	EAN	☑	
10	E27	95	138	A+	1.055			2.700	15.000	50000	4	4000870 284476	✓	284.47



Opal Opale Opaal



W	⊖	∅ mm	⇅ mm	◁	lm	cd	✂	K	⌚	ON/OFF	📦	EAN	☑	
6	E27	80	120	A++	806			2.700	15.000	50000	1	4000870 284865	✓	284.86



Opal Opale Opaal

W	⊖	∅ mm	⇅ mm	◁	lm	cd	✂	K	⌚	ON/OFF	📦	EAN	☑	
6	E27	80	122	A+	600			2.700	20.000	50000	5	4000870 283370	✓	283.37



Eiskristall klar Granité clair Ijskristal helder



W	⊖	∅ mm	⇅ mm	◁	lm	cd	✂	K	⌚	ON/OFF	📦	EAN	☑	
6	E27	80	120	A++	750			2.700	15.000	50000	1	4000870 284858	✓	284.85



Opal Opale Opaal



W	⊖	∅ mm	⇅ mm	◁	lm	cd	✂	K	⌚	ON/OFF	📦	EAN	☑	
9,5	E27	80	127	A+	806			2.700	25.000	50000	10	4000870 284698	✓	284.69



Satin Satiné Satijn

W	⊖	∅ mm	⇅ mm	◁	lm	cd	✂	K	⌚	ON/OFF	📦	EAN	☑	
2,5	E14	60	97	A+	200			2.700	15.000	50000	6	4000870 282694	✓	282.69





🔗 Klar Clair Helder



W	⊖	∅ mm	⇅ mm	◁	lm	cd	✂	K	🕒	ON/OFF	📦	EAN	☑	
6	E14	45	90	A+	470			2.700	25.000	50000	10	4000870 284674	✓	284.67



🔗 Opal Opale Opaal



W	⊖	∅ mm	⇅ mm	◁	lm	cd	✂	K	🕒	ON/OFF	📦	EAN	☑	
6	E27	45	90	A+	470			2.700	25.000	50000	10	4000870 284681	✓	284.68



🔗 Opal Opale Opaal

W	⊖	∅ mm	⇅ mm	◁	lm	cd	✂	K	🕒	ON/OFF	📦	EAN	☑	
4	E14	45	80	A+	250			2.700	20.000	50000	7	4000870 282939	✓	282.93
3x4	E14	45	80	A+	250			2.700	15.000	50000	1	4000870 284278	✓	new 284.27



🔗 Opal Opale Opaal

W	⊖	∅ mm	⇅ mm	◁	lm	cd	✂	K	🕒	ON/OFF	📦	EAN	☑	
4	E27	45	81	A+	250			2.700	20.000	50000	7	4000870 282946	✓	282.94



🔗 Opal Opale Opaal

W	⊖	∅ mm	⇅ mm	◁	lm	cd	✂	K	🕒	ON/OFF	📦	EAN	☑	
6	E14	45	89	A+	470			2.700	20.000	50000	7	4000870 282953	✓	282.95
3x5,5	E14	45	81	A+	470			2.700	15.000	50000	10	4000870 285374	✓	new 285.37



🔗 Opal Opale Opaal

W	⊖	∅ mm	⇅ mm	◁	lm	cd	✂	K	🕒	ON/OFF	📦	EAN	☑	
6	E27	45	87	A+	470			2.700	20.000	50000	7	4000870 282960	✓	282.96



🔗 Opal Opale Opaal

W	⊖	∅ mm	⇅ mm	◁	lm	cd	✂	K	🕒	ON/OFF	📦	EAN	☑	
3,5	E14	45	79	A+	260			6.500	15.000	50000	8	4000870 283394	✓	283.39





🔗 Klar Clair Helder

W	⚡	∅ mm	⇅ mm	◻	lm	cd	✂	K	🕒	ON/OFF	📦	EAN	📄	
2x2	E14	45	78	A <sup>+</sup>	250			2.700	15.000	50000	10	4000870 284766	✓	284.76



🔗 Klar Clair Helder

W	⚡	∅ mm	⇅ mm	◻	lm	cd	✂	K	🕒	ON/OFF	📦	EAN	📄	
2,5	E14	45	80	A <sup>+</sup>	250			2.700	15.000	50000	8	4000870 283707	✓	283.70



W	⚡	∅ mm	⇅ mm	◻	lm	cd	✂	K	🕒	ON/OFF	📦	EAN	📄	
2,5	E27	45	78	A <sup>+</sup>	250			2.700	15.000	50000	8	4000870 283851	✓	283.85



🔗 Opal Opale Opaal

W	⚡	∅ mm	⇅ mm	◻	lm	cd	✂	K	🕒	ON/OFF	📦	EAN	📄	
2,5	E14	45	78	A <sup>+</sup>	220			2.700	20.000	50000	8	4000870 283349	✓	283.34



W	⚡	∅ mm	⇅ mm	◻	lm	cd	✂	K	🕒	ON/OFF	📦	EAN	📄	
2,5	E27	45	78	A <sup>+</sup>	220			2.700	20.000	50000	8	4000870 283332	✓	283.33



🔗 Gold Doré Goud

W	⚡	∅ mm	⇅ mm	◻	lm	cd	✂	K	🕒	ON/OFF	📦	EAN	📄	
2,5	E14	45	80	A <sup>+</sup>	220			2.500	15.000	50000	8	4000870 283677	✓	283.67



W	⚡	∅ mm	⇅ mm	◻	lm	cd	✂	K	🕒	ON/OFF	📦	EAN	📄	
2,5	E27	45	78	A <sup>+</sup>	200			2.500	15.000	50000	8	4000870 283820	✓	283.82



🔗 Krokoëis gold Givré doré Craquelé goud

W	⚡	∅ mm	⇅ mm	◻	lm	cd	✂	K	🕒	ON/OFF	📦	EAN	📄	
2,5	E14	45	80	A <sup>+</sup>	220			2.500	15.000	50000	8	4000870 283684	✓	283.68



W	⚡	∅ mm	⇅ mm	◻	lm	cd	✂	K	🕒	ON/OFF	📦	EAN	📄	
2,5	E27	45	78	A <sup>+</sup>	200			2.500	15.000	50000	8	4000870 283837	✓	283.83



🔗 Kopfspiegel Silber Calotte argentée Kopspegel zilver

W	⚡	∅ mm	⇅ mm	◻	lm	cd	✂	K	🕒	ON/OFF	📦	EAN	📄	
2,5	E14	45	80	A <sup>+</sup>	220			2.700	15.000	50000	8	4000870 283691	✓	283.69



W	⚡	∅ mm	⇅ mm	◻	lm	cd	✂	K	🕒	ON/OFF	📦	EAN	📄	
2,5	E27	45	78	A <sup>+</sup>	200			2.700	15.000	50000	8	4000870 283844	✓	283.84



🔗 Kopfspiegel Kupfer Calotte réfléchissante en cuivre Kopspegel koper

W	⚡	∅ mm	⇅ mm	◻	lm	cd	✂	K	🕒	ON/OFF	📦	EAN	📄	
2,5	E14	45	80	A <sup>+</sup>	250			2.700	15.000	50000	8	4000870 284551	✓	284.55



**Klar Clair Helder** R, C

W	⊖	∅ mm	⇅ mm	◻	lm	cd	✂	K	⌚	ON/OFF	📦	EAN	☑	
4,5	E14	45	78	A <sup>+</sup>	470			2.700	15.000	50000	1	4000870 285015	✓	<b>285.01</b>



**Klar Clair Helder** R, C

W	⊖	∅ mm	⇅ mm	◻	lm	cd	✂	K	⌚	ON/OFF	📦	EAN	☑	
4,5	E27	45	83	A <sup>+</sup>	470			2.700	15.000	50000	1	4000870 284803	✓	<b>284.80</b>



**Opal Opale Opaal** R, C

W	⊖	∅ mm	⇅ mm	◻	lm	cd	✂	K	⌚	ON/OFF	📦	EAN	☑	
4,5	E14	45	78	A <sup>+</sup>	450			2.700	15.000	50000	1	4000870 285022	✓	<b>285.02</b>



**Opal Opale Opaal** R, C

W	⊖	∅ mm	⇅ mm	◻	lm	cd	✂	K	⌚	ON/OFF	📦	EAN	☑	
4,5	E27	45	83	A <sup>+</sup>	400			2.700	15.000	50000	1	4000870 284810	✓	<b>284.81</b>



**Gold Doré Goud** R, C

W	⊖	∅ mm	⇅ mm	◻	lm	cd	✂	K	⌚	ON/OFF	📦	EAN	☑	
4,5	E14	45	78	A <sup>+</sup>	430			2.500	15.000	50000	1	4000870 285008	✓	<b>285.00</b>



**Gold Doré Goud** R, C

W	⊖	∅ mm	⇅ mm	◻	lm	cd	✂	K	⌚	ON/OFF	📦	EAN	☑	
4,5	E27	45	83	A <sup>+</sup>	400			2.500	15.000	50000	1	4000870 284797	✓	<b>284.79</b>



**Krokoeis klar Givré clair Craquelé helder** R, C

W	⊖	∅ mm	⇅ mm	◻	lm	cd	✂	K	⌚	ON/OFF	📦	EAN	☑	
4,5	E14	45	78	A <sup>+</sup>	400			2.500	15.000	50000	1	4000870 285039	✓	<b>285.03</b>



**Krokoeis gold Givré doré Craquelé goud** R, C

W	⊖	∅ mm	⇅ mm	◻	lm	cd	✂	K	⌚	ON/OFF	📦	EAN	☑	
4,5	E27	45	83	A <sup>+</sup>	400			2.500	15.000	50000	1	4000870 284827	✓	<b>284.82</b>



**Kopfspiegel Silber Calotte argentée Kopspegel zilver** R, C

W	⊖	∅ mm	⇅ mm	◻	lm	cd	✂	K	⌚	ON/OFF	📦	EAN	☑	
4,5	E14	45	78	A <sup>+</sup>	400			2.500	15.000	50000	1	4000870 285046	✓	<b>285.04</b>



**Kopfspiegel Silber Calotte argentée Kopspegel zilver** R, C

W	⊖	∅ mm	⇅ mm	◻	lm	cd	✂	K	⌚	ON/OFF	📦	EAN	☑	
4,5	E27	45	83	A <sup>+</sup>	400			2.700	15.000	50000	1	4000870 284834	✓	<b>284.83</b>



gold LED light  
**1879**  
classic edition



Gold Doré Goud

R, C



W	⚡	∅ mm	↑ mm	◻	lm	cd	✂	K	🕒	ON/OFF	📦	EAN	📄	
6	E27	95	138	A+	500			1.700	15.000	50000	4	4000870 285213	✓	285.21



Gold Doré Goud

R, C



W	⚡	∅ mm	↑ mm	◻	lm	cd	✂	K	🕒	ON/OFF	📦	EAN	📄	
6	E27	64	145	A+	500			1.700	15.000	50000	6	4000870 285237	✓	285.23



Gold Doré Goud

R, C



W	⚡	∅ mm	↑ mm	◻	lm	cd	✂	K	🕒	ON/OFF	📦	EAN	📄	
6	E27	60	104	A+	500			1.700	15.000	50000	6	4000870 285220	✓	285.22



Gold Doré Goud

W	⊖	∅ mm	↑ mm	□	lm	cd	✂	K	⌚	ON/OFF	📦	EAN	📏
2,5	E27	125	175	A+	170			1.700	15.000	50000	1	4000870 284018	284.01
4	E27	125	175	A+	250			1.700	15.000	50000	1	4000870 284025	284.02
6,5	E27	125	175	A+	420			1.700	15.000	50000	1	4000870 284032	284.03



Gold Doré Goud

W	⊖	∅ mm	↑ mm	□	lm	cd	✂	K	⌚	ON/OFF	📦	EAN	📏
2,5	E27	95	138	A+	170			1.700	15.000	50000	1	4000870 283998	283.99
6,5	E27	95	138	A	400			1.700	15.000	50000	1	4000870 284001	284.00



Klar Clair Helder

W	⊖	∅ mm	↑ mm	□	lm	cd	✂	K	⌚	ON/OFF	📦	EAN	📏
2,5	E27	64	154	A+	180			1.800	15.000	50000	1	4000870 284049	284.04
4	E27	64	145	A+	300			1.800	15.000	50000	1	4000870 284056	284.05



Gold Doré Goud

W	⊖	∅ mm	↑ mm	□	lm	cd	✂	K	⌚	ON/OFF	📦	EAN	📏
2,5	E27	64	145	A+	150			1.700	15.000	50000	1	4000870 284063	284.06
4	E27	64	145	A+	250			1.700	15.000	50000	1	4000870 284070	284.07



Gold Doré Goud

W	⊖	∅ mm	↑ mm	□	lm	cd	✂	K	⌚	ON/OFF	📦	EAN	📏
2	E14	35	97	A++	160			1.700	15.000	50000	10	4000870 285244	285.24



Gold Doré Goud

W	⊖	∅ mm	↑ mm	□	lm	cd	✂	K	⌚	ON/OFF	📦	EAN	📏
2	E14	45	78	A++	160			1.700	15.000	50000	8	4000870 285251	285.25



Gold Doré Goud

W	⊖	∅ mm	↑ mm	□	lm	cd	✂	K	⌚	ON/OFF	📦	EAN	📏
2	E14	25	80	A++	160			1.700	15.000	50000	10	4000870 285268	285.26



Klar Clair Helder



W	⊖	∅ mm	⇅ mm	◻	lm	cd	✂	K	⌚	ON/OFF	📦	EAN	☑	
7,5	E27	64	140	A+	806			2.700	15.000	50000	6	4000870 284254	✓	284.25



Klar Clair Helder

W	⊖	∅ mm	⇅ mm	◻	lm	cd	✂	K	⌚	ON/OFF	📦	EAN	☑	
4	E27	64	145	A+	300			1.800	15.000	50000	6	4000870 283929	✓	283.92

Gold Doré Goud



W	⊖	∅ mm	⇅ mm	◻	lm	cd	✂	K	⌚	ON/OFF	📦	EAN	☑	
2,5	E27	64	145	A+	150			1.700	15.000	50000	6	4000870 283943	✓	283.94
4	E27	64	145	A+	250			1.700	15.000	50000	6	4000870 283950	✓	283.95
5	E27	64	145	A+	420			2.500	15.000	50000	6	4000870 283905	✓	283.90
7,5	E27	64	145	A+	550			2.500	15.000	50000	6	4000870 283912	✓	283.91



Klar Clair Helder



W	⊖	∅ mm	⇅ mm	◻	lm	cd	✂	K	⌚	ON/OFF	📦	EAN	☑	
12	R7s	28	118	A+	1.521			2.700	15.000	50000	10	4000870 285428	✓	new 285.42

Klar Clair Helder

W	⊖	∅ mm	⇅ mm	◻	lm	cd	✂	K	⌚	ON/OFF	📦	EAN	☑	
9	R7s	24	118	A+	1.000			2.700	25.000	50000	10	4000870 284582	✓	284.58

Klar Clair Helder

W	⊖	∅ mm	⇅ mm	◻	lm	cd	✂	K	⌚	ON/OFF	📦	EAN	☑	
5	R7s	24	78	A+	500			2.700	25.000	50000	10	4000870 284599	✓	284.59



 Klar Clair Helder

W	⊖	∅ mm	⇅ mm	◻	lm	cd	✂	K	⌚	ON/OFF	📦	EAN	☑	
1	E14	21	60	A+	50			3.000	30.000		10	4000870 281109	✓	281.10
1	E14	21	60	A+	50			6.500	30.000		10	4000870 281116	✓	281.11

 Opal Opale Opaal

W	⊖	∅ mm	⇅ mm	◻	lm	cd	✂	K	⌚	ON/OFF	📦	EAN	☑	
1,8	E14	25	59	A++	140			2.700	15.000	50000	10	4000870 283561	✓	283.56

 Opal Opale Opaal

W	⊖	∅ mm	⇅ mm	◻	lm	cd	✂	K	⌚	ON/OFF	📦	EAN	☑	
3	E14	25	71	A+	250			2.700	15.000	50000	10	4000870 283578	✓	283.57

 Klar Clair Helder

W	⊖	∅ mm	⇅ mm	◻	lm	cd	✂	K	⌚	ON/OFF	📦	EAN	☑	
2	E14	26	65	A++	180			2.700	15.000	50000	10	4000870 284735	✓	284.73

 Klar Clair Helder

W	⊖	∅ mm	⇅ mm	◻	lm	cd	✂	K	⌚	ON/OFF	📦	EAN	☑	
3,5	E14	30	86	A++	340			2.700	15.000	50000	10	4000870 284131	✓	284.13

 Klar Clair Helder

W	⊖	∅ mm	⇅ mm	◻	lm	cd	✂	K	⌚	ON/OFF	📦	EAN	☑	
3,5	E27	30	82	A++	340			2.700	15.000	50000	10	4000870 284117	✓	284.11

 Satin Satiné Satijn

W	⊖	∅ mm	⇅ mm	◻	lm	cd	✂	K	⌚	ON/OFF	📦	EAN	☑	
3,5	E14	30	86	A++	310			2.700	15.000	50000	10	4000870 284148	✓	284.14

 Satin Satiné Satijn

W	⊖	∅ mm	⇅ mm	◻	lm	cd	✂	K	⌚	ON/OFF	📦	EAN	☑	
3,5	E27	30	82	A++	310			2.700	15.000	50000	10	4000870 284124	✓	284.12



Opal Opale Opaal



W	⊖	∅ mm	⇅ mm	◻	lm	cd	✂	K	⌚	ON/OFF	📦	EAN	☑	
4	S14d	30	300	A+	330			2.700	15.000	50000	10	4000870 283035	✓	283.03



Opal Opale Opaal



W	⊖	∅ mm	⇅ mm	◻	lm	cd	✂	K	⌚	ON/OFF	📦	EAN	☑	
4	S14s	30	300	A+	330			2.700	15.000	50000	10	4000870 283028	✓	283.02



Opal Opale Opaal



W	⊖	∅ mm	⇅ mm	◻	lm	cd	✂	K	⌚	ON/OFF	📦	EAN	☑	
6,5	S14d	30	500	A+	500			2.700	15.000	50000	10	4000870 283059	✓	283.05



Opal Opale Opaal



W	⊖	∅ mm	⇅ mm	◻	lm	cd	✂	K	⌚	ON/OFF	📦	EAN	☑	
6,5	S14s	30	500	A+	500			2.700	15.000	50000	10	4000870 283042	✓	283.04
8	S14s	30	300	A+	700			2.700	15.000	50000	10	4000870 285398	✓	new 285.39
12	S14s	30	300	A+	1.100			2.700	15.000	50000	10	4000870 285404	✓	new 285.40

► Nur für Konventionelle Vorschaltgeräte

► Uniquement pour Ballasts traditionnels

► Alleen voor conventionele voorschakelapparaten



Opal Opale Opaal

incl.



W	⊖	∅ mm	⇅ mm	◻	lm	cd	✂	K	⌚	ON/OFF	📦	EAN	☑	
9	G13	27	604	A+	900		170	4.000	25.000	50000	10	4000870 284155	✓	284.15

T8



Opal Opale Opaal

incl.



W	⊖	∅ mm	⇅ mm	◻	lm	cd	✂	K	⌚	ON/OFF	📦	EAN	☑	
18	G13	27	1.214	A+	1.800		170	4.000	25.000	50000	10	4000870 284162	✓	284.16

T8



Opal Opale Opaal

incl.



W	⊖	∅ mm	⇅ mm	◻	lm	cd	✂	K	⌚	ON/OFF	📦	EAN	☑	
22	G13	27	1.515	A+	2.300		170	4.000	25.000	50000	10	4000870 284179	✓	284.17

T8





Color Rendering Index >90



Opal Opale Opaal

CRI >90

W	⊖	∅ mm	⇅ mm	◁	lm /90°	cd	✂	K	⌚	ON/OFF	📦	EAN	☑	
6,5	GU10	51	54	A+	350	820	36	2.700	25.000	50000	7	4000870 284438	✓	284.43



Opal Opale Opaal

CRI >90

W	⊖	∅ mm	⇅ mm	◁	lm	cd	✂	K	⌚	ON/OFF	📦	EAN	☑	
6	E27	60	110	A+	470		240	2.700	15.000	50000	1	4000870 284896	✓	284.89



Opal Opale Opaal

CRI >90

W	⊖	∅ mm	⇅ mm	◁	lm	cd	✂	K	⌚	ON/OFF	📦	EAN	☑	
9,5	E27	60	120	A+	806		240	2.700	15.000	50000	1	4000870 284902	✓	284.90



Opal Opale Opaal

CRI >90

W	⊖	∅ mm	⇅ mm	◁	lm	cd	✂	K	⌚	ON/OFF	📦	EAN	☑	
4	E14	35	110	A+	250			2.700	25.000	50000	8	4000870 284391	✓	284.39
7	E14	38	112	A+	470			2.700	25.000	50000	8	4000870 284407	✓	284.40



Opal Opale Opaal

CRI >90

W	⊖	∅ mm	⇅ mm	◁	lm	cd	✂	K	⌚	ON/OFF	📦	EAN	☑	
4	E14	45	80	A+	250			2.700	25.000	50000	7	4000870 284414	✓	284.41
7	E14	45	89	A+	470			2.700	25.000	50000	7	4000870 284421	✓	284.42



Opal Opale Opaal

W	⊖	∅ mm	⇅ mm	◻	lm	cd	↘	K	⌚	ON/OFF	📦	EAN	📦
2	E27	60	108	A+	150			2.500	15.000	50000	6	4000870 284773	✓ <b>new 284.77</b>



Opal Opale Opaal

W	⊖	∅ mm	⇅ mm	◻	lm	cd	↘	K	⌚	ON/OFF	📦	EAN	📦
2	E27	45	69	A+	90			2.500	15.000	50000	8	4000870 285275	✓ <b>new 285.27</b>

9,5 VA



Rot Rouge Rood

W	⊖	∅ mm	⇅ mm	◻	lm	cd	↘	K	⌚	ON/OFF	📦	EAN	📦
2	E27	45	69	E	1				15.000	50000	8	4000870 285282	✓ <b>new 285.28</b>

9,43 VA



Gelb Jaune Geel

W	⊖	∅ mm	⇅ mm	◻	lm	cd	↘	K	⌚	ON/OFF	📦	EAN	📦
2	E27	45	69	A+	80				15.000	50000	8	4000870 285299	✓ <b>new 285.29</b>

9,43 VA



Blau Bleu Blauw

W	⊖	∅ mm	⇅ mm	◻	lm	cd	↘	K	⌚	ON/OFF	📦	EAN	📦
2	E27	45	69	D	4				15.000	50000	8	4000870 285305	✓ <b>new 285.30</b>

9,43 VA



Grün Vert Groen

W	⊖	∅ mm	⇅ mm	◻	lm	cd	↘	K	⌚	ON/OFF	📦	EAN	📦
2	E27	45	69	B	21				15.000	50000	8	4000870 285312	✓ <b>new 285.31</b>

9,43 VA





Opal Opale Opaal



W	⚡	∅ mm	⇅ mm	◁	lm	cd	✂	K	🕒	ON/OFF	📦	EAN	☑	
9	E27	62	116	A+	650			2.700	25.000	50000	1	4000870 500118	✓	500.11

Boyn



Opal Opale Opaal



W	⚡	∅ mm	⇅ mm	◁	lm		K	🕒	ON/OFF	📦	EAN	☑	
9	E27	62	116	A+	650		2.700 - 6.500	25.000	50000	1	4000870 500125	✓	500.12

Boyn



Opal Opale Opaal



W	⚡	∅ mm	⇅ mm	◁	lm	cd	✂	K	🕒	ON/OFF	📦	EAN	☑	
9	E27	62	116	A	600			2.700	25.000	50000	1	4000870 500132	✓	500.13

Boyn



Klar Clair Helder



W	⚡	∅ mm	⇅ mm	◁	lm/90°	cd	✂	K	🕒	ON/OFF	📦	EAN	☑	
5	GU10	51	58	A+	300	845	35	2.700	25.000	50000	1	4000870 500149	✓	500.14

Teen



Klar Clair Helder



W	⚡	∅ mm	⇅ mm	◁	lm/90°	cd	✂	K	🕒	ON/OFF	📦	EAN	☑	
5	GU10	51	58	A+	300	109	100	2.700 - 6.500	25.000	50000	1	4000870 500156	✓	500.15

Teen



Klar Clair Helder



W	⚡	∅ mm	⇅ mm	◁	lm	cd	✂	K	🕒	ON/OFF	📦	EAN	☑	
5	GU10	51	58	A	210		36	2.700	25.000	50000	1	4000870 501184	✓	new 501.18

Teen



Klar Clair Helder



W	⚡	∅ mm	⇅ mm	◁	lm/120°	cd	✂	K	🕒	ON/OFF	📦	EAN	☑	
3	GU10	51	58	B	25	15	100		25.000	50000	1	4000870 500217	✓	500.21

Teen



## Opal Opale Opaal



W	⚡	∅ mm	⇅ mm	◻	lm	cd	⚡	K	🕒	ON/OFF	📦	EAN	📦
8,5	E27	60	120	A+	650			2.700	25.000	50000	10	4000870 500521	500.52

## Opal Opale Opaal



W	⚡	∅ mm	⇅ mm	◻	lm		K	🕒	ON/OFF	📦	EAN	📦
8,5	E27	60	120	A+	650		2.700 - 6.500	25.000	50000	10	4000870 500538	500.53



Soret

## Opal Opale Opaal



W	⚡	∅ mm	⇅ mm	◻	lm	cd	⚡	K	🕒	ON/OFF	📦	EAN	📦
7,5	E27	60	120	A+	650			2.700	25.000	50000	10	4000870 500545	500.54

## Klar Clair Helder



W	⚡	∅ mm	⇅ mm	◻	lm	cd	⚡	K	🕒	ON/OFF	📦	EAN	📦
4,8	GU10	50	55	A+	350		36	2.700	25.000	50000	20	4000870 500613	500.61



Gatria

## Klar Clair Helder



W	⚡	∅ mm	⇅ mm	◻	lm	cd	⚡	K	🕒	ON/OFF	📦	EAN	📦
3,5	GU10	51	55	A+	230		100	2.700	25.000	50000	10	4000870 500637	new 500.63

7 VA

## Klar Clair Helder



W	⚡	∅ mm	⇅ mm	◻	lm	⚡	K	🕒	ON/OFF	📦	EAN	📦
4,8	GU10	50	55	A+	350	36	2.700 - 6.500	25.000	50000	20	4000870 500620	500.62



Gatria

## Opal Opale Opaal



W	⚡	∅ mm	⇅ mm	◻	lm	cd	⚡	K	🕒	ON/OFF	📦	EAN	📦
4,5	E14	37	115	A+	350			2.700	25.000	50000	15	4000870 500552	500.55

## Opal Opale Opaal



W	⚡	∅ mm	⇅ mm	◻	lm		K	🕒	ON/OFF	📦	EAN	📦
4,5	E14	37	115	A+	350		2.700 - 6.500	25.000	50000	15	4000870 500569	500.56



## Opal Opale Opaal



W	⚡	∅ mm	⇅ mm	◻	lm	cd	⚡	K	🕒	ON/OFF	📦	EAN	📦
2,5	E14	37	115	A+	200		250	2.700	25.000	50000	10	4000870 500576	new 500.57

6 VA

# Energiespar- / Leuchtstofflampen

## Ampoules fluocompactes

### Energiebesparende lampen / neonlampen

**452** Energiesparlampen  
Ampoules à économie d'énergie  
Sparlampen

**455** Leuchtstofflampen  
Tube fluorescent  
Neonbuizen



#### Lumenvergleich

#### Comparaison des lumens

#### Lumenvergelijking

Lichttechnik  
Technologie d'éclairage  
Lichttechniek

(Glüh-) Lampe Watt  
Ampoule (à incandescence) Watt  
(Gloeilamp watt

LED Helligkeit in Lumen  
Luminosité LED en lumens  
LED-helderheid in lumen

Rundumstrahler  
Omnidirectionnels  
Rondomstralers



Glühlampe Klassik  
Ampoule à incandescence classique  
Gloeilamp klassiek



**E14, E27, GU10**

15 W	140 lm
25 W	250 lm
40 W	470 lm
60 W	806 lm
75 W	1055 lm
100 W	1521 lm

Halogen 230V  
**G9, E27, R7s**



25 W	250 lm
40 W	470 lm
60 W	806 lm

Halogen 12V



**G4, GY6,35**

5 W	45 lm
10 W	90 lm
20 W	190 lm
35 W	390 lm
50 W	630 lm

Reflektorlampen  
Lampes à réflecteur  
Reflectorlampen

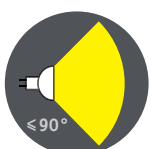

Halogen 230V  
**E14, E27, GU10**



25 W	125 lm
35 W	200 lm
50 W	300 lm

Halogen 12V



**GU4, GU5,3**

10 W	80 lm/90 lm (GU4/GU5,3)
20 W	160 lm/180 lm (GU4/GU5,3)
35 W	300 lm
50 W	540 lm



Opal Opale Opaal

W	⊖	∅ mm	⇅ mm	◻	lm	cd	✂	K	⌚	ON/OFF		EAN	☑	
23	E27	118	175	A	1.400			2.700	8.000	30000	3	4000870 883198	✓	883.19



Opal Opale Opaal

W	⊖	∅ mm	⇅ mm	◻	lm	cd	✂	K	⌚	ON/OFF		EAN	☑	
20	E27	95	128	A	1.248			2.700	8.000	30000	4	4000870 883211	✓	883.21



Opal Opale Opaal

W	⊖	∅ mm	⇅ mm	◻	lm	cd	✂	K	⌚	ON/OFF		EAN	☑	
11	E27	60	111	A	560			2.700	8.000	30000	6	4000870 883136	✓	883.13



Satin Satiné Satijn

W	⊖	∅ mm	⇅ mm	◻	lm	cd	✂	K	⌚	ON/OFF		EAN	☑	
10	E27	100	140	A	565			2.700	8.000	30000	4	4000870 880562	✓	880.56



Opal Opale Opaal

W	⊖	∅ mm	⇅ mm	◻	lm	cd	✂	K	⌚	ON/OFF		EAN	☑	
20	E27	65	140	A	1.250			2.700	8.000	30000	5	4000870 890202	✓	890.20

- ▶ DecoPipe
- ▶ Schlichte Eleganz für sparsame Leuchtmittel
- ▶ DecoPipe
- ▶ Des ampoules économiques à l'élégance sobre
- ▶ DecoPipe
- ▶ Sobere elegantie voor energiebesparende lampen



Deco Pipe

🔗 Satin Satiné Satijn

W	⚡	∅ mm	⇅ mm	◻	lm	cd	✂	K	🕒	ON/OFF [ ]	📦	EAN	📏
9	E14	38	143	A	405			2.700	8.000	30000	8	4000870 894095	✓

894.09



Deco Pipe

🔗 Satin Satiné Satijn

W	⚡	∅ mm	⇅ mm	◻	lm	cd	✂	K	🕒	ON/OFF [ ]	📦	EAN	📏
11	E27	38	140	A	550			2.700	8.000	30000	8	4000870 894118	✓

894.11



Deco Pipe

🔗 Satin Satiné Satijn

W	⚡	∅ mm	⇅ mm	◻	lm	cd	✂	K	🕒	ON/OFF [ ]	📦	EAN	📏
9	E14	38	182	A	460			2.700	8.000	30000	8	4000870 894194	✓

894.19





Opal Opale Opaal

W	⊖	∅ mm	⇅ mm	◻	lm	cd	✂	K	⌚	ON/OFF		EAN	✓	
7	GU10	30	89	A	334			2.700	8.000	30000	8	4000870 860021	✓	860.02



Opal Opale Opaal

W	⊖	∅ mm	⇅ mm	◻	lm	cd	✂	K	⌚	ON/OFF		EAN	✓	
9	GX53	75	26	B	320		100	2.700	10.000	30000	4	4000870 883235	✓	883.23



Opal Opale Opaal

W	⊖	∅ mm	⇅ mm	◻	lm	cd	✂	K	⌚	ON/OFF		EAN	✓	
9	E14	38	130	A	490			2.700	8.000	30000	8	4000870 860076	✓	860.07



Opal Opale Opaal

W	⊖	∅ mm	⇅ mm	◻	lm	cd	✂	K	⌚	ON/OFF		EAN	✓	
9	E14	46	95	A	500			2.700	10.000	30000	8	4000870 894392	✓	894.39



Opal Opale Opaal

W	⊖	∅ mm	⇅ mm	◻	lm	cd	✂	K	⌚	ON/OFF		EAN	✓	
15	E27	48	119	A	950			2.700	10.000	30000	8	4000870 892398	✓	892.39
20	E27	48	130	A	1.200			2.700	10.000	30000	8	4000870 892404	✓	892.40







Opal Opale Opaal

W	⊞	∅ mm	⇅ mm	◻	lm	color	K	⊕	ON/OFF	⊞	EAN	☑	
36	2GX13	26	600	A+	3.350	830	3.000	8.000		6	4000870 884454	✓	884.45

T8



Opal Opale Opaal

W	⊞	∅ mm	⇅ mm	◻	lm	color	K	⊕	ON/OFF	⊞	EAN	☑	
22	2GX13	16	223	A	1.720	827	2.700	12.000		1	4000870 884485	✓	884.48
40	2GX13	16	298	A	3.550	827	2.700	12.000		1	4000870 884478	✓	884.47
55	2GX13	16	298	B	4.125	827	2.700	12.000		1	4000870 884461	✓	884.46

T5



Opal Opale Opaal

W	⊞	∅ mm	⇅ mm	◻	lm	color	K	⊕	ON/OFF	⊞	EAN	☑	
40	G10q	30	403	A	2.800	827	2.700	8.000		1	4000870 884409	✓	884.40

T9



Opal Opale Opaal

W	⊞	∅ mm	⇅ mm	◻	lm	color	K	⊕	ON/OFF	⊞	EAN	☑	
24	E27	227	80	A	1.445	827	2.700	8.000	10000	1	4000870 860038	✓	860.03





Opal Opale Opaal

T5

W	⊖	∅ mm	↑ mm	⊏	lm	color	K	⌚	ON/OFF	⊞	EAN	☑	
8	G5	16	301	A	480	830	3.000	5.000		10	4000870 885086	☑	885.08

13	G5	16	530	A	950	830	3.000	5.000		10	4000870 885130	☑	885.13
----	----	----	-----	---	-----	-----	-------	-------	--	----	----------------	---	--------

T5

W	⊖	∅ mm	↑ mm	⊏	lm	color	K	⌚	ON/OFF	⊞	EAN	☑	
8	G5	16	301	A	440	840	4.000	5.000		10	4000870 885604	☑	885.60

13	G5	16	530	A	950	840	4.000	5.000		10	4000870 885611	☑	885.61
----	----	----	-----	---	-----	-----	-------	-------	--	----	----------------	---	--------

14	G5	16	560	A+	1.205	840	4.000	10.000		10	4000870 885635	☑	885.63
----	----	----	-----	----	-------	-----	-------	--------	--	----	----------------	---	--------

21	G5	16	864	A+	1.890	840	4.000	10.000		10	4000870 885628	☑	885.62
----	----	----	-----	----	-------	-----	-------	--------	--	----	----------------	---	--------

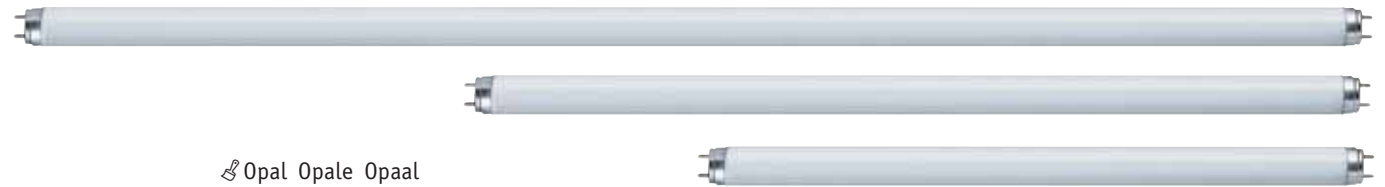

Opal Opale Opaal

T8

W	⊖	∅ mm	↑ mm	⊏	lm	color	K	⌚	ON/OFF	⊞	EAN	☑	
15	G13	26	451	B	963	827	2.700	8.000		10	4000870 885154	☑	885.15

18	G13	26	604	A	1.350	827	2.700	8.000		10	4000870 885215	☑	885.21
----	-----	----	-----	---	-------	-----	-------	-------	--	----	----------------	---	--------

30	G13	26	910	A	2.400	827	2.700	8.000		10	4000870 885451	☑	885.45
----	-----	----	-----	---	-------	-----	-------	-------	--	----	----------------	---	--------

36	G13	26	1.214	A+	3.348	827	2.700	8.000		10	4000870 885499	☑	885.49
----	-----	----	-------	----	-------	-----	-------	-------	--	----	----------------	---	--------

58	G13	26	1.515	A	5.220	827	2.700	8.000		10	4000870 885536	☑	885.53
----	-----	----	-------	---	-------	-----	-------	-------	--	----	----------------	---	--------

T8

W	⊖	∅ mm	↑ mm	⊏	lm	color	K	⌚	ON/OFF	⊞	EAN	☑	
18	G13	26	604	A	1.350	840	4.000	8.000		10	4000870 885413	☑	885.41

30	G13	26	910	A	2.400	840	4.000	8.000		10	4000870 885208	☑	885.20
----	-----	----	-----	---	-------	-----	-------	-------	--	----	----------------	---	--------

36	G13	26	1.214	A+	3.348	840	4.000	8.000		10	4000870 885505	☑	885.50
----	-----	----	-------	----	-------	-----	-------	-------	--	----	----------------	---	--------

58	G13	26	1.515	A	5.167	840	4.000	8.000		10	4000870 885543	☑	885.54
----	-----	----	-------	---	-------	-----	-------	-------	--	----	----------------	---	--------

T8

W	⊖	∅ mm	↑ mm	⊏	lm	color	K	⌚	ON/OFF	⊞	EAN	☑	
18	G13	26	604	A	1.215	865	6.500	8.000		10	4000870 885192	☑	885.19

30	G13	26	910	A	2.160	865	6.500	8.000		10	4000870 885444	☑	885.44
----	-----	----	-----	---	-------	-----	-------	-------	--	----	----------------	---	--------

36	G13	26	1.214	A	3.013	865	6.500	8.000		10	4000870 885369	☑	885.36
----	-----	----	-------	---	-------	-----	-------	-------	--	----	----------------	---	--------

58	G13	26	1.515	A	4.698	865	6.500	8.000		10	4000870 885581	☑	885.58
----	-----	----	-------	---	-------	-----	-------	-------	--	----	----------------	---	--------



**Starter Tandem/Duo**

max. 2x4-22 W  
 ↑39 ∅20 mm  
 EAN 4000870 884249  
**884.24**

- ☞ Weiß ☐ Kunststoff
- ☞ Blanc ☐ Matière plastique
- ☞ Wit ☐ Kunststof



**Starter Universal**

max. 4-65 W  
 ↑39 ∅20 mm  
 EAN 4000870 884843  
**884.84**

- ☞ Weiß ☐ Kunststoff
- ☞ Blanc ☐ Matière plastique
- ☞ Wit ☐ Kunststof

# Halogenlampen 12V

## Ampoules halogènes 12V

### Halogeenlampen 12V

- 458** Stiftsockel  
Bi-pin  
Pencontactdoos
- 458** Reflektorlampen GU4  
Réflecteurs GU4  
Reflectorlampen GU4
- 459** Reflektorlampen GU5,3  
Réflecteurs GU5,3  
Reflectorlampen GU5,3



#### Lumenvergleich

#### Comparaison des lumens

#### Lumenvergelijking

Lichttechnik  
Technologie d'éclairage  
Lichttechniek

(Glüh-) Lampe Watt  
Ampoule (à incandescence) Watt  
(Gloeilamp watt

LED Helligkeit in Lumen  
Luminosité LED en lumens  
LED-helderheid in lumen

Rundumstrahler  
Omnidirectionnels  
Rondomstralers

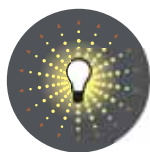

Glühlampe Klassik Ampoule à incandescence classique Gloeilamp klassiek		15 W	140 lm
		25 W	250 lm
		40 W	470 lm
		60 W	806 lm
		75 W	1055 lm
		100 W	1521 lm
<b>E14, E27, GU10</b>			
Halogen 230V <b>G9, E27, R7s</b>		25 W	250 lm
		40 W	470 lm
		60 W	806 lm
Halogen 12V <b>G4, GY6,35</b>		5 W	45 lm
		10 W	90 lm
		20 W	190 lm
		35 W	390 lm
		50 W	630 lm

Reflektorlampen  
Lampes à réflecteur  
Reflectorlampen

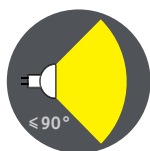

Halogen 230V <b>E14, E27, GU10</b>		25 W	125 lm
		35 W	200 lm
		50 W	300 lm
Halogen 12V <b>GU4, GU5,3</b>		10 W	80 lm/90 lm (GU4/GU5,3)
		20 W	160 lm/180 lm (GU4/GU5,3)
		35 W	300 lm
		50 W	540 lm

🔗 Klar Clair Helder



W	⊖	∅ mm	⇅ mm	◻	lm	cd	⚡	K	🕒	ON/OFF	📦	EAN	☑	
2x10	G4	9	33	C	130			2.900	2.000	8000	10	4000870 831151	☑	831.15
2x20	G4	9	33	C	290			2.900	2.000	8000	10	4000870 831175	☑	831.17
2x35	G4	9	33	C	533			2.900	2.000	8000	10	4000870 800348	☑	800.34

🔗 Klar Clair Helder



W	⊖	∅ mm	⇅ mm	◻	lm	cd	⚡	K	🕒	ON/OFF	📦	EAN	☑	
2x20	GY6,35	10	38	C	255			2.900	2.000	8000	10	4000870 831168	☑	831.16
2x35	GY6,35	10	38	C	600			2.900	2.000	8000	10	4000870 831182	☑	831.18
2x50	GY6,35	10	38	C	850			2.900	2.000	8000	10	4000870 831199	☑	831.19



Cool beam

🔗 Silber Argent Zilver



W	⊖	∅ mm	⇅ mm	◻	lm <sub>/90°</sub>	cd	⚡	K	🕒	ON/OFF	📦	EAN	☑	
2x10	GU4	35	35	B	74	280	30	2.900	2.000	8000	10	4000870 838242	☑	838.24

▶ Security

▶ Leitet 80 % der Wärme nach vorn ab (Spezialbeschichtung). Ideal für Einbauleuchten (Dämmmaterial nicht gefährdet)

▶ Security

▶ Diffuse 80% de la chaleur vers l'avant (revêtement spécial). Idéal pour les encastrés (matériaux isolants protégés)

▶ Security

▶ Leidt 80% van de warmte naar voren weg (speciale coating). Optimaal voor inbouwlampen (isolatiemateriaal niet in gevaar)



🔗 Silber Argent Zilver

W	⊖	∅ mm	⇅ mm	◻	lm <sub>/90°</sub>	cd	⚡	K	🕒	ON/OFF	📦	EAN	☑	
2x20	GU4	35	35	B	220	470	30	2.900	2.000	8000	10	4000870 832479	☑	832.47



Security

W	⊖	∅ mm	⇅ mm	◻	lm <sub>/90°</sub>	cd	⚡	K	🕒	ON/OFF	📦	EAN	☑	
3x20	GU4	35	35	B	201	450	24	3.000	4.000	16000	1	4000870 833827	☑	833.82

3x35	GU4	35	35	B	430	800	24	3.000	4.000	16000	1	4000870 833834	☑	833.83
------	-----	----	----	---	-----	-----	----	-------	-------	-------	---	----------------	---	--------

▶ Maxiflood

▶ Strahlt gleichmäßig rundum in alle Richtungen (ideal für farbige Lampenschirme)

▶ Maxiflood

▶ Rayonne uniformément dans toutes les directions (idéal pour les abat-jour de couleur)

▶ Maxiflood

▶ Straalt gelijkmatig rondom in alle richtingen (optimaal voor gekleurde lampenschermen)



🔗 Softopal Soft-opale Softopaal



Maxiflood

W	⊖	∅ mm	⇅ mm	◻	lm	cd	⚡	K	🕒	ON/OFF	📦	EAN	☑	
2x20	GU4	35	35	C	280			2.900	2.000	8000	10	4000870 832332	☑	832.33

2x35	GU4	35	35	C	533			2.900	2.000	8000	10	4000870 833766	☑	833.76
------	-----	----	----	---	-----	--	--	-------	-------	------	----	----------------	---	--------

- ▶ Juwel
- ▶ Nach vorn strahlt brillantes Halogenlicht, nach hinten satinfarben schimmernde Reflexionen.

- ▶ Juwel
- ▶ Émet une lumière halogène brillante vers l'avant et des reflets lumineux vers l'arrière.

- ▶ Juwel
- ▶ Naar voren straalt briljant halogeenlicht, naar achteren satijnkleurige, fonkelende reflecties.



Juwel

🎵 Satin Satiné Satijn



W	⚡	∅ mm	⇅ mm	◻	lm <sub>90°</sub>	cd	⚡	K	🕒	ON/OFF	📦	EAN	☑	
2x20	GU4	35	35	B	220	730	30	2.900	2.000	8000	10	4000870 838266	☑	838.26



Cool beam

🎵 Silber Argent Zilver



W	⚡	∅ mm	⇅ mm	◻	lm <sub>90°</sub>	cd	⚡	K	🕒	ON/OFF	📦	EAN	☑	
20	GU5,3	51	45	B	203	700	38	2.900	4.000	16000	10	4000870 833797	☑	833.79

- ▶ Security
- ▶ Leitet 80 % der Wärme nach vorn ab (Spezialbeschichtung). Ideal für Einbauleuchten (Dämmmaterial nicht gefährdet)

- ▶ Security
- ▶ Diffuse 80% de la chaleur vers l'avant (revêtement spécial). Idéal pour les encastrés (matériaux isolants protégés)

- ▶ Security
- ▶ Leidt 80% van de warmte naar voren weg (speciale coating). Optimaal voor inbouwlampen (isolatiemateriaal niet in gevaar)



🎵 Silber Argent Zilver

W	⚡	∅ mm	⇅ mm	◻	lm <sub>90°</sub>	cd	⚡	K	🕒	ON/OFF	📦	EAN	☑	
20	GU5,3	51	45	B	201	700	38	2.900	4.000	16000	10	4000870 832448	☑	832.44

35	GU5,3	51	45	B	430	1.100	38	2.900	4.000	16000	10	4000870 832455	☑	832.45
----	-------	----	----	---	-----	-------	----	-------	-------	-------	----	----------------	---	--------

50	GU5,3	51	45	B	675	1.800	38	2.900	4.000	16000	10	4000870 832462	☑	832.46
----	-------	----	----	---	-----	-------	----	-------	-------	-------	----	----------------	---	--------



Security

W	⚡	∅ mm	⇅ mm	◻	lm <sub>90°</sub>	cd	⚡	K	🕒	ON/OFF	📦	EAN	☑	
3x20	GU5,3	51	46	B	201	450	38	3.000	4.000	16000	1	4000870 833841	☑	833.84

3x35	GU5,3	51	46	B	430	800	38	3.000	4.000	16000	1	4000870 833858	☑	833.85
------	-------	----	----	---	-----	-----	----	-------	-------	-------	---	----------------	---	--------

3x50	GU5,3	51	46	B	680	1.300	38	3.000	4.000	16000	1	4000870 833865	☑	833.86
------	-------	----	----	---	-----	-------	----	-------	-------	-------	---	----------------	---	--------

- ▶ Maxiflood
- ▶ Strahlt gleichmäßig rundum in alle Richtungen (ideal für farbige Lampenschirme)

- ▶ Maxiflood
- ▶ Rayonne uniformément dans toutes les directions (idéal pour les abat-jour de couleur)

- ▶ Maxiflood
- ▶ Straalt gelijkmatig rondom in alle richtingen (optimaal voor gekleurde lampenschermen)



Maxiflood

🎵 Softopal Soft-opale Softopaal

W	⚡	∅ mm	⇅ mm	◻	lm	cd	⚡	K	🕒	ON/OFF	📦	EAN	☑	
20	GU5,3	51	45	C	255			2.900	2.000	8000	10	4000870 832530	☑	832.53

35	GU5,3	51	45	C	533			2.900	2.000	8000	10	4000870 832608	☑	832.60
----	-------	----	----	---	-----	--	--	-------	-------	------	----	----------------	---	--------



- ▶ Juwel
- ▶ Nach vorn strahlt brillantes Halogenlicht, nach hinten satinfarben schimmernde Reflexionen.

- ▶ Juwel
- ▶ Émet une lumière halogène brillante vers l'avant et des reflets lumineux vers l'arrière.

- ▶ Juwel
- ▶ Naar voren straalt briljant halogeenlicht, naar achteren satijnkleurige, fonkelende reflecties.



Juwel

☞ Silber Argent Zilver



W	⊖	∅ mm	⇅ mm	◻	lm <sub>90°</sub>	cd	✂	K	⌚	ON/OFF	📦	EAN	☑	
20	GU5,3	51	45	B	200	700	38	2.900	4.000	16000	10	4000870 833148	✓	833.14

- ▶ Akzent
- ▶ Langlebige Außenbeschichtung in alu, silber, schwarz oder gold

- ▶ Akzent
- ▶ Revêtement extérieur durable en aluminium, argent, noir ou or

- ▶ Akzent
- ▶ Buitencoating met lange levensduur in alu, zilver, zwart of goud



Akzent

☞ Alu Alu Alu

W	⊖	∅ mm	⇅ mm	◻	lm <sub>90°</sub>	cd	✂	K	⌚	ON/OFF	📦	EAN	☑	
35	GU5,3	51	45	B	435	1.100	38	2.900	4.000	16000	10	4000870 832097	✓	832.09



Quadro

☞ Silber Argent Zilver



W	⊖	∅ mm	⇅ mm	◻	lm <sub>90°</sub>	cd	✂	K	⌚	ON/OFF	📦	EAN	☑	
20	GU5,3	37	45	B	201	220	75	2.900	2.000	8000	10	4000870 833711	✓	833.71
35	GU5,3	37	45	B	427	460	75	2.900	2.000	8000	10	4000870 833742	✓	833.74



AR 111

☞ Silber Argent Zilver

W	⊖	∅ mm	⇅ mm	◻	lm <sub>90°</sub>	cd	✂	K	⌚	ON/OFF	📦	EAN	☑	
50	G53	111	58	B	510	2.900	24	2.900	4.000	16000	10	4000870 832660	✓	832.66

# Halogenlampen 230V

## Ampoules halogènes 230V

### Halogeenlampen 230V



#### Lumenvergleich

#### Comparaison des lumens

#### Lumenvergelijking

Lichttechnik  
Technologie d'éclairage  
Lichttechniek

(Glüh-) Lampe Watt  
Ampoule (à incandescence) Watt  
(Gloeilamp watt

LED Helligkeit in Lumen  
Luminosité LED en lumens  
LED-helderheid in lumen

Rundumstrahler  
Omnidirectionnels  
Rondomstralers



Glühlampe Klassik  
Ampoule à incandescence classique  
Gloeilamp klassiek



**E14, E27, GU10**

15 W	140 lm
25 W	250 lm
40 W	470 lm
60 W	806 lm
75 W	1055 lm
100 W	1521 lm

Halogen 230V  
**G9, E27, R7s**



25 W	250 lm
40 W	470 lm
60 W	806 lm

Halogen 12V



**G4, GY6,35**

5 W	45 lm
10 W	90 lm
20 W	190 lm
35 W	390 lm
50 W	630 lm

Reflektorlampen  
Lampes à réflecteur  
Reflectorlampen

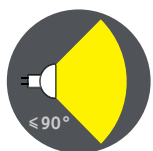

Halogen 230V  
**E14, E27, GU10**



25 W	125 lm
35 W	200 lm
50 W	300 lm

Halogen 12V



**GU4, GU5,3**

10 W	80 lm/90 lm (GU4/GU5,3)
20 W	160 lm/180 lm (GU4/GU5,3)
35 W	300 lm
50 W	540 lm

**Kombinieren Sie selbst!**  
**Composez vous-même votre luminaire !**  
**Combineer zelf!**

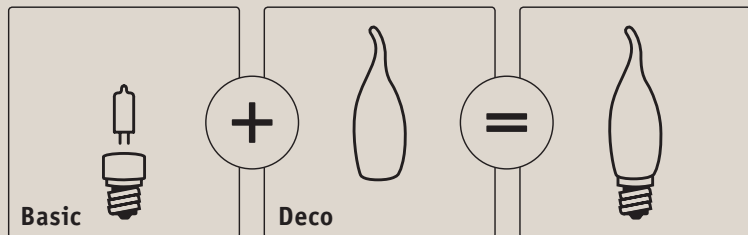

Dekorierte Halogenlampen von Paulmann – alle Formen, viele Farben

- ▶ Beliebte dekorierte Formen und Farben für diverse Leuchtenstile
- ▶ Opale matte Oberflächen
- ▶ Für Sockel mit E14, E27, B22d oder B15d-Fassung
- ▶ Brillantes Licht, effiziente Technik: Bis zu 25 % weniger Energieverbrauch <sup>1)</sup>
- ▶ Kombinieren Sie selbst - Glas + Sockel = dekorierte Lampe

Ampoules halogènes décoratives Paulmann – toutes les formes, de nombreux coloris

- ▶ Des formes décoratives et des couleurs appréciées pour différents styles de luminaires
- ▶ Surfaces opales dépolies
- ▶ Pour culot douille E14, E27, B22d ou B15d
- ▶ Lumière brillante, technologie éprouvée : Jusqu'à 25 % de consommation d'énergie en moins <sup>1)</sup>
- ▶ Composez vous-même : verre + culot = ampoule décorative

Gedecoreerde halogeenlampen van Paulmann – alle vormen, vele kleuren

- ▶ Populaire gedecoreerde vormen en kleuren voor diverse lampstijlen
- ▶ Opaal matte oppervlaktes
- ▶ Voor sokkels met E14, E27, B22d of B15d-fitting
- ▶ Brillant licht, efficiënte techniek: Tot 25 % minder energieverbruik <sup>1)</sup>
- ▶ Combineer zelf - Glas + Fitting = Gedecoreerde lamp



<sup>1)</sup> Gegenüber herkömmlicher Glühlampe par rapport à une ampoule à incandescence traditionnelle In verhouding tot gebruikelijke gloeilampen

**Klar Clair Helder**



W	⚡	∅ mm	∩ mm	◻	lm	cd	⚡	K	⌚	ON/OFF	📦	EAN	☑	€
20	E27	28	51	D	235			2.700	2.000	8000	10	4000870 549162	✓	549.16
33	E27	28	51	D	460			2.800	2.000	8000	10	4000870 549179	✓	549.17
42	E27	28	51	D	630			2.800	2.000	8000	10	4000870 549186	✓	549.18
70	E27	28	51	D	1.173			2.900	2.000	8000	10	4000870 549261	✓	549.26

W	⚡	∅ mm	∩ mm	◻	lm	cd	⚡	K	⌚	ON/OFF	📦	EAN	☑	€
20	E14	25	52	D	235			2.700	2.000	8000	10	4000870 549193	✓	549.19
33	E14	25	52	D	460			2.800	2.000	8000	10	4000870 549209	✓	549.20
42	E14	25	52	D	630			2.800	2.000	8000	10	4000870 549216	✓	549.21

**Weiß Blanc Wit**



W	⚡	∅ mm	∩ mm	◻	lm	cd	⚡	K	⌚	ON/OFF	📦	EAN	☑	€
	G9 / B22d	28	50								10	4000870 549278	✓	549.27
	G9 / B15d	25	50								10	4000870 549285	✓	549.28





Opal Opale Opaal



∅ mm	↑ mm		EAN		
100	107	4	4000870 875698	✓	<b>875.69</b>



∅ mm	↑ mm		EAN		
80	88	5	4000870 875773	✓	<b>875.77</b>



∅ mm	↑ mm		EAN		
60	70	6	4000870 875759	✓	<b>875.75</b>



∅ mm	↑ mm		EAN		
45	52	8	4000870 875742	✓	<b>875.74</b>



∅ mm	↑ mm		EAN		
38	88	10	4000870 875766	✓	<b>875.76</b>

Satin Satiné Satijn



∅ mm	↑ mm		EAN		
60	70	6	4000870 870013	✓	<b>870.01</b>



∅ mm	↑ mm		EAN		
45	52	8	4000870 870037	✓	<b>870.03</b>



∅ mm	↑ mm		EAN		
38	88	8	4000870 875728	✓	<b>875.72</b>



∅ mm	↑ mm		EAN		
35	105	10	4000870 870075	✓	<b>870.07</b>

Eiskristall klar Granité clair  
IJs kristal helder



∅ mm	↑ mm		EAN		
45	52	8	4000870 875636	✓	<b>875.63</b>

Eiskristall Bernstein Granité ambre  
IJs kristal barnsteen



∅ mm	↑ mm		EAN		
60	70	6	4000870 875605	✓	<b>875.60</b>

Krokoes gold Givré doré  
Craquelé goud



∅ mm	↑ mm		EAN		
80	88	5	4000870 875858	✓	<b>875.85</b>



∅ mm	↑ mm		EAN		
60	70	6	4000870 875882	✓	<b>875.88</b>





☞ Klar Clair Helder

W	⊖	∅ mm	⇅ mm	◻	lm	cd	⚡	K	⌚	ON/OFF	📦	EAN	☑	
60	R7s	12	78	D	971			2.900	2.000	8000	10	4000870 800607	☑	800.60
120	R7s	12	117	D	2.216			2.900	2.000	8000	10	4000870 800591	☑	800.59
160	R7s	12	117	C	3.085			2.900	2.000	8000	10	4000870 800409	☑	800.40
230	R7s	12	117	C	4.644			3.000	2.000	8000	10	4000870 800416	☑	800.41
400	R7s	12	117	C	8.545			3.000	2.000	8000	10	4000870 800423	☑	800.42

☞ Klar Clair Helder

W	⊖	∅ mm	⇅ mm	◻	lm	cd	⚡	K	⌚	ON/OFF	📦	EAN	☑	
2x20	G9	13	42	D	240			2.700	2.000	8000	10	4000870 800300	☑	800.30
2x28	G9	13	42	D	370			2.700	2.000	8000	10	4000870 800621	☑	800.62
2x33	G9	13	42	D	460			2.800	2.000	8000	10	4000870 800317	☑	800.31
2x42	G9	13	42	D	625			2.800	2.000	8000	10	4000870 800324	☑	800.32
2x52	G9	13	42	D	815			2.800	2.000	8000	10	4000870 800331	☑	800.33
2x70	G9	13	42	D	1.173			2.900	2.000	8000	10	4000870 800638	☑	800.63



Deco Pipe

☞ Klar Clair Helder

W	⊖	∅ mm	⇅ mm	◻	lm	cd	⚡	K	⌚	ON/OFF	📦	EAN	☑	
28	GZ10	22	80	C	340			2.700	1.000	4000	10	4000870 800652	☑	800.65

- ▶ Maxiflood
- ▶ Strahlt gleichmäßig rundum in alle Richtungen (ideal für farbige Lampenschirme)
- ▶ Maxiflood
- ▶ Rayonne uniformément dans toutes les directions (idéal pour les abat-jour de couleur)
- ▶ Maxiflood
- ▶ Straalt gelijkmatig rondom in alle richtingen (optimaal voor gekleurde lampenschermen)

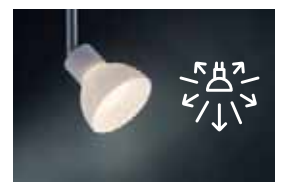

Maxiflood

☞ Softopal Soft-opale Softopaal

W	⊖	∅ mm	⇅ mm	◻	lm	cd	⚡	K	⌚	ON/OFF	📦	EAN	☑	
28	GZ10	51	55	D	370			2.700	2.000	8000	10	4000870 800430	☑	800.43
40	GZ10	51	55	D	586			2.800	2.000	8000	10	4000870 800447	☑	800.44

☞ Weiß Blanc Wit

W	⊖	∅ mm	⇅ mm	◻	lm	cd	⚡	K	⌚	ON/OFF	📦	EAN	☑	
max. 50	GU10 / E27	35	53								10	4000870 549292	☑	549.29



## Klar Clair Helder



W	⊖	∅ mm	↑ mm	□	lm	cd	↗	K	⌚	ON/OFF	⊞	EAN	⊞
18	E27	55	98	D	205			2.700	2.000	8000	6	4000870 400258	400.25
28	E27	55	98	D	370			2.700	2.000	8000	6	4000870 400265	400.26
42	E27	55	98	D	625			2.800	2.000	8000	6	4000870 400272	400.27
52	E27	60	106	D	815			2.800	2.000	8000	6	4000870 400289	400.28
70	E27	60	106	D	1.180			2.900	2.000	8000	6	4000870 400296	400.29



## Klar Clair Helder

W	⊖	∅ mm	↑ mm	□	lm	cd	↗	K	⌚	ON/OFF	⊞	EAN	⊞
105	E27	60	105	C	1.900			2.900	2.000	8000	6	4000870 400173	400.17
120	E27	60	105	C	2.216			2.900	2.000	8000	6	4000870 400180	400.18



## Klar Clair Helder

W	⊖	∅ mm	↑ mm	□	lm	cd	↗	K	⌚	ON/OFF	⊞	EAN	⊞
42	B22d	55	97	D	625			2.800	2.000	8000	6	4000870 400302	400.30



## Klar Clair Helder

W	⊖	∅ mm	↑ mm	□	lm	cd	↗	K	⌚	ON/OFF	⊞	EAN	⊞
18	E14	35	98	D	205			2.700	2.000	8000	10	4000870 510421	510.42
28	E14	35	98	D	370			2.700	2.000	8000	10	4000870 510438	510.43
42	E14	35	98	D	625			2.800	2.000	8000	10	4000870 510445	510.44



## Klar Clair Helder

W	⊖	∅ mm	↑ mm	□	lm	cd	↗	K	⌚	ON/OFF	⊞	EAN	⊞
18	E14	35	124	D	205			2.700	2.000	8000	10	4000870 510469	510.46
28	E14	35	124	D	370			2.700	2.000	8000	10	4000870 513286	513.28
42	E14	35	124	D	625			2.800	2.000	8000	10	4000870 513293	513.29





🔗 Klar Clair Helder

W	⚡	∅ mm	↑ mm	◻	lm	cd	↘	K	⌚	ON/OFF	📦	EAN	📦
20	E14	25	85	D	235			2.700	2.000	8000	10	4000870 540237	540.23
33	E14	25	85	D	458			2.800	2.000	8000	10	4000870 540244	540.24

🔗 Klar Clair Helder



W	⚡	∅ mm	↑ mm	◻	lm	cd	↘	K	⌚	ON/OFF	📦	EAN	📦
18	E27	45	72	D	205			2.700	2.000	8000	8	4000870 800164	800.16
28	E27	45	74	D	370			2.700	2.000	8000	8	4000870 800171	800.17
42	E27	45	74	D	625			2.800	2.000	8000	8	4000870 800188	800.18

🔗 Klar Clair Helder



W	⚡	∅ mm	↑ mm	◻	lm	cd	↘	K	⌚	ON/OFF	📦	EAN	📦
18	E14	45	80	D	205			2.700	2.000	8000	8	4000870 314654	314.65
28	E14	45	80	D	370			2.700	2.000	8000	8	4000870 314661	314.66
42	E14	45	80	D	625			2.800	2.000	8000	8	4000870 314678	314.67



# Konventionelle Leuchtmittel

## Ampoules incandescentes

### Conventionele lampen

- 468** Birnenlampe  
Poirettes  
Schakelbordlampen
- 469** Tropfenlampen  
Spheriques  
Kogellampen
- 470** Kerzenlampen  
Flammes  
Kaarslampen
- 471** Allgebrauchslampen  
Standard  
Standaard gebruikslampen
- 472** Reflektorlampen  
Réflecteurs  
Reflectorlampen
- 473** Speziallampen  
Lampes spéciales  
Speciaallampen



#### Lumenvergleich

#### Comparaison des lumens

#### Lumenvergelijking

Lichttechnik  
Technologie d'éclairage  
Lichttechniek

(Glüh-) Lampe Watt  
Ampoule (à incandescence) Watt  
(Gloeilamp) watt

LED Helligkeit in Lumen  
Luminosité LED en lumens  
LED-helderheid in lumen

Rundumstrahler  
Omnidirectionnels  
Rondomstralers



Glühlampe Klassik  
Ampoule à incandescence classique  
Gloeilamp klassiek



**E14, E27, GU10**

15 W	140 lm
25 W	250 lm
40 W	470 lm
60 W	806 lm
75 W	1055 lm
100 W	1521 lm

Halogen 230V  
**G9, E27, R7s**



25 W	250 lm
40 W	470 lm
60 W	806 lm

Halogen 12V



**G4, GY6,35**

5 W	45 lm
10 W	90 lm
20 W	190 lm
35 W	390 lm
50 W	630 lm

Reflektorlampen  
Lampes à réflecteur  
Reflectorlampen

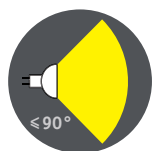

Halogen 230V  
**E14, E27, GU10**



25 W	125 lm
35 W	200 lm
50 W	300 lm

Halogen 12V



**GU4, GU5,3**

10 W	80 lm/90 lm (GU4/GU5,3)
20 W	160 lm/180 lm (GU4/GU5,3)
35 W	300 lm
50 W	540 lm



🎵 Klar Clair Helder

W	⚡	∅ mm	⇅ mm	◻	lm	cd	✂	K	🕒	ON/OFF		EAN	📦
7	E14	25	60	D	43			2.300	1.000		16	4000870 800157	

**800.15**



🎵 Rot Rouge Rood



W	⚡	∅ mm	⇅ mm	◻	lm	cd	✂	K	🕒	ON/OFF		EAN	📦
15	E14	25	60	E	26				1.000		16	4000870 800119	

**800.11**



🎵 Gelb Jaune Geel



W	⚡	∅ mm	⇅ mm	◻	lm	cd	✂	K	🕒	ON/OFF		EAN	📦
15	E14	25	60	E	83				1.000		16	4000870 800126	

**800.12**



🎵 Grün Vert Groen



W	⚡	∅ mm	⇅ mm	◻	lm	cd	✂	K	🕒	ON/OFF		EAN	📦
15	E14	25	60	E	29				1.000		16	4000870 800133	

**800.13**



🎵 TV - Blau TV - Bleu TV - blauw



W	⚡	∅ mm	⇅ mm	◻	lm	cd	✂	K	🕒	ON/OFF		EAN	📦
15	E14	25	60	E	20				1.000		16	4000870 810101	

**810.10**





Imatt Dépoli Mat

W	⊖	∅ mm	⇅ mm	□	lm	cd	✂	K	⌚	ON/OFF	📦	EAN	📦
8	E27	45	70	E	40			2.300	1.000		8	4000870 128084	128.08



W	⊖	∅ mm	⇅ mm	□	lm	cd	✂	K	⌚	ON/OFF	📦	EAN	📦
8	E14	45	78	E	40			2.300	1.000		8	4000870 127087	127.08



Rot Rouge Rood



W	⊖	∅ mm	⇅ mm	□	lm	cd	✂	K	⌚	ON/OFF	📦	EAN	📦
25	E27	45	70	E	2				1.000		8	4000870 401316	401.31



W	⊖	∅ mm	⇅ mm	□	lm	cd	✂	K	⌚	ON/OFF	📦	EAN	📦
25	E14	45	76	E	2				1.000		8	4000870 401217	401.21



Gelb Jaune Geel



W	⊖	∅ mm	⇅ mm	□	lm	cd	✂	K	⌚	ON/OFF	📦	EAN	📦
25	E27	45	70	E	83				1.000		8	4000870 401323	401.32



W	⊖	∅ mm	⇅ mm	□	lm	cd	✂	K	⌚	ON/OFF	📦	EAN	📦
25	E14	45	76	E	83				1.000		8	4000870 401224	401.22



Grün Vert Groen



W	⊖	∅ mm	⇅ mm	□	lm	cd	✂	K	⌚	ON/OFF	📦	EAN	📦
25	E27	45	70	E	7				1.000		8	4000870 401330	401.33



W	⊖	∅ mm	⇅ mm	□	lm	cd	✂	K	⌚	ON/OFF	📦	EAN	📦
25	E14	45	76	E	7				1.000		8	4000870 401231	401.23



Blau Bleu Blauw



W	⊖	∅ mm	⇅ mm	□	lm	cd	✂	K	⌚	ON/OFF	📦	EAN	📦
25	E27	45	70	E	1				1.000		8	4000870 401347	401.34



W	⊖	∅ mm	⇅ mm	□	lm	cd	✂	K	⌚	ON/OFF	📦	EAN	📦
25	E14	45	76	E	1				1.000		8	4000870 401248	401.24





Imatt Dépoli Mat

W	⊖	∅ mm	⇅ mm	□	lm	cd	✂	K	⌚	ON/OFF	📦	EAN	📦
8	E27	35	95	E	40			2.300	1.000	4000	10	4000870 444085	444.08

W	⊖	∅ mm	⇅ mm	□	lm	cd	✂	K	⌚	ON/OFF	📦	EAN	📦
8	E14	35	97	E	40			2.300	1.000	4000	10	4000870 449080	449.08



Rot Rouge Rood



W	⊖	∅ mm	⇅ mm	□	lm	cd	✂	K	⌚	ON/OFF	📦	EAN	📦
25	E14	35	98	E	2				1.000		10	4000870 402214	402.21



Gelb Jaune Geel



W	⊖	∅ mm	⇅ mm	□	lm	cd	✂	K	⌚	ON/OFF	📦	EAN	📦
25	E14	35	97	E	83				1.000		10	4000870 402221	402.22



Grün Vert Groen



W	⊖	∅ mm	⇅ mm	□	lm	cd	✂	K	⌚	ON/OFF	📦	EAN	📦
25	E14	35	98	E	7				1.000		10	4000870 402238	402.23



Blau Bleu Blauw



W	⊖	∅ mm	⇅ mm	□	lm	cd	✂	K	⌚	ON/OFF	📦	EAN	📦
25	E14	35	98	E	1				1.000		10	4000870 402245	402.24



Klar Clair Helder



W	⊖	∅ mm	⇅ mm	□	lm	cd	✂	K	⌚	ON/OFF	📦	EAN	📦
3	E27	35	95	E	1				1.000		10	4000870 531006	531.00



Klar Clair Helder



W	⊖	∅ mm	⇅ mm	□	lm	cd	✂	K	⌚	ON/OFF	📦	EAN	📦
3	E14	35	97	E	1				1.000		10	4000870 530009	530.00

Klar Clair Helder



W	⊖	∅ mm	⇅ mm	□	lm	cd	✂	K	⌚	ON/OFF	📦	EAN	📦
3	E14	35	130	E	1				1.000		10	4000870 530030	530.03







Rot Rouge Rood



W	⊖	∅ mm	⇅ mm	◻	lm	cd	✕	K	⌚	ON/OFF	📦	EAN	📦
25	E27	55	95	E	2				1.000		6	4000870 400210	400.21
40	E27	55	95	E	2				1.000		6	4000870 400418	400.41



Gelb Jaune Geel



W	⊖	∅ mm	⇅ mm	◻	lm	cd	✕	K	⌚	ON/OFF	📦	EAN	📦
25	E27	55	95	E	83				1.000		6	4000870 400227	400.22
40	E27	55	95	E	65				1.000		6	4000870 400425	400.42



Grün Vert Groen



W	⊖	∅ mm	⇅ mm	◻	lm	cd	✕	K	⌚	ON/OFF	📦	EAN	📦
25	E27	55	95	E	7				1.000		6	4000870 400234	400.23
40	E27	55	95	E	7				1.000		6	4000870 400432	400.43



Blau Bleu Blauw



W	⊖	∅ mm	⇅ mm	◻	lm	cd	✕	K	⌚	ON/OFF	📦	EAN	📦
25	E27	55	95	E	1				1.000		6	4000870 400241	400.24
40	E27	55	95	E	1				1.000		6	4000870 400449	400.44



Anti Insecta

Gelb Jaune Geel



W	⊖	∅ mm	⇅ mm	◻	lm	cd	✕	K	⌚	ON/OFF	📦	EAN	📦
60	E27	55	95	E	328				1.000		6	4000870 460603	460.60





Rot Rouge Rood



W	⊖	∅ mm	⇅ mm	◁	lm	cd	⚡	K	⌚	ON/OFF	📦	EAN	📦
60	E27	80	115	E	76		80		1.000		5	4000870 250617	250.61
40	E27	63	102	E	40		35		1.000		6	4000870 230411	230.41
25	E14	50	85	E	23		35		1.000		8	4000870 201213	201.21



Gelb Jaune Geel



W	⊖	∅ mm	⇅ mm	◁	lm	cd	⚡	K	⌚	ON/OFF	📦	EAN	📦
60	E27	80	115	E	279		80		1.000		5	4000870 250624	250.62
40	E27	63	102	E	146		35		1.000		6	4000870 230428	230.42
25	E14	50	85	E	89		35		1.000		8	4000870 201220	201.22



Grün Vert Groen



W	⊖	∅ mm	⇅ mm	◁	lm	cd	⚡	K	⌚	ON/OFF	📦	EAN	📦
60	E27	80	115	E	84		80		1.000		5	4000870 250631	250.63
40	E27	63	102	E	30		35		1.000		6	4000870 230435	230.43
25	E14	50	85	E	33		35		1.000		8	4000870 201237	201.23



Blau Bleu Blauw



W	⊖	∅ mm	⇅ mm	◁	lm	cd	⚡	K	⌚	ON/OFF	📦	EAN	📦
60	E27	80	115	E	15		80		1.000		5	4000870 250648	250.64
40	E27	63	102	E	7		35		1.000		6	4000870 230442	230.44
25	E14	50	85	E	6		35		1.000		8	4000870 201244	201.24





Schwarzlicht Lumière noire Blacklight



W	⊖	∅ mm	⇅ mm	◻	lm	cd	⚡	K	⌚	ON/OFF	📦	EAN	☑
75	E27	55	95						1.000		6	4000870 590706	590.70



Schwarzlicht Lumière noire Blacklight



W	⊖	∅ mm	⇅ mm	◻	lm	cd	⚡	K	⌚	ON/OFF	📦	EAN	☑
75	E27	80	116						1.000		5	4000870 591703	591.70

- ▶ Infrarot
- ▶ Nicht für medizinische Anwendungen.
- ▶ Betrieb nur in Leuchten mit Schutzglas zulässig.
- ▶ Nach vorn strahlt brillantes Halogenlicht, nach hinten satinfarben schimmernde Reflexionen. Nicht für Allgemeinbeleuchtung, nur für Spezialanwendung!

- ▶ Infrarouge
- ▶ Ne convient pas aux applications médicales.
- ▶ Fonctionnement autorisé uniquement dans les luminaires avec verre de protection.
- ▶ Émet une lumière halogène brillante vers l'avant et des reflets lumineux vers l'arrière. Ne convient pas à l'éclairage des pièces de vie, uniquement pour applications spécifiques!

- ▶ Infrarood
- ▶ Niet voor medische toepassingen.
- ▶ Gebruik alleen in armaturen met beveiligingsglas toegestaan.
- ▶ Naar voren straalt briljant halogeenlicht, naar achteren satijnkleurige, fonkelende reflecties. Niet voor algemene verlichting, alleen voor speciale toepassingen!



Rot Rouge Rood



W	⊖	∅ mm	⇅ mm	◻	lm <sub>/90°</sub>	cd	⚡	K	⌚	ON/OFF	📦	EAN	☑
40	E14	50	85	E	50		35	1.500	1.000	4000	8	4000870 829806	829.80
50	E14	45	71	E	50		120	1.500	1.000	4000	8	4000870 829790	829.79
25	E14	39	66	E	20		120	1.500	1.000	4000	8	4000870 829783	829.78



Rot Rouge Rood



W	⊖	∅ mm	⇅ mm	◻	lm	cd	⚡	K	⌚	ON/OFF	📦	EAN	☑
100	E27	95	134	E	64		80		1.000		4	4000870 829660	829.66
60	E27	80	115	E	26		80		1.000		5	4000870 829776	829.77
40	E27	63	102	E	25		35		1.000		6	4000870 829769	829.76





TV - Blau TV - Bleu TV - blauw



W	⊖	∅ mm	⇅ mm	◻	lm	cd	✂	K	⌚	ON/OFF	⊞	EAN	⊞
15	E14	25	60	E	20				1.000		16	4000870 810101	810.10



300° Klar 300° Clair 300° Helder



W	⊖	∅ mm	⇅ mm	◻	lm	cd	✂	K	⌚	ON/OFF	⊞	EAN	⊞
15	E14	22	50	E	85			2.300	1.000		16	4000870 820100	820.10
25	E14	25	55	E	125			2.200	1.000	4000	16	4000870 820117	820.11



300° Klar 300° Clair 300° Helder



W	⊖	∅ mm	⇅ mm	◻	lm	cd	✂	K	⌚	ON/OFF	⊞	EAN	⊞
25	E14	45	75	E	185			2.300	1.000	4000	8	4000870 820209	820.20
40	E14	45	75	E	389			2.700	1.000		8	4000870 820407	820.40



300°/Opal 300°/Opale 300°/Opaal



W	⊖	∅ mm	⇅ mm	◻	lm	cd	✂	K	⌚	ON/OFF	⊞	EAN	⊞
25	E14	45	78	E	160			2.700	1.000		8	4000870 106211	106.21
40	E14	45	78	E	300			2.700	1.000		8	4000870 106419	106.41



Klar Clair Helder

















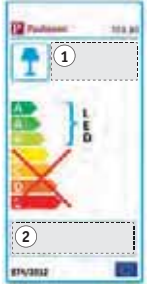

W	⊖	∅ mm	⇅ mm	◻	lm	cd	✂	K	⌚	ON/OFF	⊞	EAN	⊞
15	BA15d	16	47	E	75			2.300	1.000		16	4000870 808108	808.10

Das Etikett zur Energieeffizienzklasse wird wie folgt dargestellt:

L'étiquette pour la classe d'efficacité énergétique est représentée comme suit :

Het etiket voor energie-efficiëntieklasse wordt als volgt weergegeven:

	Beispiel Exemple Voorbeeld	①  Leuchte Luminaire Voorbeeld	②  Leuchtmittel Ampoules Lampen
	<b>Arctus</b>  max. 60 W, E27 230 V ⌀80 ⌀275 mm EAN 4000870 703458 <b>703.45</b>	Diese Leuchte ist geeignet für Leuchtmittel der Energieklassen <b>A+-E</b> . Ce luminaire est compatible avec des ampoules des classes énergétiques <b>A+-E</b> . In deze armatuur passen lampen van energieklassen <b>A+-E</b> .	
	<b>Futura</b>  incl. 2x3,5 W, GU10,  230 V ⌀150 ⇄275 ⌀80 mm EAN 4000870 601792 <b>601.79</b>	Diese Leuchte ist geeignet für Leuchtmittel der Energieklassen <b>A-E</b> . Ce luminaire est compatible avec des ampoules des classes énergétiques <b>A-E</b> . In deze armatuur passen lampen van energieklassen <b>A-E</b> .	Diese Leuchte wird verkauft mit einem Leuchtmittel der Energieklasse <b>A</b> . Le luminaire est vendu avec une ampoule de la classe énergétique <b>A</b> . De armatuur wordt verkocht met een lamp van energieklasse <b>A</b> .
	<b>Orbit</b>  incl. 1x18,5 W 1100 lm, 3000 K 230 V ⌀360 ⌀57 mm EAN 4000870 703908 <b>703.90</b>	Diese Leuchte enthält eingebaute LED-Lampen. Ce luminaire comporte des lampes à LED intégrées. Deze armatuur bevat ingebouwde LED-lampen.	Die Lampen können in der Leuchte nicht ausgetauscht werden. Les lampes de ce luminaire ne peuvent pas être changées. In de armatuur kunnen de lampen niet worden vervangen.
	<b>HaloLED</b>   incl. 4x20 W, GU4,  / 3x1,5 W 4x167 lm, 2900 K ✕ 30°, 500 cd 230/12 V, 105 VA ⌀160 mm 2,5 mm <sup>2</sup> ⇄12 m EAN 4000870 940709 <b>940.70</b>	Diese Leuchte enthält eingebaute LED-Lampen und hat Fassungen für Leuchtmittel der Energieklassen <b>B-D</b> . Ce luminaire comporte des lampes à LED intégrées et des douilles pour ampoules des classes énergétiques <b>B-D</b> . Deze armatuur bevat ingebouwde LED-lampen en heeft fittingen voor lampen van energieklassen <b>B-D</b> .	Diese Leuchte wird verkauft mit einem Leuchtmittel der Energieklasse <b>C</b> . Le luminaire est vendu avec une ampoule de la classe énergétique <b>C</b> . De armatuur wordt verkocht met een lamp van energieklasse <b>C</b> .

	Beispiel Exemple Voorbeeld	③  Leuchtmittel Ampoules Lampen												
	<table border="1" style="width: 100%; text-align: center;"> <thead> <tr> <th>⌀ mm</th> <th>⌀ mm</th> <th>⌀ mm</th> <th>lm</th> </tr> </thead> <tbody> <tr> <td>E27</td> <td>66</td> <td>130</td> <td>A 820</td> </tr> <tr> <td>E27</td> <td>60</td> <td>110</td> <td>A 500</td> </tr> </tbody> </table>	⌀ mm	⌀ mm	⌀ mm	lm	E27	66	130	A 820	E27	60	110	A 500	Energieeffizienzklasse: <b>A</b> Classe d'efficacité énergétique: <b>A</b> Energie-efficiëntieklasse: <b>A</b>
⌀ mm	⌀ mm	⌀ mm	lm											
E27	66	130	A 820											
E27	60	110	A 500											

Produkte ohne Angabe der Energieeffizienzklasse fallen nicht in den Anwendungsbereich der EU-VO 874/2012.

Les produits sans indications de classe énergétique ne relève pas du champ d'application du Règlement Européen 874/2012.

Producten zonder vermelding van de energie-efficiëntieklasse vallen niet onder EU-VO 874/2012.



Socket – Bauform – Lichttechnik  
 Culot – forme – technologie  
 Fitting – model – lichttechniek

 <b>E27</b>	  <b>LED</b>  <b>Energy Saver</b>  <b>Halogen 230V</b>  <b>Classic</b>	 <b>GU10</b>	  <b>LED</b>  <b>Energy Saver</b>  <b>Halogen 230V</b>
 <b>E14</b>	  <b>LED</b>  <b>Energy Saver</b>  <b>Halogen 230V</b>  <b>Classic</b>	 <b>GZ10</b>	  <b>Halogen 230V</b>
 <b>B22d</b>	  <b>Halogen 230V</b>	 <b>G4</b>	  <b>LED</b>  <b>Halogen 12V</b>
 <b>BA15d</b>	  <b>Classic</b>	 <b>GY6,35</b>	  <b>LED</b>  <b>Halogen 12V</b>
 <b>GU4</b>	  <b>LED</b>  <b>Halogen 12V</b>	 <b>G9</b>	  <b>LED</b>  <b>Halogen 230V</b>
 <b>GU5,3</b>	  <b>LED</b>  <b>Halogen 12V</b>	 <b>R7s</b>	  <b>LED</b>  <b>Halogen 230V</b>



Lumenvergleich  
 Comparaison des lumens  
 Lumenvergelijking

Paulmann LED-Leuchtmittel ersparen mindestens 80% der Leistungsaufnahme einer herkömmlichen Glühlampe.

Sie erfüllen die Anforderungen der Effizienzklasse A, A+ oder A++.

So ersetzt zum Beispiel die LED-Lampe 282.98 mit der Effizienzklasse A+ eine 60 W-Glühlampe. Bei gleicher Helligkeit verbraucht sie aber nur 9,5 Watt.

Les ampoules LED Paulmann vous font économiser au moins 80 % de la puissance absorbée d'une ampoule à incandescence traditionnelle.







Elles sont conformes aux classes d'efficacité énergétique A, A+ ou A++.

Par exemple, l'ampoule LED 282.98 de la classe d'efficacité énergétique A+ remplace une ampoule à incandescence 60 W. Pour une même luminosité, elle ne consomme que 9,5 watts.

Paulmann-LED-lichtbronnen zijn ten minste 80% zuiniger dan de gewone gloeilamp.

Ze voldoen aan de eisen van de efficiëntieklasse A, A+ of A++.

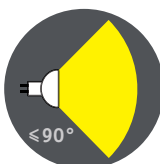
Zo vervangt bijvoorbeeld de LED-lamp 282.98 met de efficiëntieklasse A+ een gloeilamp van 60 W. Bij dezelfde helderheid verbruikt deze slechts 9,5 watt.

	Lichttechnik Technologie d'éclairage Lichttechniek	(Glüh-) Lampe Watt Ampoule (à incandescence) Watt (Gloeilamp) watt	LED Helligkeit in Lumen Luminosité LED en lumens LED-helderheid in lumen	
Rundumstrahler Omnidirectionnels Rondomstralers 	Glühlampe Klassik Ampoule à incandescence classique Gloeilamp klassiek  <b>E14, E27, GU10</b>	15 W	140 lm	
		25 W	250 lm	
		40 W	470 lm	
		60 W	806 lm	
		75 W	1055 lm	
		100 W	1521 lm	
	Halogen 230V <b>G9, E27, R7s</b> 	25 W	250 lm	
		40 W	470 lm	
		60 W	806 lm	
	Halogen 12V  <b>G4, GY6,35</b>	5 W	45 lm	
		10 W	90 lm	
		20 W	190 lm	
		35 W	390 lm	
		50 W	630 lm	
	Reflektorlampen Lampes à réflecteur Reflectorlampen 	Halogen 230V <b>E14, E27, GU10</b> 	25 W	125 lm
			35 W	200 lm
			50 W	300 lm
		Halogen 12V <b>GU4, GU5,3</b> 	10 W	80 lm/90 lm (GU4/GU5,3)
20 W			160 lm/180 lm (GU4/GU5,3)	
35 W			300 lm	
50 W			540 lm	

LED statt Halogen – Austausch bei Hochvolt-Lampen (230V):

LED contre halogène – Substitution en cas d'ampoules haute tension (230 V) :

LED in plaats van halogeen – vervanging van hoogspanningslampen (230 V):

- |  |  |   |
|--|--|---|
| <ol style="list-style-type: none"> <li>1. Wählen Sie die gewünschte Bauform!</li> <li>2. Suchen Sie Ihre Fassung aus!</li> <li>3. Soll die Lampe dimmbar sein?</li> <li>4. Wählen Sie die gewünschte Helligkeit (Watt/Lumen). Berücksichtigen Sie bitte hierbei die Mindestlast bei Trafos.</li> <li>5. Welche Lichtfarbe soll die Lampe haben?</li> </ol> | <ol style="list-style-type: none"> <li>1. Choisissez le modèle souhaité</li> <li>2. Trouvez le bon culot</li> <li>3. La lampe doit-elle être gradable ?</li> <li>4. Choisissez la luminosité souhaitée (watt/lumen). Veuillez bien tenir compte dans ce cas de la charge minimale des transformateurs.</li> <li>5. Quelle température de couleur devrait avoir la lampe ?</li> </ol> | <ol style="list-style-type: none"> <li>1. Kies de gewenste bouwvorm!</li> <li>2. Zoek uw fitting uit!</li> <li>3. Moet de lamp dimbaar zijn?</li> <li>4. Kies de gewenste helderheid (Watt/lumen). Houd hierbij rekening met de minimumlast bij trafo's.</li> <li>5. Welke lichtkleur moet de lamp hebben?</li> </ol> |
|--|--|---|



LED statt Halogen – Austausch von Niedervolt-Lampen (12V):  
 LED contre halogène – Substitution en cas d'ampoules très basse tension (12 V) :  
 LED in plaats van halogeen – vervanging van laagspanningslampen (12 V):

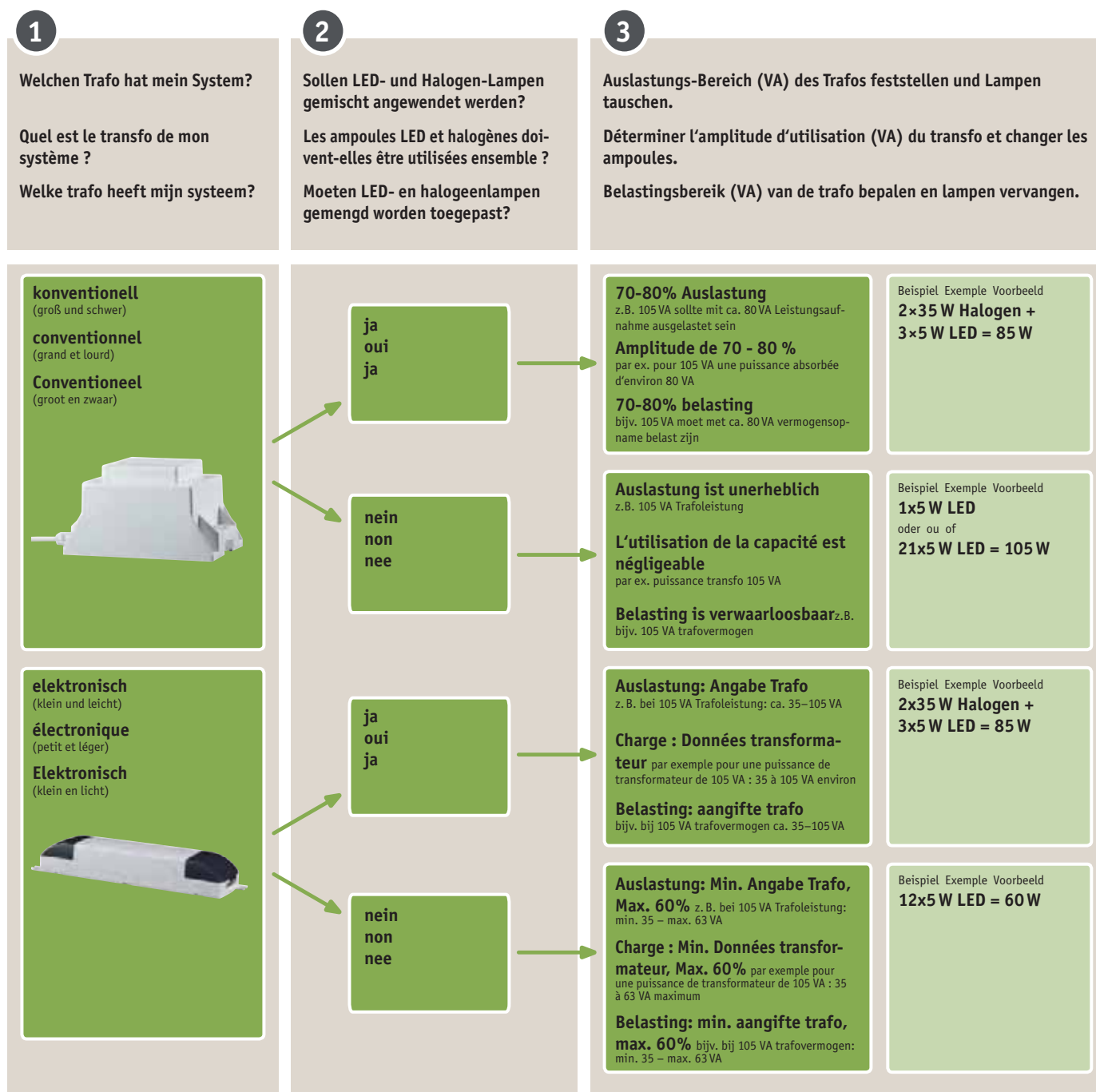

Der Wert von 1 VA (Volt-Ampere) bei der Vorgabe für die Trafoleistung entspricht 1 W (Watt) Leistungsaufnahme der Lampen.  
 La puissance du transfo (VA) correspond à la puissance en Watt (W) absorbée par les ampoules.  
 De waarde van 1 VA (voltampère) bij de specificatie voor het trafovermogen komt overeen met 1W (Watt) vermogensopname van de lampen.

Trafo für LED: die Universallösung  
 Transformateur pour LED : la solution universelle  
 Trafo voor LED: de universele oplossing

Sollten die neuen LED-Lampen nicht die Mindestlast des Trafos erreichen, empfehlen wir einen neuen elektronischen Trafo, der die Leistung von 0-40 Watt (bei LED) aufnimmt. Art-Nr. 977.67

Si les nouvelles lampes LED n'atteignent pas la charge minimale du transformateur, nous vous en recommandons un nouveau, électronique qui accepte une charge variant de 0 à 40W (dans le cas de LED). N° d'article 977.67

Als de nieuwe LED-lampen de minimumlast van de trafo niet dienen te bereiken, dan adviseren wij een nieuwe elektronische trafo te gebruiken, die het vermogen van 0-40 W (bij LED) opneemt. Art-nr. 977.67





## Dimmerkennzeichnung Identification variateur Dimmer kenmerking

In einer Installation muss der richtige Dimmer zur richtigen Lampe bzw. Leuchte passen.

Die Kennzeichen (**R, L, C, LED...**) oder deren Kombinationen definieren Dimmer, Trafos und Lampen.

Für die richtige Auswahl des Dimmers müssen die entsprechenden Kennzeichen auf dem Dimmer, Trafo oder der Lampe übereinstimmen.

- Für LED Produkte benötigen Sie einen LED Dimmer der entweder mit dem PhasenANSchnitt- Prinzip



oder PhasenABSchnitt-Prinzip



arbeitet.

(Kennzeichen **LED, HV-LED, LEDi**)

- Für Halogen 12V Lampen mit elektronischem Trafo normalerweise ein PhasenABSchnittdimmer



(**R, C**)

- Für Halogen 12V Lampen mit konventionellem Trafo ein PhasenANSchnittdimmer.



(**R, L**)

- Glühlampen und Halogenlampen 230V können Sie mit jedem Dimmer dimmen.



(**R / R, L / R, C / R, L, C**)

Leuchten, die ohne Leuchtmittel und gegebenenfalls ohne Vorschaltgerät ausgeliefert werden, sind deklariert mit z.B. „max. 40W“. Sind diese Leuchten dimmbar, sind sie deklariert mit



Die Dimmbarkeit ist jedoch abhängig von der Art der verwendeten Leuchtmittel und gegebenenfalls des Vorschaltgeräts. Hier finden Sie weiterführende Informationen: [www.paulmann.com/productdata](http://www.paulmann.com/productdata)

Dans une installation, il est important d'adapter le bon variateur à la bonne ou aux bonnes ampoules.

Les désignations (**R, L, C, LED...**) ou leur combinaison définissent les variateurs, les transformateurs et les ampoules.

Pour choisir le bon variateur, les désignations correspondantes sur le variateur, le transformateur et sur l'ampoule doivent correspondre.

- Les produits LED requièrent un variateur LED d'intensité fonctionnant sur le principe de découpage de début de phase



ou de découpage de fin de phase



(Désignations **LED, HV-LED, LEDi**)

- Pour les ampoules halogènes 12 V avec transformateur électronique, un variateur à découpage de fin de phase est généralement requis



(**R, C**)

- Pour les ampoules halogènes 12V avec transformateur conventionnel, un variateur à découpage de début de phase est requis.



(**R, L**)

- Tous les variateurs conviennent pour faire varier l'intensité des ampoules halogènes et à incandescence 230 V.



(**R / R, L / R, C / R, L, C**)

Les luminaires livrés sans ampoules et éventuellement sans ballast portent une mention comme par ex. « max. 40W ». Si ces luminaires sont gradables, ils portent la mention



La variation d'intensité dépend toutefois du type d'ampoules utilisées et, le cas échéant, du ballast. Pour davantage d'informations, rendez-vous à la page [www.paulmann.com/productdata](http://www.paulmann.com/productdata)

In een installatie moet de juiste dimmer bij de juiste lamp of armatuur passen.

De merktekens (**R, L, C, LED...**) of combinaties daarvan definiëren dimmer, trafo's en lampen.

Voor de juiste keuze van de dimmer moeten de betreffende merktekens op dimmer, trafo of lamp overeenkomen.

- Voor LED-producten hebt u een LED-dimmer nodig die ofwel met het faseaansnijdingsprincipe



of het faseafsnijdingsprincipe



werkt.

(merktekens **LED, HV-LED, LEDi**)

- Voor halogeenlampen 12 V met elektronische trafo gewoonlijk een faseafsnijdingsdimmer



(**R, C**)

- Voor halogeenlampen 12 V met conventionele trafo een faseaansnijdingsdimmer.



(**R, L**)

- Gloeilampen en halogeenlampen 230 V kunt u met elke dimmer dimmen.



(**R / R, L / R, C / R, L, C**)

Armaturen, die zonder verlichtingsmiddel en eventueel zonder voorschakelapparaat geleverd worden, zijn aangeduid met bv. „max. 40W“. Indien deze armaturen dimbaar zijn, worden ze aangeduid met



De dimbaarheid is echter afhankelijk van het gebruikte verlichtingsmiddel en eventueel van het voorschakelapparaat Meer informatie vindt u hier: [www.paulmann.com/productdata](http://www.paulmann.com/productdata)



**Leitungsquerschnitte 12 V**  
**Sections de fils 12 V**  
**Leidingdoorsnedes 12 V**

Bestimmung des Leitungsquerschnittes  
 Détermination de la section de fil électrique  
 Bepalen van de leidingdoorsnede

Lampenleistung Puissance de la lampe Lampvermogen	Leitungslänge Longueur du fil électrique Leidinglengte				
	2,5 m	5,0 m	7,5 m	10,0 m	15 m
	Leitungsquerschnitt mm <sup>2</sup> Section du fil électrique mm <sup>2</sup> Leidingdoorsnede mm <sup>2</sup>				
20 W	0,75	0,75	1,5	1,5	2,5
50 W	1	2,5	4	4	6
100 W	2,5	4	6		
150 W	4	6			
200 W	4				
250 W	6				
300 W	6				

Nur für Zuleitungen zu Verteilungen, nicht für Seilssysteme.  
 Berechnet für Spannungsabfall 3%. Bei elektronischen Trafos maximale Leitungslänge 2 m.

Convient uniquement pour les fils d'alimentation destinés à la distribution, mais pas pour les systèmes de câbles.  
 Calculé pour une chute de tension de 3%. Pour les transformateurs électroniques : longueur maximale du fil électrique 2 m.

Uitsluitend voor toevoerleidingen naar verdelers, niet voor kabelsystemen.  
 Berekend voor spanningsafval 3%. Bij elektronische trafo's maximale leidinglengte 2 m.

Empfohlene Leitungsquerschnitte für 12 V Seilssysteme  
 Sections recommandées des fils électriques pour des systèmes de câbles de 12 V  
 Aanbevolen leidingdoorsnede voor 12 kabelsystemen

Lampenleistung Puissance de la lampe Lampvermogen	Seillänge Longueur de câble Kabellengte	
	< 5 m	> 5 – 10 m
	Leitungsquerschnitt mm <sup>2</sup> Section du fil électrique mm <sup>2</sup> Leidingdoorsnede mm <sup>2</sup>	
< 150 W	2,5	–
> 150 – 300 W	–	4





Seilssysteme dürfen keine höhere Leistung als 300 W haben!  
 Bei höherem Leistungsbedarf Seiltrenner einsetzen und damit zwei Stromkreise bilden! Seiloptik bleibt erhalten.

La puissance des systèmes de câbles ne doit pas dépasser 300 W !  
 S'il faut une puissance supérieure, installer un séparateur de câble pour former deux circuits électriques ! L'aspect esthétique des câbles n'en est nullement altéré.

Kabelsystemen mogen geen hoger vermogen hebben dan 300 W!  
 Als een hoger vermogen noodzakelijk is, de spankabels scheiden, zodat er twee stroomcircuits ontstaan! Optisch blijft het kabelsysteem behouden.

**Trafoauslastung**  
**Utilisation à pleine charge du transformateur**  
**Trafobelasting**

Wie können Trafos mit zulässiger Auslastung bestückt werden?  
 Comment les transformateurs peuvent-ils offrir la capacité autorisée d'utilisation à pleine charge ?  
 Hoe kunnen trafo's optimaal gebruikt worden?

Trafo VA	 10 W	 20 W	 35 W	 50 W
60 VA	6 x 10 W	3 x 20 W	1 x 35 W 3 x 20 W	1 x 50 W
70 VA	7 x 10 W	3 x 20 W 1 x 10 W	2 x 35 W	1 x 50 W 1 x 20 W
80 VA	8 x 10 W	4 x 20 W	2 x 35 W 1 x 10 W	1 x 50 W 3 x 10 W
105 VA	10 x 10 W	5 x 20 W	3 x 35 W	2 x 50 W
150 VA	15 x 10 W	7 x 20 W 1 x 10 W	4 x 35 W 1 x 10 W	3 x 50 W
200 VA	20 x 10 W	10 x 20 W	5 x 35 W 1 x 20 W	4 x 50 W
210 VA	21 x 10 W	10 x 20 W 1 x 10 W	6 x 35 W	4 x 50 W 1 x 10 W
250 VA	25 x 10 W	12 x 20 W 1 x 10 W	7 x 35 W	5 x 50 W
300 VA	30 x 10 W	15 x 20 W	8 x 35 W 1 x 20 W	6 x 50 W

Schutzbereiche Parties protégées Beschermde zones

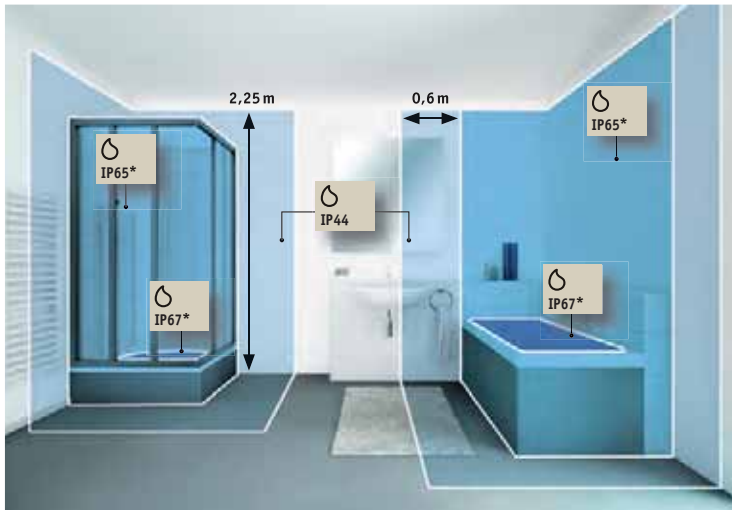

**IP68** Wasserdicht bei dauerhaftem Untertauchen (\* und 12V/24 V Schutzkleinspannung)  
 Protection contre l'immersion permanente (\* et 12 V/24 V très basse tension de sécurité)

Waterdicht bij permanente onderdompeling (\* en 12 V/24 V beveiliging lage spanning)

**IP67** Wasserdicht bei zeitweiligem Untertauchen (\* und 12V/24 V Schutzkleinspannung)  
 Étanche à l'immersion temporaire (\* et 12 V/24 V très basse tension de sécurité)

Waterdicht bij tijdelijke onderdompeling (\* en 12 V/24 V beveiliging lage spanning)

**IP65** Strahlwassergeschützt bei direktem Wasserstrahl (\* und 12V/24 V Schutzkleinspannung)  
 Protection contre les jets d'eau directs (\* et 12 V/24 V très basse tension de sécurité)

Beschermde tegen rechtstreekse waterstralen (\* en 12 V/24 V beveiliging lage spanning)

**IP44** Spritzwassergeschützt  
 Protection contre les projections d'eau  
 Spatwaterdicht

**IP23** Sprühwassergeschützt  
 Protection contre les aspersion d'eau  
 Regenwaterdicht

**IP...** Die IP Schutzart ist nur bei Deckenmontage gültig.  
 Classes de protection IP pour tous les appareils électriques.  
 IP-beveiligingsklassen voor alle elektrische bedrijfsmiddelen.

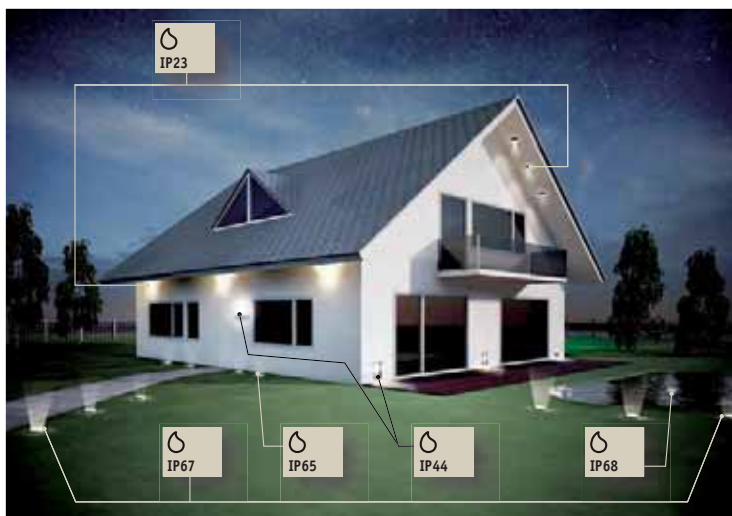

**D Räume mit elektrischen Anlagen nach DIN VDE 0100 T.701 (Bereiche gelten bis Raumhöhe 2,25 m)**

In der Decke dürfen nur Leuchten eingebaut werden, die durch eine festangebrachte Glasscheibe abgedeckt sind oder der Betrieb mit Schutzkleinspannung erfolgt.

Die Sicherheitsstromquelle muss außerhalb der markierten Bereiche angeordnet sein und es muss ein Schutz gegen direktes Berühren stromdurchflossener Teile vorhanden sein. Kabel und Leitungen bis 5 cm unter Putz: nur senkrechte Verlegung und Kabeleinführung in die Rückseite der Leuchte.

**Länder außerhalb Deutschlands:** Die exakt einzuhaltenden Maße sowie die Einschätzung der Bereiche muss gemäß nationaler Installationsvorschriften von einer örtlichen Elektrofachkraft vorgenommen werden.

**D Pièces contenant des installations électriques conformes à la norme DIN VDE 0100 T.701 (zones valables pour hauteur de plafond 2,25 m)**

Dans le plafond, les éclairages ne doivent être encastrés que s'ils sont recouverts par une vitre en verre bien fixée ou si le fonctionnement s'effectue avec une très basse tension de sécurité.

La source de courant de sécurité doit se trouver en dehors des zones marquées et il doit y avoir une protection contre le contact direct des parties traversées par le courant. Câbles et fils encastrés jusqu'à 5 cm de profondeur : uniquement pose verticale et passage de câbles dans le dos de la lampe.

**Pays autres que l'Allemagne :** Les dimensions à respecter et l'évaluation des zones doivent être réalisées par un électricien local dans le respect des normes d'installation nationales.

**D Ruimtes met elektrische installaties conform DIN VDE 0100 T.701 (bereiken gelden tot ruimtehoogte 2,25 m)**

In het plafond mogen alleen lampen worden ingebouwd die door vast aangebracht glas zijn afgedekt of met beveiligde lage spanning worden gebruikt.

De veiligheidsstroombron moet buiten de gekenmerkte bereiken zijn gemonteerd en er moet een beveiliging tegen direct aanraken van stroomgeleidende delen voorhanden zijn. Kabels en leidingen tot 5 cm ingebouwd: alleen verticale montage en kabelinvoer in de achterzijde van de lamp.

**Landen buiten Duitsland:** Een lokale electricien dient de exact na te leven maten te bepalen en de bereiken in te schatten volgens de nationale installatierichtlijnen.

Wie hell ist die Lampe?  
Quelle est la clarté de l'ampoule ?  
Hoe sterk is de lamp?

Helligkeit bei Rundumstrahlern  
Luminosité d'un éclairage diffus  
Helderheid bij rondomspots



**Die Maßeinheit Lumen (lm)** gibt mit dem Lichtstrom die gesamte Lichtmenge an, die eine rundumstrahlende Lampe abgibt.

**Le Lumen (lm)** est l'unité de mesure du flux lumineux émanant d'une lampe éclairant à 360°.

**De eenheid lumen (lm)** geeft met de lichtstroom de totale lichthoeveelheid aan die een stralende lamp afgeeft.

Helligkeit bei Reflektorlampen  
Luminosité d'un réflecteur  
Helderheid bij reflectorlampen

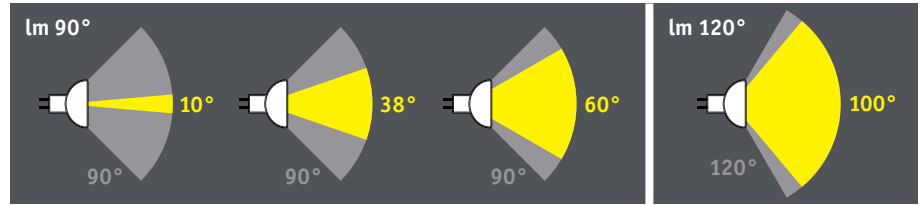

Alle Reflektorlampen mit einem Ausstrahlwinkel bis max. 90° sind mit Lichtstrom im 90°-Winkel ausgezeichnet und sind somit vergleichbar. Es wird die Helligkeit innerhalb des 90°-Winkels gemessen, auch wenn der tatsächliche Ausstrahlwinkel kleiner ist.

Alle Reflektorlampen mit einem Ausstrahlwinkel von 91° bis max. 120° sind mit dem Wert Lichtstrom im 120°-Winkel ausgezeichnet. Diese Leuchtmittel sind nicht für Akzentbeleuchtung geeignet.

Alle Leuchtmittel mit einem größeren Ausstrahlwinkel als 120° gelten als „nicht gerichtetes Licht“ und werden mit dem Wert Lichtstrom (Lumen, lm) ausgezeichnet, der in den kompletten 360° um das Leuchtmittel herum ermittelt wird.

Die verschiedenen Maßeinheiten Lumen (lm), Lumen im 90°-Winkel (lm90°) und Lumen im 120°-Winkel (lm120°) sind nicht miteinander vergleichbar.

Tous les réflecteurs avec un faisceau lumineux de max. 90° se voient attribuer un flux lumineux mesuré dans un angle de 90° permettant ainsi la comparaison entre les produits. La mesure de la luminosité est réalisée dans un angle de 90°, même si le faisceau effectif du produit est inférieur.

Tous les réflecteurs avec un faisceau lumineux compris entre 91° et 120° se voient attribuer un flux lumineux mesuré dans un angle de 120°. Ces sources lumineuses ne sont pas adaptées pour un éclairage d'accentuation.

Tous les réflecteurs avec un faisceau lumineux supérieur 120° sont considérés comme un éclairage non-directionnel et se voient attribuer un flux lumineux (Lumen, lm) mesuré dans un angle de 360° autour de la source.

Les différentes unités de mesures Lumen (lm), Lumen dans un angle de 90° (lm90°) et Lumen dans un angle de 120° (lm120°) ne sont pas comparables entre elles.

Alle reflectorlampen met een uitstraalhoek tot max. 90° zijn gekenmerkt met lichtstroom in 90°-hoek en dus vergelijkbaar. Gemeten wordt de helderheid binnen de 90°-hoek, ook als de werkelijke uitstraalhoek kleiner is.

Alle reflectorlampen met een uitstraalhoek van 91° tot max. 120° zijn gekenmerkt met lichtstroom in 120°-hoek. Deze lampen zijn niet geschikt voor accentverlichting.

Alle lampen met een grotere uitstraalhoek dan 120° gelden als „niet-gericht licht“ en worden met de waarde lichtstroom (lumen, lm) gekenmerkt die in de complete 360° rond de lamp wordt bepaald.

De verschillende maateenheden lumen (lm), lumen in 90°-hoek (lm90°) en lumen in 120°-hoek (lm120°) kunnen niet met elkaar worden vergeleken.



Gewünschte Lichtfarbe?  
Couleur d'éclairage souhaitée?  
Gewenste lichtkleur?

## Candela

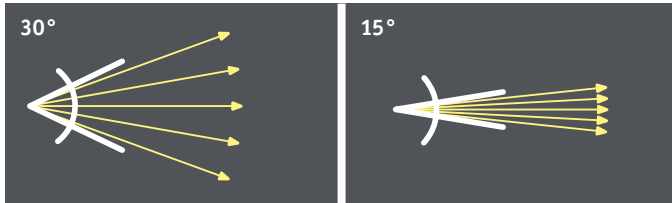

Größerer Ausstrahlwinkel, geringere Lichtstärke

Angle de rayonnement plus grand, moins de puissance lumineuse

Grote uitstraalhoek, zwakke lichtsterkte

Kleinerer Ausstrahlwinkel, höhere Lichtstärke

Angle de rayonnement plus petit, plus de puissance lumineuse

Kleine uitstraalhoek, hoge lichtsterkte

**Die Maßeinheit Candela (cd)** gibt die Lichtstärke von gebündeltem Licht an, wie es Reflektorlampen erzeugen. Reflektorlampen bündeln den Lichtstrom in einem bestimmten Ausstrahl-Winkel (Angabe in Grad). Je kleiner der Winkel, desto stärker die Bündelung und desto höher der Candela-Wert.

**La Candela (cd)** est l'unité de mesure d'intensité d'une lumière focalisée, telle le faisceau lumineux émis par les réflecteurs. Les réflecteurs concentrent le flux lumineux dans un angle de rayonnement défini (donnée en degré). Plus l'angle est petit, plus la concentration est forte et plus la valeur en Candela est élevée.

**De eenheid candela (cd)** geeft de lichtsterkte van gebundeld licht aan, die reflectorlampen opwekken. Reflectorlampen bundelen de lichtstroom in een bepaalde uitstraalhoek (aanduiding in graden). Hoe kleiner de hoek, des te sterker is de bundeling en des te hoger de candela-waarde.

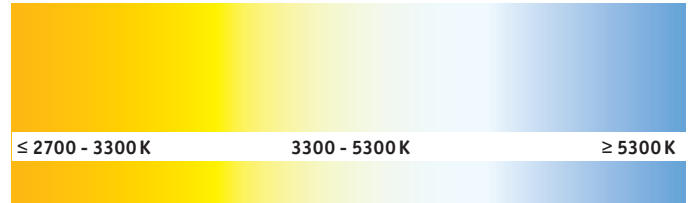

Warmweiß  
Blanc chaud  
Warm wit

Neutralweiß  
Blanc neutre  
Neutraal wit

Tageslichtweiß  
blanc lumière du jour  
Daglicht wit

**Die Farbtemperatur** wird in der Einheit Kelvin (K) angegeben und beschreibt, ob das weiße Licht eher gelblich-warm oder bläulich-kühl ist. Warmweißes Licht gleicht dem späten Tageslicht, es wirkt gemütlich und entspannend. Neutralweißes Licht wirkt aktivierend, Tageslichtweiß fördert die Konzentration.

**La température de couleur** est mesurée en Kelvin (K) et décrit si la lumière blanche est chaude teintée jaune ou froide teintée bleu. La lumière blanc chaud est agréable, relaxante et ressemble à la lumière de fin de journée. La lumière blanche naturelle est énergisante, ressemble à la lumière du jour et favorise la concentration.

**De kleurtemperatuur** wordt in de eenheid Kelvin (K) aangeduid en bepaalt, of het witte licht eerder warmgeel of koelblauw is. Warmwit licht lijkt op laat daglicht; het is behaaglijk en het ontspant. Neutraalwit licht werkt stimulerend, daglichtwit bevordert de concentratie.



	☐		☐		☐
1Flame . . . . .	.277	Bowl . . . . .	.104	Drilled Alu . . . . .	334,347
2Easy . . . . .	.391	Buislamp . . . . .	.466	Drop . . . . .	38,111
2Flame . . . . .	.277	Butler . . . . .	.102	Duo Profil . . . . .	.223
2Line . . . . .	.126	Calami . . . . .	.100	Edge . . . . .	.303
AR 111 . . . . .	.418	Calma . . . . .	.41	Edla . . . . .	.51
Abhängung . . . . .	142-143,168	Calotte . . . . .	427,436,440	Einbautopf . . . . .	.394
Ace . . . . .	.234	Cameo . . . . .	.41	Einspeisung . . . . .	143,169
Adaptateur . . . . .	393,395-396	Cardan . . . . .	.137	Elia . . . . .	.51
Adapter E27-GU10 . . . . .	.464	Cardano . . . . .	.348	Encastrés sol . . . . .	. . . . .
Adapter . . . . .	393,395-396	Circlips . . . . .	.396	250,252-253,255,258,285,289,291,294-	. . . . .
Agema . . . . .	.33	Clear . . . . .	.105	296,292292	. . . . .
Akzent . . . . .	.460	Coimbra . . . . .	.122	Erdspieß . . . . .	.250,297
Alimentation électrique . . . . .	143,169	Coin . . . . .	311-323,392,416	Esben . . . . .	.47
AmbientLED . . . . .	.282	Colmar . . . . .	.138	Eske . . . . .	.51
Ampoule infrarouge . . . . .	.473	Comet . . . . .	.138	Even . . . . .	366-370
Anti Insecta . . . . .	.471	Connecteur . . . . .	.169	Falima . . . . .	.28
Ardora . . . . .	.15	Cornus . . . . .	.86	Fassung . . . . .	.395
Argun . . . . .	.17	Costella . . . . .	.16	Favia . . . . .	.85
Arik . . . . .	.83	CosyLight . . . . .	463,465,470	Filament . . . . .	426,434,444-445
Assistent II LED . . . . .	.102	Couvercle encastré . . . . .	.394	Finja . . . . .	.102
Attache boucles . . . . .	.142	Cover . . . . .	.262	Fitting . . . . .	.395
Aufbauleuchte . . . . .	377-378,380-381,388	Cubik . . . . .	.118	Flackerkerze . . . . .	.470
Aufbauring . . . . .	.309	Curvus . . . . .	.101	Flakkerkaars . . . . .	.470
Backofen . . . . .	.474	Câble de tension . . . . .	.142	Flamme scintillante . . . . .	.470
Badkamerlamp . . . . .	19-21,25,27,29-38	DC Spot Lense . . . . .	.134	FlexLED . . . . .	208-209
Badleuchte . . . . .	19-21,25,27,29-38	DecoBeam . . . . .	.21	Fliesenleuchte . . . . .	305-306
Bakoven . . . . .	.474	DecoDice . . . . .	.353	Floor Profil 1m . . . . .	.226
Barre lumière . . . . .	.138	DecoDot . . . . .	.353	Four . . . . .	.474
Basic . . . . .	.139	DecoPipe . . . . .	433,453,464	Frame . . . . .	.107
Basissystem . . . . .	.134	Decopipe . . . . .	433,453,464	Frigo . . . . .	.445
Beam Fifty . . . . .	96-97	Delta Profil . . . . .	.225	Galacta . . . . .	.41
Beam Sixty . . . . .	96-97	Deon . . . . .	.123	Galeria LED II . . . . .	.101
Beam Thirty . . . . .	96-97	Diamond . . . . .	.421	Galeria . . . . .	98-99
Beam . . . . .	.23	Dilja . . . . .	.46	Garden Spot . . . . .	284,287
Benue . . . . .	.91	Disc . . . . .	.454	Gate . . . . .	.376
Biabo . . . . .	.26	DiscLED I . . . . .	.133	Gesa . . . . .	.102
Big Flame . . . . .	.277	DiscLED II . . . . .	.134	Giba . . . . .	.93
Blacklight . . . . .	.473	Distributeur . . . . .	261,293	Glint . . . . .	.356
Block . . . . .	.97	Dot . . . . .	.352	Globe . . . . .	.41
Bodeminbouwlampen . . . . .	. . . . .	Double . . . . .	.118	Glow . . . . .	.234
250,252-253,255,258,285,289,291,294-	. . . . .	Douille GZ10 pour ampoules GU/GZ10 . . . . .	.464	Grondpen . . . . .	250,297
296,292292	. . . . .	Douille . . . . .	.395	Gutta . . . . .	.84
Bodeneinbauleuchten . . . . .	. . . . .	Dress . . . . .	.379	Halo+ . . . . .	.464
250,252-253,255,258,285,289,291,294-	. . . . .	DressLight Battery . . . . .	.240	HaloLED . . . . .	.136
296,292292	. . . . .	DressLight . . . . .	.239	Hausnummer . . . . .	274,294



	☐		☐		☐
Helix . . . . .	.117	Liao . . . . .	17	PIR-Sensor . . . . .	.199
Hemisphere . . . . .	.105	Lichtstab . . . . .	.138	Panel . . . . .	.363-365,369-373
Hexa . . . . .	.418	Lichtstaf . . . . .	.138	Pendel Aufnahme . . . . .	67
Huisnummer . . . . .	274,294	Linienlampen . . . . .	.446	Pendel . . . . .	61,71,76
Iben . . . . .	51	Linja . . . . .	46	Pendelaufhängung . . . . .	67
IceLED I . . . . .	133,174	LinkLight . . . . .	.238	Pendelophanging . . . . .	67
IceLED II . . . . .	133,174	Lisboa . . . . .	.121	Pflanzenwachstum . . . . .	.423
Inbouwpot . . . . .	.394	Liseuse . . . . .	.100	Pinja . . . . .	94
Infrarood . . . . .	.473	Luke . . . . .	.126	Piquet à planter . . . . .	250,297
Infraroodlamp . . . . .	.473	Luminaire de salle de bains 19-21,25,27,29-38		Plantengroei . . . . .	.423
Infrarot . . . . .	.473	Luminaire en saillie . . . . .	377-378,380-381,388	Plattern . . . . .	.377
Infrarotlampe . . . . .	.473	Luminaire pour carrelage . . . . .	305-306	Plaza . . . . .	94
Infrarouge . . . . .	.473	Luminaires de miroir . . . . .	.100	Pole . . . . .	.108
Iro . . . . .	.123	Lumix . . . . .	.233	Pollerleuchte . . . . .	.257
Ivy . . . . .	.22-23	Lumière noire . . . . .	.473	Porto . . . . .	.121
Ixa . . . . .	27	Lunar . . . . .	.12-13	Pousse-plantes . . . . .	.423
Jenni . . . . .	93	Mac II . . . . .	135-136	Power Supply . . . . .	.409
JetLine . . . . .	.236	MacLED . . . . .	.132	Profiel . . . . .	228-230
Jiggle . . . . .	.242	Machine á coudre . . . . .	.474	Profil . . . . .	228-230
Juwel . . . . .	459-460	Mari . . . . .	18	Profilé . . . . .	228-230
Kabelblok . . . . .	.143	MaxLED . . . . .	178-180,182-189,232	QPAR 111 . . . . .	.422
Kabelklem . . . . .	.142	Maxiflood . . . . .	.417-418,421,458-459,464	QuadLED . . . . .	.173
Kelt . . . . .	88	Mea . . . . .	18	QuadLed . . . . .	.173
Kiia . . . . .	93	Meli . . . . .	.115	Quadro . . . . .	.304,339,418,460
Kine . . . . .	46	Menja . . . . .	47	Rail . . . . .	.168
Kit de Culot . . . . .	.462	Meta . . . . .	.135	Rallonge . . . . .	.293
Kit de traction . . . . .	142-143	Mic . . . . .	.106	Ramos . . . . .	83
Kite . . . . .	.379	Micro . . . . .	.288	Renvoi d'angle . . . . .	142-143
Klemmspot . . . . .	.102	Mini electronic . . . . .	452,454	Rolling . . . . .	.357
Klemspot . . . . .	.102	Mini . . . . .	.291	Rondo . . . . .	.114
Klipp Klapp . . . . .	.386	MiniPlus . . . . .	.290	Rotate . . . . .	242-243
Koelkast . . . . .	.445	Mobil Strip . . . . .	.220	RoundMac . . . . .	.132
Kopfspiegel . . . . .	427,436,440	Naaimachine . . . . .	.474	Röhrenlampe . . . . .	.466
Kopspiegel . . . . .	427,436,440	Narve . . . . .	49	Sabik . . . . .	.30,83
Kura . . . . .	92	Nova . . . . .	.324	Sabot contact . . . . .	.143
Kühlschrank . . . . .	.445	Numéro de maison . . . . .	274,294	Salt . . . . .	.137
LED Driver . . . . .	412-413	Nähmaschine . . . . .	.474	Sara . . . . .	94
Lagoon . . . . .	.110	Ogma . . . . .	.119	Schiene . . . . .	.168
Launcher . . . . .	.108	Olar . . . . .	47	Schwarzlicht . . . . .	.473
Layer . . . . .	.351	Ombuiger . . . . .	142-143	Security . . . . .	458-459
Leaf . . . . .	.375	Opbouwlamp . . . . .	377-378,380-381,388	Seilklemmen . . . . .	.142
Leeslamp . . . . .	.100	Opbouwing . . . . .	.309	Seilklotz . . . . .	.143
Lenny . . . . .	.126	Ophanging . . . . .	142-143,168	Seja . . . . .	92
Leonis . . . . .	26	Outdoor . . . . .	249,251,254,259-260,270,273-276	SenseLight . . . . .	.239
Leseleuchte . . . . .	.100	PAR38 . . . . .	.423	Set Mac II . . . . .	135-136



	☐		☐
Set Sheela . . . . .	.137	TV . . . . .	468,474
Shell . . . . .	.351	Tegellamp . . . . .	305-306
ShiftLED . . . . .	.146	Teja Flex . . . . .	.116
SimplLED . . . . .	217-218	Teja . . . . .	116-117
Simplo . . . . .	.101	Tessa . . . . .	90
SkyLight . . . . .	.357	Tiril . . . . .	61
Slice . . . . .	.104	Togo . . . . .	.138
Slide bar . . . . .	.243	Tom . . . . .	.126
Smart Coin . . . . .	358-359	Tona . . . . .	51
SmartHome . . . . .	130,190,205-207,360,400,402-404,449	Trafo. . . . .	.409
SmartLight. . . . .	.243	Transformateur . . . . .	.409
SnapLED . . . . .	.241	TriX . . . . .	.235
Socketset. . . . .	.462	Tube . . . . .	39,111,273
Sokkelset. . . . .	.462	Tubes fluorescent . . . . .	.466
Sol . . . . .	14	Tumbler. . . . .	.109
Span-montageset . . . . .	142-143	URail . . . . .	153,162,166-172
Spankabel . . . . .	.142	USB-Strips . . . . .	219-221
Spann-Montageset. . . . .	142-143	Umlenker . . . . .	142-143
Spannseil. . . . .	.142	Vala . . . . .	46
Special Line LED Allround . . . . .	.308	Vane . . . . .	.376
Special Line Wall LED . . . . .	.281	Veerring . . . . .	.396
Spice Salt. . . . .	.137	Verbinder. . . . .	.169
Spiegellamp . . . . .	.100	Verbinding . . . . .	.169
Spiegelleuchte . . . . .	.100	Verdeler. . . . .	261,293
Spiraal . . . . .	.454	Verlenging . . . . .	.293
Spirale . . . . .	.454	Verloopstuk E27 - GU10 . . . . .	.464
Spot Emma . . . . .	.127	Verlängerung . . . . .	.293
Spot Lynn . . . . .	.127	Verteiler . . . . .	261,293
Spot Mac II . . . . .	.135	Verve . . . . .	41
Spot Mary . . . . .	.127	Vilma . . . . .	93
Spot Sheela . . . . .	.137	Vitrino . . . . .	.101
Spot à pince . . . . .	.102	Voeding. . . . .	143,169
Spotlight Georgia. . . . .	.116	WaterLED . . . . .	215-216
Spotlight Turn. . . . .	112-113	WaveLine . . . . .	.246
Sprengring . . . . .	.396	Whirl . . . . .	349-350,381
Square Profil. . . . .	.228	Window . . . . .	.107
Squarelense . . . . .	.106	WolbaLED. . . . .	.113
Stage . . . . .	.135,174	Yasmin . . . . .	.114
Starter . . . . .	.456	YourLED ECO . . . . .	192-193
Stian . . . . .	46	YourLED. . . . .	192-197,199-204,213
Support tubes . . . . .	142-143,168	Zala . . . . .	.122
Support. . . . .	.309	Zed LED . . . . .	94
Suspension. . . . .	.61,67,71,76	Zyli. . . . .	39,111
Système de base . . . . .	.134	Zylo . . . . .	.115
		easyClick2 . . . . .	.344





<u>106.21</u>	474	<u>280.91</u>	417	<u>283.55</u>	421	<u>284.26</u>	429	<u>284.90</u>	447	<u>3980</u>	131	<u>500.20</u>	400
<u>106.41</u>	474	<u>281.10</u>	445	<u>283.56</u>	445	<u>284.27</u>	439	<u>284.92</u>	431	<u>3981</u>	131	<u>500.21</u>	449
<u>127.08</u>	469	<u>281.11</u>	445	<u>283.57</u>	445	<u>284.28</u>	426	<u>284.93</u>	431	<u>3982</u>	131	<u>500.38</u>	205
<u>128.08</u>	469	<u>281.12</u>	419	<u>283.62</u>	430	<u>284.29</u>	420	<u>284.94</u>	431	<u>3983</u>	132	<u>500.39</u>	205
<u>178.03</u>	142	<u>281.70</u>	429	<u>283.63</u>	429	<u>284.30</u>	420	<u>284.95</u>	430	<u>400.17</u>	465	<u>500.43</u>	403
<u>178.06</u>	142	<u>281.71</u>	429	<u>283.64</u>	430	<u>284.31</u>	417	<u>284.96</u>	431	<u>400.18</u>	465	<u>500.44</u>	403
<u>178.14</u>	142	<u>281.79</u>	419	<u>283.65</u>	430	<u>284.32</u>	419	<u>284.97</u>	431	<u>400.21</u>	471	<u>500.45</u>	190
<u>178.24</u>	143	<u>282.19</u>	421	<u>283.66</u>	430	<u>284.33</u>	420	<u>284.98</u>	431	<u>400.22</u>	471	<u>500.46</u>	190
<u>178.34</u>	143	<u>282.24</u>	420	<u>283.67</u>	440	<u>284.34</u>	420	<u>284.99</u>	431	<u>400.23</u>	471	<u>500.47</u>	190
<u>179.43</u>	340	<u>282.44</u>	426	<u>283.68</u>	440	<u>284.35</u>	433	<u>285.00</u>	441	<u>400.24</u>	471	<u>500.48</u>	205
<u>179.45</u>	340	<u>282.45</u>	426	<u>283.69</u>	440	<u>284.36</u>	433	<u>285.01</u>	441	<u>400.25</u>	465	<u>500.49</u>	205
<u>179.46</u>	340	<u>282.54</u>	422	<u>283.70</u>	440	<u>284.39</u>	447	<u>285.02</u>	441	<u>400.26</u>	465	<u>500.50</u>	171
<u>179.51</u>	341	<u>282.60</u>	417	<u>283.71</u>	430	<u>284.40</u>	447	<u>285.03</u>	441	<u>400.27</u>	465	<u>500.51</u>	171
<u>179.53</u>	341	<u>282.69</u>	438	<u>283.72</u>	430	<u>284.41</u>	447	<u>285.04</u>	441	<u>400.28</u>	465	<u>500.52</u>	450
<u>179.54</u>	341	<u>282.75</u>	417	<u>283.73</u>	427	<u>284.42</u>	447	<u>285.05</u>	432	<u>400.29</u>	465	<u>500.53</u>	450
<u>179.55</u>	341	<u>282.76</u>	417	<u>283.74</u>	427	<u>284.43</u>	447	<u>285.06</u>	432	<u>400.30</u>	465	<u>500.54</u>	450
<u>180.00</u>	279	<u>282.77</u>	417	<u>283.75</u>	427	<u>284.44</u>	423	<u>285.07</u>	431	<u>400.41</u>	471	<u>500.55</u>	450
<u>180.01</u>	279	<u>282.85</u>	421	<u>283.76</u>	427	<u>284.45</u>	423	<u>285.08</u>	431	<u>400.42</u>	471	<u>500.56</u>	450
<u>180.02</u>	279	<u>282.86</u>	421	<u>283.77</u>	427	<u>284.46</u>	419	<u>285.09</u>	419	<u>400.43</u>	471	<u>500.57</u>	450
<u>180.03</u>	279	<u>282.87</u>	417	<u>283.78</u>	427	<u>284.47</u>	437	<u>285.10</u>	419	<u>400.44</u>	471	<u>500.61</u>	450
<u>180.04</u>	277	<u>282.90</u>	419	<u>283.79</u>	435	<u>284.48</u>	428	<u>285.13</u>	432	<u>401.21</u>	469	<u>500.62</u>	450
<u>180.05</u>	277	<u>282.91</u>	429	<u>283.80</u>	435	<u>284.49</u>	428	<u>285.14</u>	422	<u>401.22</u>	469	<u>500.63</u>	450
<u>180.06</u>	277	<u>282.92</u>	429	<u>283.81</u>	435	<u>284.50</u>	428	<u>285.15</u>	418	<u>401.23</u>	469	<u>500.64</u>	360
<u>180.07</u>	277	<u>282.93</u>	439	<u>283.82</u>	440	<u>284.51</u>	428	<u>285.17</u>	425	<u>401.24</u>	469	<u>500.65</u>	360
<u>180.08</u>	278	<u>282.94</u>	439	<u>283.83</u>	440	<u>284.52</u>	428	<u>285.18</u>	425	<u>401.31</u>	469	<u>500.66</u>	404
<u>180.09</u>	278	<u>282.95</u>	439	<u>283.84</u>	440	<u>284.55</u>	440	<u>285.20</u>	425	<u>401.32</u>	469	<u>500.67</u>	402
<u>180.10</u>	261	<u>282.96</u>	439	<u>283.85</u>	440	<u>284.56</u>	427	<u>285.21</u>	442	<u>401.33</u>	469	<u>500.68</u>	361
<u>180.11</u>	261	<u>282.97</u>	426	<u>283.86</u>	437	<u>284.57</u>	436	<u>285.22</u>	442	<u>401.34</u>	469	<u>500.71</u>	362
<u>201.21</u>	472	<u>282.98</u>	426	<u>283.87</u>	436	<u>284.58</u>	444	<u>285.23</u>	442	<u>402.21</u>	470	<u>500.72</u>	362
<u>201.22</u>	472	<u>282.99</u>	420	<u>283.88</u>	437	<u>284.59</u>	444	<u>285.24</u>	443	<u>402.22</u>	470	<u>500.73</u>	362
<u>201.23</u>	472	<u>283.00</u>	420	<u>283.89</u>	437	<u>284.60</u>	423	<u>285.25</u>	443	<u>402.23</u>	470	<u>500.74</u>	121
<u>201.24</u>	472	<u>283.01</u>	418	<u>283.90</u>	444	<u>284.61</u>	423	<u>285.26</u>	443	<u>402.24</u>	470	<u>500.75</u>	121
<u>202000223</u>	396	<u>283.02</u>	446	<u>283.91</u>	444	<u>284.63</u>	420	<u>285.27</u>	448	<u>404000125</u>	396	<u>500.76</u>	122
<u>202000224</u>	396	<u>283.03</u>	446	<u>283.92</u>	444	<u>284.64</u>	420	<u>285.28</u>	448	<u>404000126</u>	396	<u>500.77</u>	122
<u>216</u>	395	<u>283.04</u>	446	<u>283.94</u>	444	<u>284.65</u>	418	<u>285.29</u>	448	<u>404000752</u>	396	<u>500.78</u>	121
<u>217</u>	395	<u>283.05</u>	446	<u>283.95</u>	444	<u>284.66</u>	418	<u>285.30</u>	448	<u>404000753</u>	396	<u>500.79</u>	121
<u>218.9</u>	395	<u>283.25</u>	418	<u>283.98</u>	426	<u>284.67</u>	439	<u>285.31</u>	448	<u>404001963</u>	396	<u>500.80</u>	207
<u>228</u>	396	<u>283.26</u>	418	<u>283.99</u>	443	<u>284.68</u>	439	<u>285.32</u>	426	<u>444.08</u>	470	<u>500.81</u>	207
<u>229</u>	396	<u>283.27</u>	433	<u>284.00</u>	443	<u>284.69</u>	438	<u>285.33</u>	419	<u>449.08</u>	470	<u>500.82</u>	11
<u>230</u>	394	<u>283.28</u>	433	<u>284.01</u>	443	<u>284.70</u>	424	<u>285.35</u>	419	<u>460.60</u>	471	<u>500.83</u>	11
<u>230.41</u>	472	<u>283.29</u>	417	<u>284.02</u>	443	<u>284.71</u>	424	<u>285.36</u>	421	<u>500.01</u>	400	<u>500.84</u>	11
<u>230.42</u>	472	<u>283.30</u>	418	<u>284.03</u>	443	<u>284.72</u>	425	<u>285.37</u>	439	<u>500.02</u>	190	<u>500.85</u>	11
<u>230.43</u>	472	<u>283.31</u>	427	<u>284.04</u>	443	<u>284.73</u>	445	<u>285.38</u>	429	<u>500.03</u>	190	<u>500.86</u>	11
<u>230.44</u>	472	<u>283.32</u>	427	<u>284.05</u>	443	<u>284.74</u>	429	<u>285.39</u>	446	<u>500.04</u>	190	<u>500.87</u>	11
<u>232</u>	286	<u>283.33</u>	440	<u>284.06</u>	443	<u>284.75</u>	427	<u>285.40</u>	446	<u>500.05</u>	206	<u>500.94</u>	402
<u>233</u>	396	<u>283.34</u>	440	<u>284.07</u>	443	<u>284.76</u>	440	<u>285.42</u>	444	<u>500.06</u>	358	<u>500.95</u>	403
<u>236</u>	394	<u>283.35</u>	430	<u>284.09</u>	420	<u>284.77</u>	448	<u>285.43</u>	426	<u>500.07</u>	358	<u>500.96</u>	122
<u>237</u>	286	<u>283.36</u>	417	<u>284.10</u>	420	<u>284.78</u>	436	<u>285.44</u>	437	<u>500.08</u>	10	<u>500.97</u>	122
<u>250</u>	394	<u>283.37</u>	438	<u>284.11</u>	445	<u>284.79</u>	441	<u>285.45</u>	436	<u>500.09</u>	10	<u>500.98</u>	123
<u>250.61</u>	472	<u>283.38</u>	419	<u>284.12</u>	445	<u>284.80</u>	441	<u>285.46</u>	436	<u>500.10</u>	10	<u>500.99</u>	123
<u>250.62</u>	472	<u>283.39</u>	439	<u>284.13</u>	445	<u>284.81</u>	441	<u>285.47</u>	436	<u>500.11</u>	449	<u>501.00</u>	123
<u>250.63</u>	472	<u>283.40</u>	429	<u>284.14</u>	445	<u>284.82</u>	441	<u>285.48</u>	434	<u>500.12</u>	449	<u>501.01</u>	123
<u>250.64</u>	472	<u>283.41</u>	423	<u>284.15</u>	446	<u>284.83</u>	441	<u>285.49</u>	434	<u>500.13</u>	449	<u>501.02</u>	92
<u>280.00</u>	418	<u>283.42</u>	419	<u>284.16</u>	446	<u>284.84</u>	434	<u>285.50</u>	434	<u>500.14</u>	449	<u>501.03</u>	403
<u>280.07</u>	422	<u>283.43</u>	419	<u>284.17</u>	446	<u>284.85</u>	438	<u>285.51</u>	424	<u>500.15</u>	449	<u>501.07</u>	129
<u>280.10</u>	422	<u>283.48</u>	426	<u>284.18</u>	420	<u>284.86</u>	438	<u>285.52</u>	424	<u>500.16</u>	130	<u>501.08</u>	129
<u>280.11</u>	421	<u>283.49</u>	426	<u>284.23</u>	426	<u>284.87</u>	437	<u>314.65</u>	466	<u>500.17</u>	400	<u>501.09</u>	129
<u>280.48</u>	421	<u>283.50</u>	426	<u>284.24</u>	434	<u>284.88</u>	437	<u>314.66</u>	466	<u>500.18</u>	400	<u>501.10</u>	130
<u>280.49</u>	418	<u>283.51</u>	429	<u>284.25</u>	444	<u>284.89</u>	447	<u>314.67</u>	466	<u>500.19</u>	400	<u>501.11</u>	129



501.12	129	603.51	141,150	666.76	112	702.00	198,410	704.02	236	704.98	241	706.39	243
501.13	129	603.52	141,150	666.78	114	702.01	198,410	704.03	239	704.99	240	706.40	243
501.14	130	603.77	104	666.79	114	702.02	196	704.04	239	705.00	241	706.41	13
501.15	130	603.80	104	666.80	114	702.03	203	704.05	246	705.01	240	706.42	13
501.16	171	603.81	104	666.81	114	702.04	202	704.06	246	705.08	25	706.43	13
501.17	171	603.82	104	666.82	113	702.08	195	704.07	213	705.09	25	706.44	13
501.18	449	603.83	104	666.83	113	702.09	195	704.08	213	705.10	213	706.45	13
503.22	67	603.85	104	666.84	113	702.10	194	704.09	226	705.11	213	706.46	13
503.23	67	603.86	104	666.85	113	702.15	202	704.10	226	705.12	213	706.47	13
503.28	61	660.52	93	666.86	115	702.21	223	704.13	215	705.67	184	706.48	12
503.32	76	666.18	118	666.87	115	702.45	94	704.14	215	705.68	182	706.49	12
503.35	71	666.19	118	666.88	115	702.47	204	704.15	215	705.69	182	706.50	12
503.41	67	666.20	118	666.89	115	702.51	202	704.16	215	705.70	184	706.51	12
503.42	67	666.21	118	666.90	114	702.52	192	704.17	215	705.74	188	706.52	12
503.43	67	666.30	105	666.91	114	702.53	192	704.18	215	705.75	188	706.53	12
510.42	465	666.31	105	666.92	114	702.54	193	704.19	215	705.76	188	706.54	12
510.43	465	666.32	105	666.93	115	702.55	193	704.28	193	705.77	178	706.55	12
510.44	465	666.33	105	666.94	115	702.56	193	704.29	193	705.78	179	706.56	12
510.46	465	666.34	108	666.95	115	702.57	193	704.30	192	705.79	178	706.57	185
513.28	465	666.35	108	666.96	115	702.61	225	704.39	227	705.80	179	706.63	180
513.29	465	666.36	108	666.97	116	702.62	225	704.40	227	705.81	178	706.64	180
530.00	470	666.37	108	666.98	116	702.63	225	704.41	227	705.82	179	706.65	180
530.03	470	666.38	107	666.99	116	702.64	225	704.42	227	705.85	182	706.66	180
531.00	470	666.39	107	667.00	116	702.65	225	704.44	239	705.86	182	706.67	180
540.23	466	666.40	107	667.01	116	702.66	225	704.45	236	705.87	184	706.68	180
540.24	466	666.41	107	667.02	117	702.67	223	704.46	236	705.88	182	706.69	183
549.16	462	666.42	106	667.03	117	702.68	223	704.47	235	705.89	182	706.70	183
549.17	462	666.43	106	667.04	117	702.69	223	704.48	235	705.91	198	706.71	183
549.18	462	666.44	106	667.05	117	702.70	223	704.51	199,414	705.92	195	706.72	183
549.19	462	666.45	106	667.06	116	702.71	223	704.53	223	705.93	195	706.73	185
549.20	462	666.46	110	667.07	116	702.72	223	704.55	220	705.94	194	706.74	185
549.21	462	666.47	110	667.08	116	702.73	223	704.56	220	705.95	237	706.75	183
549.26	462	666.48	110	667.09	116	702.74	223	704.57	220	705.96	237	706.76	183
549.27	462	666.49	110	667.10	39,111	702.75	223	704.58	193	705.97	237	706.83	189
549.28	462	666.50	106	667.11	39,111	702.82	203	704.59	193	705.98	237	706.84	189
549.29	464	666.51	106	667.12	39,111	702.84	238	704.60	192	705.99	203	706.85	189
5792	343	666.52	106	667.13	39,111	702.85	238	704.61	197	706.04	178	706.86	22
5796	343	666.53	106	667.14	38,111	702.91	21	704.63	33	706.05	179	706.87	22
590.70	473	666.54	108	667.15	38,111	703.09	213	704.64	33	706.06	236	706.88	23
591.70	473	666.55	108	667.16	38,111	703.10	213	704.67	25	706.12	236	706.89	23
600.04	140,149	666.56	108	667.17	39,111	703.11	213	704.68	37	706.13	236	706.91	23
600.07	140,149	666.57	108	667.18	39,111	703.12	213	704.69	34	706.14	236	706.92	23
600.09	140,149	666.58	109	667.19	39,111	703.17	195	704.70	34	706.15	188	706.96	211
600.11	140,149	666.59	109	667.28	120	703.18	195	704.71	34	706.16	188	706.97	211
600.12	140,149	666.60	109	667.29	120	703.19	194	704.72	29	706.17	188	706.98	216
600.15	140,149	666.61	109	667.30	120	703.20	195	704.73	29	706.18	188	706.99	216
600.55	140,149	666.62	105	667.31	120	703.21	195	704.74	29	706.19	189	707.00	220
601.62	117	666.63	105	667.32	120	703.22	194	704.78	29	706.21	189	707.01	220
601.98	117	666.64	105	667.33	120	703.30	223	704.79	29	706.22	15	707.02	220
601.99	117	666.65	105	667.34	120	703.34	203	704.80	211	706.23	186	707.03	220
602.00	117	666.66	107	667.35	120	703.43	27	704.81	211	706.24	186	707.04	220
603.26	141,150	666.67	107	667.36	118	703.44	27	704.86	204	706.27	187	707.05	219
603.27	141,150	666.68	107	667.37	118	703.45	27	704.87	204	706.28	187	707.06	219
603.28	109	666.69	107	667.38	118	703.49	37	704.88	203	706.30	186	707.09	232
603.29	109	666.70	113	667.39	119	703.50	32	704.89	203	706.34	187	707.10	232
603.30	109	666.71	113	667.40	119	703.54	32	704.90	203	706.35	242	707.11	232
603.31	109	666.72	113	667.41	119	703.98	235	704.92	31	706.36	242	707.12	232
603.49	141,150	666.74	112	701.74	140,149	703.99	239	704.94	31	706.37	243	707.13	232
603.50	141,150	666.75	112	701.99	198,410	704.01	236	704.95	30	706.38	243	707.14	232

707.15	231	708.58	229	709.23	90	795.34	87	796.62	69	797.33	47	832.66	460
707.16	231	708.59	229	709.24	90	795.35	87	796.63	76	797.34	88	833.14	460
707.17	231	708.60	229	709.25	88	795.37	87	796.64	53	797.35	88	833.71	460
707.18	231	708.61	229	709.26	84	796.00	70	796.65	79	797.36	51	833.74	460
707.19	231	708.62	230	709.27	84	796.01	71	796.66	283	797.37	46	833.76	458
707.20	21	708.63	230	709.28	88	796.04	71	796.67	283	797.38	51	833.79	459
707.21	21	708.64	7	709.29	84	796.05	70	796.68	283	797.39	51	833.82	458
707.22	26	708.65	7	709.30	84	796.06	72	796.69	283	797.40	51	833.83	458
707.23	26	708.66	7	709.31	86	796.07	72	796.70	283	797.41	51	833.84	459
707.24	26	708.67	7	709.32	86	796.08	69	796.71	283	797.42	46	833.85	459
707.25	26	708.68	8	709.33	7	796.09	69	796.72	283	797.43	46	833.86	459
707.26	199	708.69	8	709.34	7	796.10	72	796.73	283	797.97	189	838.24	458
707.27	199	708.70	8	709.35	7	796.11	73	796.74	276	800.11	468	838.26	459
707.32	14	708.71	8	709.36	7	796.12	69	796.75	275	800.12	468	860.02	454
707.33	14	708.72	9	709.37	8	796.13	73	796.76	275	800.13	468	860.03	455
707.34	14	708.73	9	709.38	8	796.14	70	796.77	276	800.15	468	860.07	454
707.35	14	708.74	24	709.39	8	796.15	71	796.78	276	800.16	466	870.01	463
707.36	14	708.75	24	709.40	9	796.16	75	796.79	275	800.17	466	870.03	463
707.37	14	708.76	29	709.41	9	796.17	77	796.80	275	800.18	466	870.07	463
707.76	234	708.78	35	709.42	17	796.18	75	796.81	276	800.30	464	875.58	463
707.77	234	708.79	35	709.43	17	796.19	75	796.82	64	800.31	464	875.60	463
707.90	19	708.80	36	709.44	17	796.21	76	796.83	64	800.32	464	875.63	463
707.91	19	708.81	37	709.45	17	796.22	78	796.84	56	800.33	464	875.69	463
707.92	20	708.82	24	709.46	30,83	796.23	79	796.85	56	800.34	458	875.72	463
707.93	20	708.83	29	709.47	30,83	796.24	79	796.86	56	800.40	464	875.74	463
707.94	21	708.85	221	709.48	33	796.25	78	796.87	56	800.41	464	875.75	463
707.95	21	708.86	221	709.49	18	796.26	77	796.88	69	800.42	464	875.76	463
707.96	20	708.87	221	709.50	18	796.27	79	796.89	63	800.43	464	875.77	463
707.98	19	708.88	221	709.51	18	796.28	61	796.90	63	800.44	464	875.85	463
707.99	19	708.89	221	709.52	18	796.29	61	796.91	63	800.59	464	880.56	452
708.00	183	708.90	41	749.95	94	796.30	53	796.92	63	800.60	464	883.13	452
708.01	183	708.91	41	770.25	94	796.33	55	796.93	81	800.62	464	883.19	452
708.02	180	708.92	41	770.29	94	796.34	54	796.94	81	800.63	464	883.21	452
708.03	180	708.93	41	770.31	93	796.35	55	796.95	81	800.65	464	883.23	454
708.04	26	708.94	40	770.32	93	796.36	54	796.96	85	808.10	474	884.24	456
708.05	27	708.95	41	770.37	93	796.37	53	796.97	85	810.10	468,474	884.40	455
708.06	28	708.96	40	789.61	208	796.38	53	796.98	55	820.10	474	884.45	455
708.07	234	709.01	16	789.62	208	796.40	55	796.99	61	820.11	474	884.46	455
708.08	234	709.02	16	789.63	208	796.41	53	797.00	61	820.20	474	884.47	455
708.09	228	709.03	16	789.64	209	796.42	65	797.07	83	820.40	474	884.48	455
708.10	228	709.04	16	789.65	209	796.43	65	797.08	17	829.66	473	884.84	456
708.11	233	709.05	15	789.66	209	796.44	65	797.09	17	829.76	473	885.08	456
708.12	233	709.06	15	789.67	244	796.45	65	797.10	17	829.77	473	885.13	456
708.13	233	709.07	178	789.68	244	796.46	55	797.11	17	829.78	473	885.15	456
708.14	233	709.08	179	789.69	244	796.47	57	797.12	36	829.79	473	885.19	456
708.23	188,410	709.09	211	789.70	245	796.48	57	797.13	36	829.80	473	885.20	456
708.24	188,410	709.10	200	789.71	245	796.49	57	797.14	36	831.15	458	885.21	456
708.26	235	709.11	197	789.72	217	796.50	57	797.15	36	831.16	458	885.36	456
708.27	178	709.12	196	789.73	217	796.51	58	797.16	35	831.17	458	885.41	456
708.28	179	709.13	200	789.74	217	796.52	58	797.23	49	831.18	458	885.44	456
708.29	178	709.14	200	789.75	217	796.53	58	797.24	49	831.19	458	885.45	456
708.30	179	709.15	201	789.76	217	796.54	58	797.25	47	832.09	460	885.49	456
708.38	31	709.16	201	789.77	217	796.55	58	797.26	46	832.33	458	885.50	456
708.39	32	709.17	202	789.78	218	796.56	62	797.27	47	832.44	459	885.53	456
708.40	38	709.18	202	789.79	218	796.57	62	797.28	46	832.45	459	885.54	456
708.41	38	709.19	188	789.80	218	796.58	62	797.29	91	832.46	459	885.58	456
708.42	38	709.20	83	795.31	87	796.59	62	797.30	92	832.47	458	885.60	456
708.55	228	709.21	83	795.32	87	796.60	62	797.31	47	832.53	459	885.61	456
708.56	228	709.22	90	795.33	87	796.61	73	797.32	92	832.60	459	885.62	456



<u>885.63</u>	<u>456</u>	<u>927.33</u>	<u>353</u>	<u>929.53</u>	<u>368</u>	<u>936.44</u>	<u>390</u>	<u>937.85</u>	<u>290</u>	<u>938.72</u>	<u>313</u>	<u>939.41</u>	<u>358</u>
<u>890.20</u>	<u>452</u>	<u>927.34</u>	<u>353</u>	<u>929.54</u>	<u>368</u>	<u>936.45</u>	<u>390</u>	<u>937.86</u>	<u>290</u>	<u>938.73</u>	<u>313</u>	<u>939.42</u>	<u>311</u>
<u>892.39</u>	<u>454</u>	<u>927.35</u>	<u>350</u>	<u>935.11</u>	<u>379</u>	<u>936.47</u>	<u>355</u>	<u>937.87</u>	<u>291</u>	<u>938.74</u>	<u>313</u>	<u>939.43</u>	<u>311</u>
<u>892.40</u>	<u>454</u>	<u>927.86</u>	<u>318</u>	<u>935.12</u>	<u>379</u>	<u>936.48</u>	<u>354</u>	<u>937.88</u>	<u>285</u>	<u>938.75</u>	<u>315</u>	<u>939.44</u>	<u>311</u>
<u>894.09</u>	<u>453</u>	<u>927.87</u>	<u>318</u>	<u>935.14</u>	<u>379</u>	<u>936.49</u>	<u>333</u>	<u>937.89</u>	<u>292</u>	<u>938.76</u>	<u>315</u>	<u>939.45</u>	<u>311</u>
<u>894.11</u>	<u>453</u>	<u>928.01</u>	<u>363</u>	<u>935.47</u>	<u>381</u>	<u>936.50</u>	<u>333</u>	<u>937.90</u>	<u>290</u>	<u>938.77</u>	<u>315</u>	<u>939.46</u>	<u>311</u>
<u>894.19</u>	<u>453</u>	<u>928.02</u>	<u>363</u>	<u>935.52</u>	<u>384</u>	<u>936.51</u>	<u>332</u>	<u>937.91</u>	<u>274</u>	<u>938.78</u>	<u>315</u>	<u>939.47</u>	<u>311</u>
<u>894.39</u>	<u>454</u>	<u>928.97</u>	<u>324</u>	<u>935.53</u>	<u>384</u>	<u>936.52</u>	<u>332</u>	<u>937.96</u>	<u>285</u>	<u>938.79</u>	<u>315</u>	<u>939.48</u>	<u>416</u>
<u>902.00</u>	<u>146</u>	<u>928.98</u>	<u>324</u>	<u>935.54</u>	<u>384</u>	<u>936.53</u>	<u>332</u>	<u>937.97</u>	<u>285</u>	<u>938.80</u>	<u>315</u>	<u>939.49</u>	<u>252</u>
<u>902.02</u>	<u>146</u>	<u>928.99</u>	<u>324</u>	<u>935.55</u>	<u>384</u>	<u>936.54</u>	<u>332</u>	<u>938.05</u>	<u>396</u>	<u>938.81</u>	<u>317</u>	<u>939.50</u>	<u>252</u>
<u>902.03</u>	<u>146</u>	<u>929.00</u>	<u>324</u>	<u>935.56</u>	<u>384</u>	<u>936.55</u>	<u>335</u>	<u>938.06</u>	<u>396</u>	<u>938.82</u>	<u>317</u>	<u>939.51</u>	<u>252</u>
<u>902.04</u>	<u>146</u>	<u>929.01</u>	<u>327</u>	<u>935.61</u>	<u>375</u>	<u>936.56</u>	<u>335</u>	<u>938.08</u>	<u>280</u>	<u>938.83</u>	<u>317</u>	<u>939.52</u>	<u>252</u>
<u>902.05</u>	<u>146</u>	<u>929.02</u>	<u>327</u>	<u>935.62</u>	<u>375</u>	<u>936.57</u>	<u>335</u>	<u>938.09</u>	<u>280</u>	<u>938.84</u>	<u>416</u>	<u>939.53</u>	<u>253</u>
<u>902.06</u>	<u>146</u>	<u>929.03</u>	<u>325</u>	<u>935.63</u>	<u>377</u>	<u>936.58</u>	<u>335</u>	<u>938.10</u>	<u>395</u>	<u>938.85</u>	<u>416</u>	<u>939.54</u>	<u>253</u>
<u>920.31</u>	<u>379</u>	<u>929.04</u>	<u>325</u>	<u>935.64</u>	<u>377</u>	<u>936.59</u>	<u>335</u>	<u>938.11</u>	<u>282</u>	<u>938.86</u>	<u>392</u>	<u>939.55</u>	<u>320</u>
<u>920.32</u>	<u>376</u>	<u>929.05</u>	<u>348</u>	<u>935.66</u>	<u>378</u>	<u>936.60</u>	<u>335</u>	<u>938.12</u>	<u>282</u>	<u>938.87</u>	<u>392</u>	<u>939.56</u>	<u>320</u>
<u>920.33</u>	<u>376</u>	<u>929.06</u>	<u>348</u>	<u>935.67</u>	<u>378</u>	<u>936.61</u>	<u>324</u>	<u>938.13</u>	<u>282</u>	<u>938.88</u>	<u>316</u>	<u>939.57</u>	<u>320</u>
<u>920.58</u>	<u>369</u>	<u>929.07</u>	<u>349</u>	<u>935.72</u>	<u>380</u>	<u>936.62</u>	<u>324</u>	<u>938.14</u>	<u>282</u>	<u>938.89</u>	<u>316</u>	<u>939.58</u>	<u>320</u>
<u>920.59</u>	<u>370</u>	<u>929.08</u>	<u>350</u>	<u>935.73</u>	<u>380</u>	<u>936.63</u>	<u>326</u>	<u>938.15</u>	<u>282</u>	<u>938.90</u>	<u>316</u>	<u>939.59</u>	<u>320</u>
<u>920.60</u>	<u>371</u>	<u>929.09</u>	<u>346</u>	<u>935.80</u>	<u>380</u>	<u>936.64</u>	<u>326</u>	<u>938.17</u>	<u>416</u>	<u>938.91</u>	<u>316</u>	<u>939.60</u>	<u>320</u>
<u>920.61</u>	<u>369</u>	<u>929.10</u>	<u>346</u>	<u>935.81</u>	<u>388</u>	<u>936.66</u>	<u>416</u>	<u>938.19</u>	<u>416</u>	<u>938.94</u>	<u>316</u>	<u>939.61</u>	<u>322</u>
<u>920.62</u>	<u>370</u>	<u>929.11</u>	<u>345</u>	<u>935.82</u>	<u>376</u>	<u>936.92</u>	<u>253</u>	<u>938.20</u>	<u>392</u>	<u>938.95</u>	<u>316</u>	<u>939.62</u>	<u>322</u>
<u>920.63</u>	<u>371</u>	<u>929.12</u>	<u>345</u>	<u>935.83</u>	<u>376</u>	<u>936.93</u>	<u>253</u>	<u>938.23</u>	<u>293</u>	<u>938.96</u>	<u>312</u>	<u>939.63</u>	<u>322</u>
<u>920.64</u>	<u>372</u>	<u>929.13</u>	<u>345</u>	<u>935.84</u>	<u>379</u>	<u>936.94</u>	<u>254</u>	<u>938.24</u>	<u>293</u>	<u>938.97</u>	<u>312</u>	<u>939.64</u>	<u>322</u>
<u>920.65</u>	<u>372</u>	<u>929.14</u>	<u>345</u>	<u>935.86</u>	<u>385</u>	<u>936.95</u>	<u>254</u>	<u>938.25</u>	<u>280</u>	<u>938.98</u>	<u>314</u>	<u>939.65</u>	<u>322</u>
<u>920.66</u>	<u>373</u>	<u>929.15</u>	<u>346</u>	<u>935.87</u>	<u>385</u>	<u>936.96</u>	<u>250</u>	<u>938.26</u>	<u>280</u>	<u>938.99</u>	<u>314</u>	<u>939.66</u>	<u>322</u>
<u>920.67</u>	<u>372</u>	<u>929.16</u>	<u>346</u>	<u>935.88</u>	<u>385</u>	<u>936.97</u>	<u>252</u>	<u>938.27</u>	<u>308</u>	<u>939.00</u>	<u>313</u>	<u>939.67</u>	<u>320</u>
<u>920.68</u>	<u>372</u>	<u>929.17</u>	<u>350</u>	<u>935.89</u>	<u>385</u>	<u>936.98</u>	<u>252</u>	<u>938.28</u>	<u>308</u>	<u>939.01</u>	<u>313</u>	<u>939.68</u>	<u>320</u>
<u>920.69</u>	<u>373</u>	<u>929.18</u>	<u>347</u>	<u>935.90</u>	<u>357</u>	<u>936.99</u>	<u>297</u>	<u>938.29</u>	<u>308</u>	<u>939.02</u>	<u>315</u>	<u>939.69</u>	<u>322</u>
<u>920.70</u>	<u>369</u>	<u>929.19</u>	<u>334</u>	<u>935.91</u>	<u>356</u>	<u>937.00</u>	<u>309</u>	<u>938.30</u>	<u>308</u>	<u>939.03</u>	<u>315</u>	<u>939.70</u>	<u>322</u>
<u>920.71</u>	<u>370</u>	<u>929.20</u>	<u>334</u>	<u>935.92</u>	<u>356</u>	<u>937.28</u>	<u>339</u>	<u>938.31</u>	<u>308</u>	<u>939.04</u>	<u>262</u>	<u>939.71</u>	<u>323</u>
<u>920.72</u>	<u>371</u>	<u>929.21</u>	<u>334</u>	<u>935.93</u>	<u>330</u>	<u>937.30</u>	<u>344</u>	<u>938.32</u>	<u>416</u>	<u>939.07</u>	<u>255</u>	<u>939.72</u>	<u>323</u>
<u>920.73</u>	<u>369</u>	<u>929.22</u>	<u>301</u>	<u>935.94</u>	<u>330</u>	<u>937.31</u>	<u>344</u>	<u>938.33</u>	<u>293</u>	<u>939.08</u>	<u>255</u>	<u>939.73</u>	<u>319</u>
<u>920.74</u>	<u>370</u>	<u>929.23</u>	<u>301</u>	<u>935.95</u>	<u>330</u>	<u>937.40</u>	<u>300</u>	<u>938.34</u>	<u>295</u>	<u>939.11</u>	<u>255</u>	<u>939.74</u>	<u>319</u>
<u>920.75</u>	<u>371</u>	<u>929.24</u>	<u>301</u>	<u>935.97</u>	<u>330</u>	<u>937.41</u>	<u>300</u>	<u>938.35</u>	<u>416</u>	<u>939.12</u>	<u>255</u>	<u>939.75</u>	<u>319</u>
<u>920.76</u>	<u>372</u>	<u>929.25</u>	<u>301</u>	<u>935.98</u>	<u>330</u>	<u>937.42</u>	<u>300</u>	<u>938.36</u>	<u>416</u>	<u>939.13</u>	<u>257</u>	<u>939.76</u>	<u>319</u>
<u>920.77</u>	<u>372</u>	<u>929.26</u>	<u>302</u>	<u>935.99</u>	<u>330</u>	<u>937.43</u>	<u>300</u>	<u>938.37</u>	<u>416</u>	<u>939.14</u>	<u>257</u>	<u>939.77</u>	<u>321</u>
<u>920.78</u>	<u>373</u>	<u>929.27</u>	<u>302</u>	<u>936.01</u>	<u>331</u>	<u>937.44</u>	<u>300</u>	<u>938.39</u>	<u>392</u>	<u>939.15</u>	<u>257</u>	<u>939.78</u>	<u>321</u>
<u>920.79</u>	<u>372</u>	<u>929.28</u>	<u>302</u>	<u>936.02</u>	<u>331</u>	<u>937.45</u>	<u>300</u>	<u>938.45</u>	<u>336</u>	<u>939.16</u>	<u>258</u>	<u>939.79</u>	<u>321</u>
<u>920.80</u>	<u>372</u>	<u>929.33</u>	<u>364</u>	<u>936.03</u>	<u>331</u>	<u>937.46</u>	<u>292</u>	<u>938.46</u>	<u>336</u>	<u>939.17</u>	<u>258</u>	<u>939.80</u>	<u>321</u>
<u>920.81</u>	<u>373</u>	<u>929.34</u>	<u>364</u>	<u>936.05</u>	<u>331</u>	<u>937.51</u>	<u>284</u>	<u>938.47</u>	<u>336</u>	<u>939.19</u>	<u>258</u>	<u>939.81</u>	<u>321</u>
<u>921.02</u>	<u>337</u>	<u>929.35</u>	<u>364</u>	<u>936.06</u>	<u>331</u>	<u>937.53</u>	<u>304</u>	<u>938.48</u>	<u>336</u>	<u>939.20</u>	<u>258</u>	<u>939.82</u>	<u>321</u>
<u>921.05</u>	<u>337</u>	<u>929.36</u>	<u>364</u>	<u>936.07</u>	<u>331</u>	<u>937.54</u>	<u>289</u>	<u>938.49</u>	<u>336</u>	<u>939.21</u>	<u>256</u>	<u>939.83</u>	<u>321</u>
<u>922.09</u>	<u>357</u>	<u>929.37</u>	<u>365</u>	<u>936.25</u>	<u>328</u>	<u>937.56</u>	<u>305</u>	<u>938.50</u>	<u>336</u>	<u>939.22</u>	<u>256</u>	<u>939.84</u>	<u>321</u>
<u>924.96</u>	<u>393</u>	<u>929.38</u>	<u>365</u>	<u>936.26</u>	<u>328</u>	<u>937.57</u>	<u>305</u>	<u>938.57</u>	<u>312</u>	<u>939.23</u>	<u>249</u>	<u>939.85</u>	<u>323</u>
<u>924.97</u>	<u>393</u>	<u>929.39</u>	<u>365</u>	<u>936.27</u>	<u>328</u>	<u>937.59</u>	<u>289</u>	<u>938.58</u>	<u>312</u>	<u>939.24</u>	<u>249</u>	<u>939.86</u>	<u>323</u>
<u>924.98</u>	<u>393</u>	<u>929.40</u>	<u>365</u>	<u>936.28</u>	<u>329</u>	<u>937.61</u>	<u>396</u>	<u>938.59</u>	<u>312</u>	<u>939.26</u>	<u>261</u>	<u>939.92</u>	<u>284</u>
<u>924.99</u>	<u>393</u>	<u>929.41</u>	<u>369</u>	<u>936.29</u>	<u>329</u>	<u>937.62</u>	<u>396</u>	<u>938.60</u>	<u>312</u>	<u>939.27</u>	<u>261</u>	<u>939.93</u>	<u>284</u>
<u>925.35</u>	<u>349</u>	<u>929.42</u>	<u>370</u>	<u>936.30</u>	<u>329</u>	<u>937.64</u>	<u>297</u>	<u>938.61</u>	<u>312</u>	<u>939.28</u>	<u>261</u>	<u>939.94</u>	<u>261</u>
<u>925.43</u>	<u>349</u>	<u>929.43</u>	<u>366</u>	<u>936.31</u>	<u>330</u>	<u>937.65</u>	<u>294</u>	<u>938.62</u>	<u>312</u>	<u>939.29</u>	<u>261</u>	<u>939.96</u>	<u>251</u>
<u>926.21</u>	<u>334</u>	<u>929.44</u>	<u>366</u>	<u>936.32</u>	<u>330</u>	<u>937.67</u>	<u>296</u>	<u>938.63</u>	<u>314</u>	<u>939.30</u>	<u>261</u>	<u>939.97</u>	<u>251</u>
<u>926.25</u>	<u>334</u>	<u>929.45</u>	<u>367</u>	<u>936.33</u>	<u>330</u>	<u>937.74</u>	<u>294</u>	<u>938.64</u>	<u>314</u>	<u>939.31</u>	<u>261</u>	<u>939.99</u>	<u>262</u>
<u>926.28</u>	<u>334</u>	<u>929.46</u>	<u>366</u>	<u>936.35</u>	<u>390</u>	<u>937.75</u>	<u>294</u>	<u>938.65</u>	<u>314</u>	<u>939.34</u>	<u>250</u>	<u>940.03</u>	<u>139</u>
<u>926.93</u>	<u>352</u>	<u>929.47</u>	<u>366</u>	<u>936.36</u>	<u>390</u>	<u>937.76</u>	<u>295</u>	<u>938.66</u>	<u>314</u>	<u>939.35</u>	<u>250</u>	<u>940.79</u>	<u>135</u>
<u>926.94</u>	<u>352</u>	<u>929.48</u>	<u>367</u>	<u>936.37</u>	<u>390</u>	<u>937.77</u>	<u>296</u>	<u>938.67</u>	<u>314</u>	<u>939.36</u>	<u>359</u>	<u>940.80</u>	<u>135</u>
<u>927.05</u>	<u>353</u>	<u>929.49</u>	<u>367</u>	<u>936.39</u>	<u>331</u>	<u>937.81</u>	<u>277</u>	<u>938.68</u>	<u>314</u>	<u>939.37</u>	<u>359</u>	<u>940.83</u>	<u>126</u>
<u>927.06</u>	<u>353</u>	<u>929.50</u>	<u>368</u>	<u>936.40</u>	<u>331</u>	<u>937.82</u>	<u>277</u>	<u>938.69</u>	<u>313</u>	<u>939.38</u>	<u>359</u>	<u>940.88</u>	<u>132</u>
<u>927.26</u>	<u>351</u>	<u>929.51</u>	<u>368</u>	<u>936.41</u>	<u>331</u>	<u>937.83</u>	<u>290</u>	<u>938.70</u>	<u>313</u>	<u>939.39</u>	<u>359</u>	<u>940.89</u>	<u>132</u>
<u>927.27</u>	<u>351</u>	<u>929.52</u>	<u>367</u>	<u>936.43</u>	<u>390</u>	<u>937.84</u>	<u>290</u>	<u>938.71</u>	<u>313</u>	<u>939.40</u>	<u>358</u>	<u>940.90</u>	<u>133</u>

<u>940.93</u>	133	<u>941.83</u>	260	<u>952.95</u>	172	<u>954.59</u>	155	<u>976.53</u>	172	<u>979.43</u>	409	<u>997.38</u>	391
<u>940.96</u>	134	<u>941.84</u>	260	<u>952.96</u>	172	<u>954.61</u>	155	<u>976.54</u>	172	<u>979.45</u>	409	<u>997.39</u>	391
<u>940.97</u>	134	<u>941.85</u>	260	<u>953.09</u>	157	<u>954.62</u>	156	<u>976.55</u>	169	<u>979.46</u>	409	<u>997.42</u>	391
<u>941.05</u>	132	<u>941.86</u>	273	<u>953.10</u>	157	<u>954.63</u>	155	<u>976.56</u>	169	<u>979.73</u>	395	<u>997.43</u>	391
<u>941.06</u>	132	<u>941.87</u>	274	<u>953.11</u>	170	<u>954.64</u>	170	<u>976.57</u>	169	<u>979.83</u>	395	<u>998.12</u>	383
<u>941.07</u>	132	<u>941.88</u>	273	<u>953.15</u>	158	<u>954.65</u>	162	<u>976.79</u>	169	<u>979.85</u>	395	<u>998.14</u>	383
<u>941.08</u>	132	<u>941.95</u>	270	<u>953.16</u>	158	<u>954.66</u>	162	<u>976.82</u>	168	<u>984.02</u>	386	<u>998.15</u>	383
<u>941.09</u>	133	<u>941.96</u>	270	<u>953.17</u>	171	<u>954.67</u>	162	<u>976.83</u>	168	<u>984.07</u>	386	<u>998.16</u>	281
<u>941.10</u>	134	<u>941.97</u>	264	<u>953.18</u>	171	<u>954.68</u>	162	<u>976.84</u>	168	<u>984.32</u>	387	<u>998.17</u>	281
<u>941.13</u>	133	<u>941.98</u>	264	<u>953.19</u>	158	<u>954.69</u>	151	<u>976.85</u>	169	<u>984.49</u>	387	<u>998.18</u>	281
<u>941.15</u>	133	<u>941.99</u>	264	<u>953.20</u>	158	<u>954.70</u>	151	<u>976.86</u>	169	<u>984.62</u>	387	<u>998.25</u>	102
<u>941.19</u>	273	<u>942.04</u>	269	<u>953.21</u>	164	<u>954.71</u>	151	<u>976.87</u>	169	<u>984.66</u>	386	<u>998.42</u>	163
<u>941.31</u>	137	<u>942.05</u>	270	<u>953.22</u>	164	<u>954.72</u>	151	<u>976.88</u>	168	<u>984.71</u>	387	<u>998.65</u>	381
<u>941.32</u>	135	<u>942.06</u>	267	<u>953.23</u>	164	<u>954.73</u>	151	<u>977.01</u>	408	<u>984.74</u>	387	<u>998.67</u>	100
<u>941.33</u>	135	<u>942.07</u>	267	<u>953.24</u>	164	<u>954.74</u>	151	<u>977.03</u>	411	<u>987.54</u>	409	<u>998.68</u>	102
<u>941.34</u>	136	<u>942.08</u>	272	<u>953.25</u>	169	<u>954.75</u>	172	<u>977.15</u>	408	<u>987.56</u>	309	<u>998.88</u>	97
<u>941.35</u>	136	<u>942.09</u>	249	<u>953.26</u>	169	<u>954.76</u>	172	<u>977.20</u>	408	<u>987.68</u>	306	<u>998.89</u>	97
<u>941.36</u>	137	<u>942.10</u>	269	<u>953.27</u>	169	<u>954.77</u>	166	<u>977.23</u>	412	<u>987.72</u>	306	<u>998.90</u>	97
<u>941.37</u>	137	<u>942.11</u>	268	<u>953.28</u>	169	<u>954.78</u>	166	<u>977.24</u>	412	<u>987.73</u>	342	<u>998.91</u>	96
<u>941.38</u>	138	<u>942.12</u>	268	<u>953.29</u>	155	<u>954.79</u>	166	<u>977.25</u>	408	<u>987.77</u>	309	<u>998.92</u>	96
<u>941.39</u>	137	<u>949.98</u>	161	<u>953.30</u>	155	<u>954.80</u>	166	<u>977.26</u>	412	<u>987.81</u>	309	<u>998.93</u>	96
<u>941.41</u>	139	<u>949.99</u>	161	<u>953.31</u>	155	<u>954.81</u>	167	<u>977.27</u>	412	<u>988.45</u>	287	<u>998.94</u>	96
<u>941.42</u>	136	<u>950.16</u>	168	<u>953.33</u>	155	<u>954.82</u>	167	<u>977.28</u>	407	<u>988.46</u>	293	<u>998.95</u>	96
<u>941.43</u>	138	<u>950.73</u>	172	<u>953.35</u>	156	<u>954.83</u>	167	<u>977.29</u>	407	<u>988.47</u>	254,293,414	<u>998.96</u>	96
<u>941.44</u>	137	<u>950.77</u>	174	<u>953.36</u>	156	<u>954.84</u>	167	<u>977.32</u>	412	<u>988.48</u>	262	<u>998.97</u>	97
<u>941.45</u>	137	<u>950.86</u>	168	<u>953.37</u>	156	<u>954.85</u>	167	<u>977.33</u>	412	<u>988.49</u>	262	<u>998.98</u>	97
<u>941.46</u>	138	<u>951.25</u>	170	<u>953.38</u>	156	<u>954.86</u>	167	<u>977.34</u>	412	<u>988.50</u>	262	<u>998.99</u>	97
<u>941.47</u>	138	<u>951.26</u>	168	<u>953.39</u>	156	<u>954.90</u>	161	<u>977.36</u>	407	<u>988.68</u>	291	<u>999.00</u>	102
<u>941.48</u>	136	<u>951.36</u>	169	<u>953.42</u>	156	<u>954.92</u>	162	<u>977.37</u>	411	<u>988.69</u>	291	<u>999.05</u>	101
<u>941.51</u>	136	<u>951.40</u>	169	<u>953.43</u>	156	<u>954.93</u>	141,150	<u>977.38</u>	411	<u>988.70</u>	291	<u>999.06</u>	101
<u>941.52</u>	135	<u>951.54</u>	154	<u>953.44</u>	156	<u>954.94</u>	170	<u>977.39</u>	412	<u>988.71</u>	291	<u>999.07</u>	101
<u>941.53</u>	137	<u>951.55</u>	154	<u>953.51</u>	163	<u>954.95</u>	170	<u>977.43</u>	413	<u>988.75</u>	285	<u>999.08</u>	101
<u>941.54</u>	251	<u>951.77</u>	160	<u>953.52</u>	163	<u>954.96</u>	168	<u>977.44</u>	413	<u>988.76</u>	291	<u>999.09</u>	102
<u>941.55</u>	251	<u>951.82</u>	148	<u>953.53</u>	163	<u>954.97</u>	168	<u>977.45</u>	413	<u>988.77</u>	292	<u>999.10</u>	102
<u>941.56</u>	251	<u>951.83</u>	148,150	<u>953.54</u>	163	<u>954.98</u>	168	<u>977.46</u>	413	<u>988.78</u>	343	<u>999.20</u>	382
<u>941.57</u>	251	<u>951.85</u>	148	<u>953.55</u>	140,149	<u>955.01</u>	158	<u>977.47</u>	413	<u>988.91</u>	288	<u>999.21</u>	382
<u>941.58</u>	127	<u>951.86</u>	148	<u>953.56</u>	140,149	<u>955.02</u>	158	<u>977.48</u>	413	<u>988.92</u>	288		
<u>941.59</u>	127	<u>951.92</u>	173	<u>953.57</u>	140,149	<u>955.05</u>	157	<u>977.49</u>	413	<u>988.96</u>	284		
<u>941.60</u>	127	<u>951.93</u>	173	<u>953.58</u>	140,149	<u>968.31</u>	169	<u>977.50</u>	413	<u>988.97</u>	284		
<u>941.61</u>	126	<u>951.94</u>	174	<u>953.59</u>	140,149	<u>968.33</u>	168	<u>977.51</u>	407	<u>989.40</u>	343		
<u>941.62</u>	126	<u>951.95</u>	174	<u>953.62</u>	154	<u>968.34</u>	168	<u>977.53</u>	407	<u>989.43</u>	343		
<u>941.63</u>	126	<u>951.96</u>	174	<u>953.63</u>	154	<u>968.54</u>	168	<u>977.59</u>	414	<u>989.68</u>	342		
<u>941.64</u>	126	<u>951.97</u>	174	<u>954.34</u>	157	<u>968.85</u>	169	<u>977.60</u>	412	<u>989.71</u>	342		
<u>941.65</u>	260	<u>952.00</u>	159	<u>954.35</u>	157	<u>968.86</u>	169	<u>977.62</u>	409	<u>989.88</u>	303		
<u>941.66</u>	271	<u>952.04</u>	153	<u>954.36</u>	162	<u>971.1229</u>	138	<u>977.67</u>	409	<u>990.68</u>	100		
<u>941.67</u>	271	<u>952.05</u>	153	<u>954.37</u>	162	<u>971.229</u>	138	<u>977.71</u>	408	<u>990.79</u>	99		
<u>941.69</u>	272	<u>952.69</u>	153	<u>954.38</u>	163	<u>972.78</u>	409	<u>977.81</u>	408	<u>990.86</u>	99		
<u>941.70</u>	266	<u>952.70</u>	153	<u>954.40</u>	163	<u>972.83</u>	143	<u>977.82</u>	408	<u>990.88</u>	99		
<u>941.72</u>	265	<u>952.71</u>	153	<u>954.42</u>	163	<u>974.74</u>	170	<u>978.019</u>	143	<u>990.89</u>	98		
<u>941.73</u>	265	<u>952.72</u>	153	<u>954.43</u>	163	<u>975.38</u>	411	<u>978.029</u>	142	<u>991.00</u>	99		
<u>941.74</u>	266	<u>952.73</u>	153	<u>954.50</u>	161	<u>975.99</u>	168	<u>978.41</u>	143	<u>993.33</u>	338		
<u>941.75</u>	259	<u>952.82</u>	170	<u>954.51</u>	161	<u>976.02</u>	159	<u>978.44</u>	143	<u>993.42</u>	338		
<u>941.76</u>	259	<u>952.83</u>	153	<u>954.52</u>	165	<u>976.03</u>	159	<u>978.45</u>	143	<u>993.43</u>	338		
<u>941.77</u>	259	<u>952.85</u>	154	<u>954.53</u>	165	<u>976.04</u>	159	<u>979.047</u>	142	<u>993.80</u>	98		
<u>941.78</u>	259	<u>952.86</u>	154	<u>954.54</u>	165	<u>976.05</u>	159	<u>979.055</u>	142	<u>993.81</u>	98		
<u>941.79</u>	259	<u>952.91</u>	152	<u>954.55</u>	152	<u>976.12</u>	154	<u>979.057</u>	142	<u>993.85</u>	98		
<u>941.80</u>	259	<u>952.92</u>	152	<u>954.56</u>	152	<u>976.13</u>	154	<u>979.069</u>	142	<u>994.95</u>	303		
<u>941.81</u>	259	<u>952.93</u>	152	<u>954.57</u>	160	<u>976.48</u>	169	<u>979.32</u>	409	<u>996.79</u>	100		
<u>941.82</u>	259	<u>952.94</u>	172	<u>954.58</u>	160	<u>976.49</u>	169	<u>979.41</u>	409	<u>996.80</u>	100		



**A**

**ÖSTERREICH**

Paulmann Ges.m.b.H  
Linzerstrasse 89-91  
A-3003 Gablitz  
☎ +43 2231 66492  
✉ +43 2231 6649217  
info@paulmann.at

**AND**

**ANDORRA**

Paulmann Iluminación S.L.U.  
Ctra.Barcelona, nº 150 – Local 4  
ES- 08205 Sabadell (Barcelona)  
☎ +34 937279533  
✉ +34 937255953  
info@paulmann.es

**B**

**BELGIË**

VSA  
Hagelberg 29  
B-2440 Geel  
☎ +31 499 551460  
✉ +31 499 575795  
Paulmann@vanspijk.nl

**BG**

**БЪЛГАРИЯ**

Mankovski Ltd.  
16 Ana Feliksova Street  
Orchid Hills, bl. 2, fl. 4, ap. 14  
9000 Varna  
☎ +359 886654093  
i\_mankovski@abv.bg

**BIH**

**BOSNIA-HERCEGOVINA**

Mikrut D.O.O.  
Maciej Mikrut  
Ulica Ivana Pengova 18  
SI- 1230 Domzale  
☎ +386 31518153  
✉ +386 17219514  
mmikrut@paulmann.si

**CH**

**SCHWEIZ**

Puag AG  
Oberebenstrasse 51  
CH-5620 Bremgarten  
☎ + 41 56 648 88 48  
✉ + 41 56 648 88 80  
info@puag.ch

**CY**

**ΚΥΠΡΟΣ**

ΕΛΕΚΤΡΟΪΜΠΕΞ ΕΛΛΑΣ Α.Ε.  
Δερβενίων & Ποσειδώνος  
GR-14410 Μεταμόρφωση  
☎ +30 2102819783  
✉ +30 2102819385  
info@electroimpex.gr

**CZ**

**ČESKÁ REPUBLIKA**

Ing. Radek Brada  
Za Sídlištěm 450  
CZ-25241 Dolní Břežany  
☎ +420 602331140  
✉ +420 241416267  
brada.radek@volny.cz

AULIX lighting spol. s r.o.  
U Náměstí 708  
252 41 Dolní Břežany  
Mobil: +420 702 053 063  
Tel.: +420 241 402 565  
E-mail: info@aulix.cz  
Czech republic

**D**

**DEUTSCHLAND**

Paulmann Licht GmbH  
Quezinger Feld 2  
31832 Springe Völkxen  
☎ +49 5041 998-0  
✉ +49 5041 998-119  
info@paulmann.de

**DK**

**DANMARK**

SB Butiksservice  
Radhustorvet 11  
DK-8700 Horsens  
☎ +45 7023 2730  
✉ +49 7023 2703  
mb@sb.dk

**E**

**ESPAÑA**

Paulmann Iluminación S.L.U.  
Ctra.Barcelona, nº 150 – Local 4  
ES- 08205 Sabadell (Barcelona)  
☎ +34 937279533  
✉ +34 937255953  
info@paulmann.es

**EST**

**EESTI**

SIA Paulmann-Gaisma  
Gertrudes lela 53-1A  
LV- 1011 Riga  
☎ +371 67280542  
✉ +371 67542413  
Paulmann@latnet.lv

**F**

**FRANCE**

Paulmann Lumière S.A.  
21, rue Desaix- CS 21076  
F-67452 Mundolsheim Cedex  
☎ +33 3 90203737  
✉ +33 3 90203757  
comm@paulmann.fr

**FIN**

**SUOMI (FINLAND)**

Hedengren Yhtioet  
OY HedTec Ab  
Maenkimiehentie 4  
02780 ESPOO  
☎ +358 9 68288202  
✉ +358 9 673813  
lighting@hedtec.fi

**FL**

**LIECHTENSTEIN**

Puag AG  
Oberebenstrasse 51  
CH-5620 Bremgarten  
☎ +41/56-6488855  
✉ +41/56-6488850  
info@puag.ch

**GB**

**UNITED KINGDOM**

Light Source Europe Ltd.  
6 Great Western Business Park  
McKenzie Way  
Worcester  
WR4 9PT  
☎ +44 1905 22243  
✉ +44 1905 611263  
sales@lselectlighting.com

**GR**

**ΕΛΛΑΔΑ**

ΕΛΕΚΤΡΟΪΜΠΕΞ ΕΛΛΑΣ Α.Ε.  
Δερβενίων & Ποσειδώνος  
GR-14410 Μεταμόρφωση  
☎ +30 210 2819783  
✉ +30 210 2819385  
info@electroimpex.gr

**H**

**MAGYARORSZÁG**

DINOCoop GmbH  
Radvány u. 24  
1118 Budapest XI  
☎ +36-1-3193064  
✉ +36-1-3193066  
dinocoop@dinocoop.hu

**HR**

**HRVATSKA**

Mikrut D.O.O.  
Maciej Mikrut  
Ulica Ivana Pengova 18  
SI- 1230 Domzale  
☎ +386 31518153  
✉ +386 17219514  
mmikrut@paulmann.si

**I**

**ITALIA**

TreEsse SRL  
Via Campanella 65  
50019 Sesto Fiorentino  
(Florenz)  
☎ +39 055 4252687  
✉ +39 055 4211598  
elena@treessesrl.com

**IS**

**ISLAND**

Johann Olafsson & Co  
Krokhals 3  
IS-110 Reykjavik  
☎ +354- 5331904  
✉ +354- 5331901  
jarni@olafsson.is

**L**

**LUXEMBOURG**

VSA  
Hagelberg 29  
B-2440 Geel  
☎ +31 499 551460  
✉ +31 499 575795  
Paulmann@vanspijk.nl

**LT**

**LIETUVA**

SIA Paulmann-Gaisma  
Gertrudes lela 53-1A  
LV- 1011 Riga  
☎ +371 67280542  
✉ +371 67542413  
Paulmann@latnet.lv

**LV**

**LATVIJA**

SIA Paulmann-Gaisma  
Gertrudes lela 53-1A  
LV- 1011 Riga  
☎ +371 67280542  
✉ +371 67542413  
paulmann@latnet.lv

**MK**

**MAKEDONIJA**

DPTUU „EL-LUKS“ DOOEL  
ul.: Leninova br. 79  
MK-2400 Strumica  
☎ +389 75 301 109  
✉ +389 34 320 133  
info@el-lux.com.mk

**MNE**

**CRNA GORA**

HIDRO NEON DOO  
Ive Lole Ribara 13  
SRB-23232 Torak  
☎ +381-21-505 790  
✉ +381-21-520 156  
peraneon@eunet.rs

**N**

**NORGE**

Lyskomponenter AS  
Sagmyra 2A  
N-4624 Kristiansand S  
☎ +47 38003636  
✉ +47 38003639  
firmapost@lyskomponenter.no

**NL**

**NEDERLAND**

VSA  
De Scheper 402  
NL-5688HP Oirschot  
☎ +31 499 551460  
✉ +31 499 575795  
Paulmann@vanspijk.nl

**P**

**PORTUGAL**

Paulmann Iluminación S.L.U.  
Ctra.Barcelona, nº 150 – Local 4  
ES- 08205 Sabadell (Barcelona)  
☎ +34 937279533  
✉ +34 937255953  
info@paulmann.es

**PL**

**POLSKA**

“LŁ” Spółka z ograniczoną  
odpowiedzialnością sp. k.  
ul. Wrocławska 43 Byków;  
55-095 Mirków  
☎ +48 71 39 80 800  
✉ +48 71 39 80 802  
paulmann@langelukaszuk.pl

**RO**

**ROMANIA**

Atrium Design SRL  
Str. Balciului, no.1  
Sector 2,  
RO-021501 Bucharest  
☎ +40 21 252 4653  
✉ +40 21 252 4654  
atrium@atrium.ro

**RUS**

**РОССИЯ**

Лайт Капитал 000  
ул.Выборгская д.16  
стр.1 оф.А809  
125212, г.Москва  
☎ +7 495 514-19-08  
✉ +7 495 514-19-08  
info@paulmann.ru

**S**

**SVERIGE**

Paulmann Licht GmbH  
Quezinger Feld 2  
D-31832 Springe  
☎ +49 5041 998-0  
✉ +49 5041 998-169  
info@paulmann.de

**SK**

**SLOVAKIA**

Ing. Radek Brada  
Za Sídlištěm 450  
CZ-25241 Dolní Břežany  
☎ +420 602331140  
✉ +420 241416267  
brada.radek@volny.cz

AULIX lighting spol. s r.o.  
U Náměstí 708  
252 41 Dolní Břežany  
Mobil: +420 702 053 063  
Tel.: +420 241 402 565  
E-mail: info@aulix.cz  
Czech republic

**SLO**

**SLOVENIJA**

Mikrut D.O.O.  
Maciej Mikrut  
Ulica Ivana Pengova 18  
SI- 1230 Domzale  
☎ +386 31518153  
✉ +386 172 19514  
mmikrut@paulmann.si

**SRB**

**REPUBLIKA SRBIJA**

HIDRO NEON DOO  
Ive Lole Ribara 13  
SRB-23232 Torak  
☎ +381-21-505 790  
✉ +381-21-520 156  
peraneon@eunet.rs

**TR**

**TÜRKIYE**

Paulmann Licht GmbH  
Quezinger Feld 2  
D-31832 Springe  
☎ +49 5041 998-0  
✉ +49 5041 998-169  
info@paulmann.de



Bemaßung von Artikeln  
Dimension des articles  
Maten van de artikelen

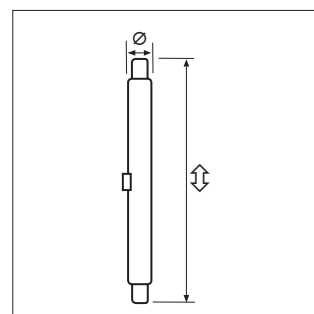
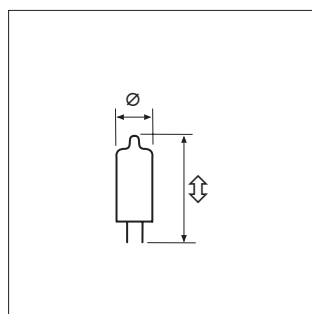
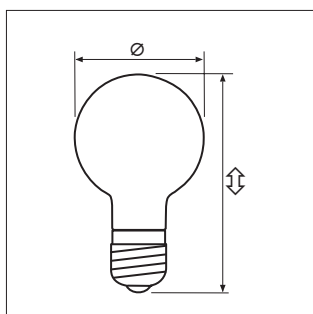
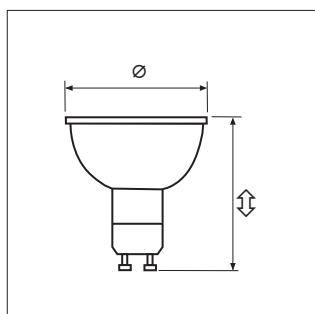
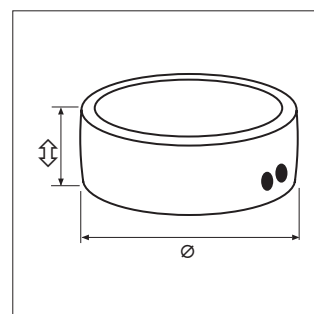
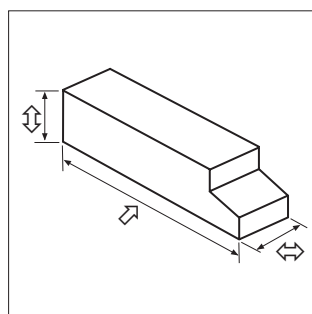
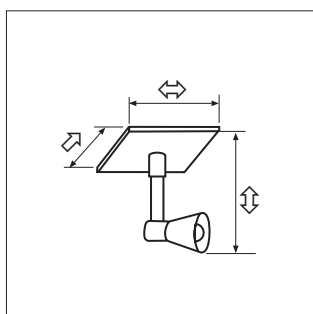
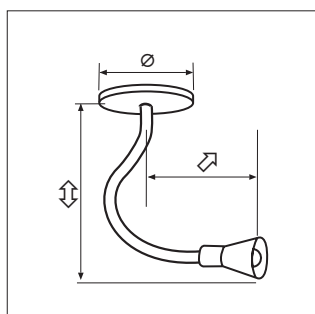
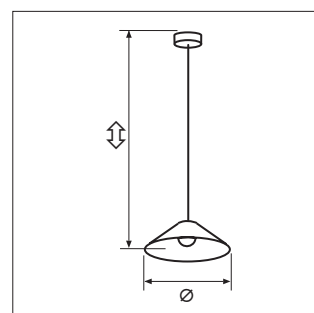
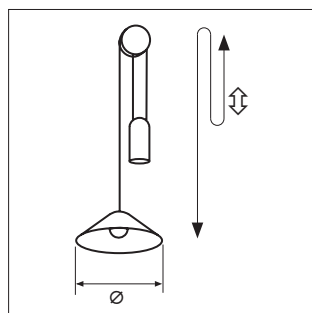
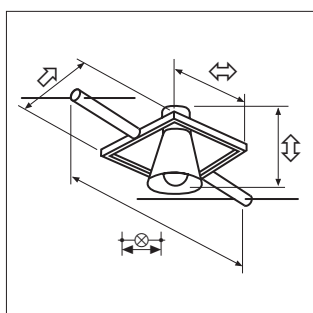
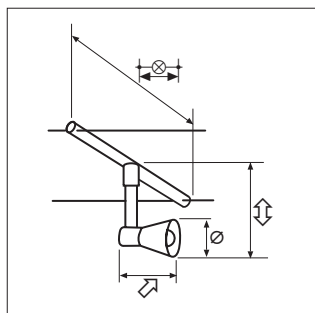
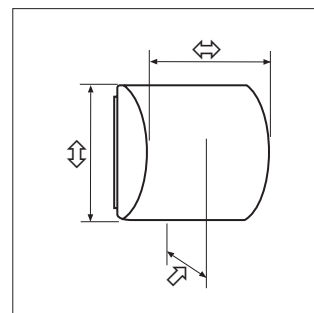
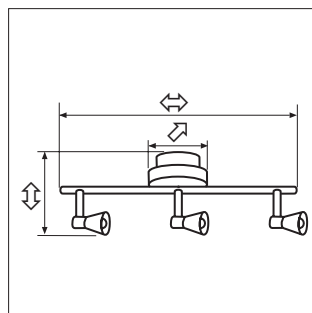
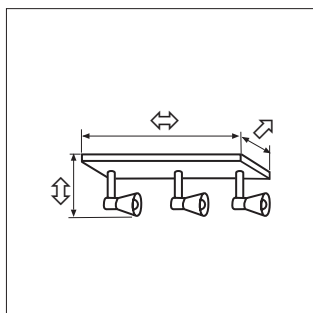
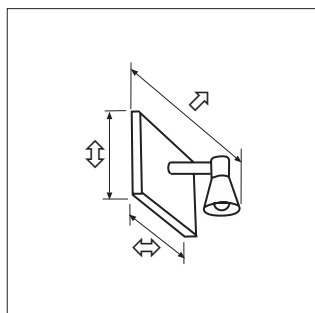
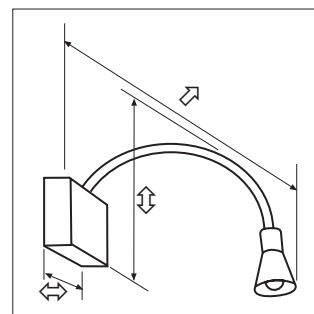
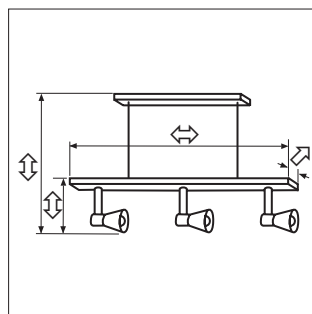
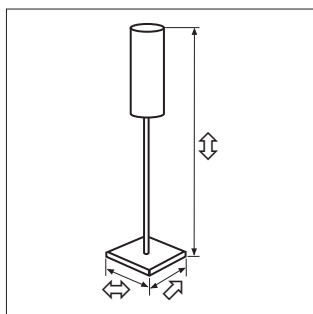
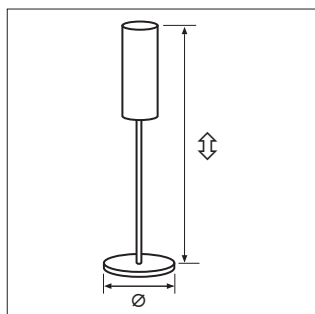



**D**

**Garantiebedingungen Paulmann Licht GmbH**

Die Paulmann Licht GmbH garantiert nichtgewerblichen Kunden die einwandfreie Funktion der mit einem entsprechenden Garantievermerk ausgezeichneten Produkte für einen Zeitraum von 5 Jahren ab Kauf. Unsere vollständigen Garantiebedingungen finden Sie auf unserer Website: [www.paulmann.com/guarantee](http://www.paulmann.com/guarantee)



Sicherheitsprüfzeichen des Verband Deutscher Elektrotechniker und der Technischen Überwachungsvereine. Paulmann steht für höchste Sicherheit und Qualität. Alle unsere Artikel entsprechen den festgelegten europäischen Normen. Paulmann Artikel sind, auch wenn eine Sicherheitsprüfung nicht zwingend vorgeschrieben ist, von VDE, TÜV oder Paulmann Qualitäts-sicherung geprüft. Diese sind im Katalog entsprechend gekennzeichnet.

150 VA

Das VDE-Zeichen hinter der Trafoangabe (z. B. 105 VA) bezieht sich nur auf den Trafo, nicht auf das Produkt.

Alle Abbildungen und Angaben bezüglich Maße, Farbe usw. unterliegen eventuellen produktionstechnischen Toleranzen und sind unverbindlich. Produktänderungen behalten wir uns jederzeit vor. Wir arbeiten auf der Grundlage unserer Liefer- und Zahlungsbedingungen. Diese erhalten Sie gerne auf Anfrage oder unter [www.paulmann.com](http://www.paulmann.com)

832.xx

Alle angegebenen Leuchtmittel bei den Produkten empfehlen wir zum Nachkauf.



Unsere Produkte aus Naturwerkstoffen und handgefertigten Gläsern sind einzigartig, sie unterliegen natürlichen Schwankungen in Farbe und Struktur.



Farbe



Material



Schutzklasse 2



Schutzklasse 3



Kaltlichtspiegel



Niederdruck



Produkt mit begrenzter Oberflächen-temperatur



Die Leuchte ist nur geeignet zur Montage auf nicht entflammaren Materialien.



Schutzarten IP  
Erläuterungen siehe Seite 481

**F**

**Conditions de garantie de Paulmann Licht GmbH**

La société Paulmann Licht GmbH garantit aux clients résidentiels le fonctionnement impeccable des produits comportant la signalisation de garantie correspondante pendant 5 ans à compter de la date d'achat. L'ensemble de nos conditions de garantie est disponible sur notre site Web : [www.paulmann.com/guarantee](http://www.paulmann.com/guarantee)

Symboles de sécurité de l'association des électrotechniciens allemands et des organismes de contrôle technique. Paulmann est synonyme de qualité et de sécurité optimales. Tous nos articles sont conformes aux normes européennes applicables. Les articles Paulmann sont contrôlés par le VDE, le TÜV ou par le service d'assurance qualité Paulmann, même lorsque le contrôle de sécurité n'est pas impérativement prescrit. Ces contrôles sont marqués de repères dans le catalogue.

Le symbole VDE figurant derrière l'indication du transformateur (par exemple 105 VA) ne concerne que le transformateur, et non le produit.

Toutes les illustrations et les indications relatives aux dimensions, aux couleurs, etc. peuvent éventuellement présenter des différences du fait des techniques de production et n'ont aucun caractère d'engagement. Nous nous réservons le droit d'apporter des modifications aux produits à tout moment. Nous travaillons sur la base de nos conditions de livraison et de paiement. Vous pouvez les obtenir sur simple demande ou en consultant le site Internet [www.paulmann.com](http://www.paulmann.com)

Nous recommandons les ampoules devant être achetées ultérieurement pour les différents produits.

Nos produits en matériaux naturels et verres fabriqués à la main sont uniques et sont soumis aux variations naturelles chromatiques et structurelles.

couleur

matériau

Classe de protection 2

Classe de protection 3

Dichroïque

Basse pression

Produit avec température de surface limitée

L'ampoule convient uniquement pour être montée sur des matériaux non inflammables.

Types de protection IP  
Explications voir page 481

**NL**

**Garantievoorwaarden Paulmann Licht GmbH**

Paulmann Licht GmbH garandeert niet-commerciële klanten de onberispelijke werking van de met een overeenkomstig garantiebewijs gekenmerkte producten gedurende 5 jaar vanaf datum van aankoop. Onze volledige garantievoorwaarden vindt u op onze website: [www.paulmann.com/guarantee](http://www.paulmann.com/guarantee)

Keurmerk van de VDE en de TÜV. Paulmann staat garant voor de hoogste mate van veiligheid en kwaliteit. Al onze artikelen voldoen aan de vastgestelde Europese normen. Ook als het niet voorgeschreven is, zijn de Paulmann artikelen gecontroleerd door de VDE, TÜV of de kwaliteitsafdeling van Paulmann. Deze artikelen zijn in de catalogus gekentekend.

Het VDE-keurmerk achter de transformator informatie bijv. 105 VA) heeft uitsluitend betrekking op de trafo, niet op het product.

Alle afbeeldingen en gegevens met betrekking tot maten, kleur enz. kunnen om productietechnische redenen afwijken en zijn vrijblijvend. Productwijzigingen behouden wij ons ten alle tijden voor. Wij werken op basis van onze leverings- en betalingsvoorwaarden. Deze verkrijgt op aanvraag of onder [www.paulmann.com](http://www.paulmann.com)

Alle aangegeven lampen bij de producten aanbevolen voor latere aankoop.

Onze producten van natuurlijke materialen en handgemaakt glas zijn uniek. Ze zijn in kleur en structuur onderhevig aan natuurlijke schommelingen.

Kleur

Materiaal

Beveiligingsklasse 2

Beveiligingsklasse 3

Koudlichtspiegel

Lagedruk

Product met maximale oppervlaktetemperatuur

De lamp is uitsluitend geschikt voor montage op niet ontvlambare materialen.

Beveiligingsklassen IP  
Verklaringen zie pagina 481



	Rostfrei	Inoxydable	Roestvrij
	2 Helligkeitsstufen	2 niveaux de luminosité	2 Lichtsterktes
	Dämmerungs-Sensor	Capteur crépusculaire	Schemerings-sensor
	RGB-Multicolor Farbwechsel	Changement de couleur RGB multicolore	RGB-Multicolor kleurwisseling
	LED-Farbe Rot, Grün oder Blau	LED rouge, verte ou bleue	LED-kleur rood, groen of blauw
	einstellbare Farben	Couleurs réglables	Instelbare kleuren
	blinkend	Clignotant	Knipperend
	Freeze-Funktion	Fonction Freeze	Freeze-functie
	Flashlight-Funktion	Fonction Flash	Flashlight-functie
	Sound-Sensor	Capteur son	Sound-sensor
	Mit Schalter	Avec commutateur	Met schakelaar
	Mit Kabel-Schalter inkl. Stecker	Avec commutateur de câble, y compris fiche mâle	Met kabelschakelaar incl. stekker
	Mit Touch-Dimmer	Avec variateur de contact (touch-dimmer)	Met touch-dimmer
	Mit Dimmer	Avec variateur	Met dimmer
	Dimmbar	à intensité variable	dimbaar
	Bajonettverschluss	Fermeture à baïonnette	Bajonetsluiting
	Mit Steckertrafo	Avec transformateur à brancher	Met stekkertrafo
	Stecker inklusive Schutzkontakt (Deutschland)	Fiche de prise de courant, contact de mise à la terre compris (Allemagne)	Stekker inclusief randaarding (Duitsland)
	Mit Steckverbinder	Avec connecteur enfichable	Met stekkerverbinding
	Mit Fernbedienung	Avec télécommande	Met afstandsbediening
	Bewegungsmelder mit Hochfrequenz-Sensor	Détecteur de mouvement avec capteur HF	Bewegingsmelder met sensor hoge frequentie
	Bewegungsmelder	Détecteur de mouvement	Bewegingsmelder
	Bewegungsmelder mit Näherungssensor	Détecteur de mouvement avec capteur de proximité	Bewegingsmelder met naderingssensor
	Batterie-, Akku-, Batterie und Akku-Betrieb möglich	Fonctionnement possible sur piles, sur accumulateurs, sur piles et accumulateurs	Gebruik met batterijen, met accu en met batterijen en accu mogelijk
	Batterie/Akku enthalten	Pile/accumulateur compris(e)	Inclusief batterij/accu
	Wand-, Boden- und/oder Deckenmontage	Montage mural/au sol et/ou au plafond	Wand-, vloer- en/of plafondmontage
	max. Belastung	Charge max.	max. belasting
	Seil-/Stangenabstand	Distance de câble/rail	Kabel-/stangenafstand
	Sockel	Socle	Bodemplaat
lm	Lumen, Lichtstrom Erläuterungen siehe Seite 477, 482	lumen, flux lumineux Explications voir page 477, 482	Lumen, lichtstroom Verklaringen zie pagina 477, 482
lm <sub>/90°</sub> lm <sub>/120°</sub>	Helligkeit bei Reflektorlampen Erläuterungen siehe Seite 482	Luminosité d'un réflecteur Explications voir page 482	Helderheid bij reflectorlampen Verklaringen zie pagina 482
K	Kelvin, Farbtemperatur Erläuterungen siehe Seite 483	Kelvin, température de couleur Explications voir page 483	Kelvin, kleurtemperatuur Verklaringen zie pagina 483
cd	Candela (Lux) Wert auf 1 m Erläuterungen siehe Seite 483	Candela (Lux) à 1 m Explications voir page 483	Candela (Lux) waarde per 1 m Verklaringen zie pagina 483
S	Scheinleistung Erläuterungen siehe Seite 480	Puissance apparente Explications voir page 480	Schijnvermogen Verklaringen zie pagina 480
	Einfache Montage	Montage simple	Eenvoudige montage



	Verwendung nur im Innenbereich	Utilisation intérieure uniquement	Gebruik alleen binnenshuis
	Ringkerntrafo	Transformateur toroïda	Ringkerntrafo
	Dimmbar mit PhasenANSchnittdimmer Erläuterungen siehe Seite 479	Variateur d'intensité de phase Explications voir page 479	Dimbaar met fase-Afsnijdingsdimmer Verklaringen zie pagina 479
	Dimmbar mit PhasenABSchnittdimmer Erläuterungen siehe Seite 479	Variateur d'intensité de section Explications voir page 479	Dimbaar met fase-Afsnijdingsdimmer Verklaringen zie pagina 479
	Integrierter Funkschutz	Protection radio intégrée	Ingebouwde radio ontstoring
	Integrierter Softstart	Démarrage soft intégré	Ingebouwde softstart
	Integrierter Kurzschluss-Schutz	Protection intégrée contre les courts-circuits	Ingebouwde kortsluitingsbeveiliging
	Erhöhter Spikeschutz	Protection Spike supérieure	Verhoogde spikebescherming
	Integrierter Brandschutz	Protection incendie intégrée	Ingebouwde brandbeveiliging
	Integrierter Überlastschutz	Protection intégrée contre les surcharges	Ingebouwde overbelastingsbeveiliging
	Integrierter wiedereinschaltbarer Temperaturwächter	Sonde thermique intégrée réenclenchable	Ingebouwde en schakelbare temperatuurbewaker
	Integrierter Temperaturwächter und elektronische Sicherung	Sonde thermique intégrée et fusible électronique	Ingebouwde temperatuurbewaker en elektronische zekering
	Integrierte elektronische Sicherung	Sonde thermique intégrée et fusible électronique	Ingebouwde elektronische zekering
	Integrierte Feinsicherung	Fusible électronique intégré	Ingebouwde fijnzekering
	SB-Verpackung	Emballage SB	Showverpakking voor haak
	Verpackungseinheit	Unité d'emballage	Verpakkingseenheid
	Energieeffizienzklasse	Classe d'efficacité énergétique	Energie-efficiëntieklasse
	Schaltzyklen	cycles de commutation	Schakelcycli
	Weniger Stromverbrauch, gleiche Helligkeit	Consommation électrique réduite, luminosité identique	Minder stroomverbruik, dezelfde helderheid
	flackerfreier Sofortstart	Allumage instantané sans clignotement	Directe inschakeling zonder flakkeren
	Lebensdauer	Durée de vie	Levensduur
	Lebensdauer elektronisches Vorschaltgerät	Durée de vie du ballast électronique	Levensduur elektronisch voorschakelapparaat
	Nicht für Allgemeinbeleuchtung, nur für Dekorationszwecke oder Spezialanwendungen	Ne convient pas à l'éclairage des pièces de vie, convient uniquement pour la décoration ou des applications spécifiques	Niet voor algemene verlichting, alleen voor decoratieve doeleinden of speciale toepassingen
	Textilkabel	Câble en textile	Textielkabel
	Dimmbar mit Smart Home App	Gradable avec Smart Home App	Dimbaar met Smart Home-app
	Tunable white	Tunable white	Tunable white
	OLED	OLED	OLED
	Mit USB-Stecker	Avec fiche USB	Met USB-stekker
	Mit USB-Anschluß	Avec prise USB	Met USB-aansluiting
	mit Stufen-Dimmer	Variateur à niveaux	trappen dimmer
	Schutzkontaktsteckdose	Prise de terre	Gearde stekker
	variabel verstellbar	réglage variable	variabel verstelbaar
	einmalig kürzbar	pouvant être raccourci une fois	een keer inkortbaar



